

Industrial Endoscope

User Manual

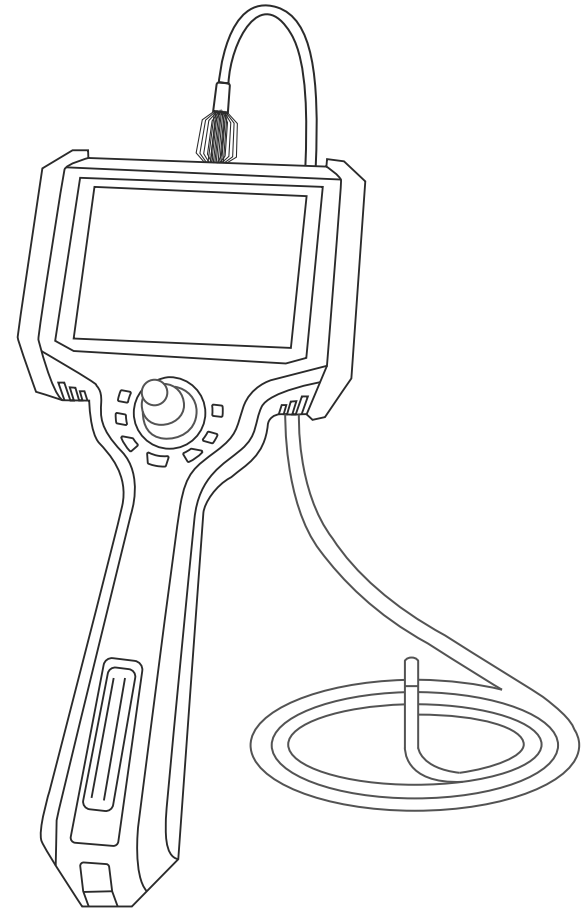

Warn up: Please read the user manual carefully before using the borescope

Copyright announcement

This manual applies to industrial video endoscope series products, the copyright belongs to our company, this specification and any information contained therein shall not be provided to any person without the written consent of the company any material to be copied, copied or translated into another language. We will hold those who violate the law accountable.

Warning:

Due to the continuous update of product technology, the market changes rapidly, and the editing time is limited, there is no guarantee that it is not included in this manual there are errors, so this manual is only for the reference of the user, do not provide any form of warranty. Our company reserves the right the content of this article is revised and changed right. The company has no obligation or obligation to notify any of the amendments.

- 1、 User Instructions**
 - 1.1 Application and scope of application 01
 - 1.2 Maintenance and modification 01
 - 1.3 Safety precautions 01

- 2、 Introduction of Industrial borescope Products**
 - 2.1 System parameters 02
 - 2.2 Operating environment 03
 - 2.3 Packing list 03

- 3、 Operation process** 04

- 4、 Instructions**
 - 4.1 Preparation before startup 04
 - 4.2 Bending control 04
 - 4.2.1 Key, interface introduction 05
 - 4.3 Storage/Video 07
 - 4.4 Instrument Observation Mode Quick Start Guide 08

- 5、 Turn off** 15

- 6、 Instrument storage mode** 15

- 7、 Troubleshooting** 15

1. User Instructions

1.1 Purpose and scope of application

This borescope is mainly used in public security, armed police, fire protection, procuratorate, customs and related security departments, and can assist in criminal investigation, eod, security inspection, anti-smuggling, search and rescue and other related testing work.

This borescope has the characteristics of light weight, high strength, single-person operation, easy to carry, simple operation, sturdy and durable, strong concealment and high reliability. Covert reconnaissance, real-time surveillance, record storage and image analysis provide powerful evidence for analyzing criminal investigation scenes and law enforcement forensics.

1.2 Purpose and scope of application

This product does not have any parts that can be maintained by the user, do not attempt to disassemble, refit and repair, the repair service of this product is only provided by our company and our com - pany authorized dealer repair.

1.3 Safety Precautions (Please observe the following when using this product)

- It is forbidden to use this instrument to observe the body of the human body or animal, otherwise the consequences will be at your own risk.
- It is forbidden to use or store in places with explosive, strong electromagnetic fields and flammable gas, which may cause fire or explosion.
- It is forbidden to operate the detected object under power conditions, so as not to cause electric shock.
- It is forbidden to turn on visible light and near-infrared lighting directly to the human eye within 5m.
- It is forbidden to use the camera probe to observe the sun or objects such as hot and high brightness, so as not to damage the CMOS camera.
- It is forbidden to directly touch the end of the lens after the sight glass is used in a high temperature environment. Touching the end at this time may cause burns
- Do not look directly at the strong light source emitted by the LED at the end of the observation mirror probe at close range to avoid the strong light affecting vision.

2. Video Observation Glass Product Introduction

2.1 System parameters

Bend Control	360°full way articulation
Probe Material	Tungsten wire braided
System language	Chinese (simplified), French, English, German Spanish, Italian, Japanese
Screen Size	5.0 inch industrial LCD screen
Image/Video format	JPEG/AVI
Host Structure	All-in-one handheld design
Storage	32G TF Card(max 128GB)
Data Port	Micro-USB port. HDMI video output port
IP grade	Probe insertion tube IP67, host IP54
Host working time	≥4H
System weight	≤0.8kg(with battery)
Power supply	Rechargeable lithium battery (removable)
Pixel	450000/1000000 pixel
View Angle	75 /80
Lighting method	White/Red illumination
Night vision distance	10m-18m
Video	Front video recording function(optional)
Infrared wavelengths	No red exposure 940nm, red exposure 850nm

2.2 Operating environment

Host system working temperature	-10°C~50°C
Video probe working temperature	-20°~80°C, Below 0°,Steering operations should be reduced
Storage temperature	-20°C~60°C(Host)
Relative humidity	Max 90%,no condensation

2.3 Packing List

Series Number	Description	Number	Unit
1	Host	1	PCS
2	Endoscope Probe	1	PCS
3	Card reader	1	PCS
4	TF card(32G)	1	PCS
5	Battery	1	PCS
6	Packing cast	1	PCS
7	Charging adapter	1	PCS
8	Micro USB cable	1	PCS
9	HDMI cable	1	PCS
10	User Manual	1	PCS
11	Certificate card	1	PCS
12	Warranty card	1	PCS

3. Operating procedures

3.1 Take out the instrument:

Open the outer box of the instrument, take out the endoscope host and hold the probe tightly to avoid collision and scratching probe head.

3.2 Preparation for startup:

Load the battery and insert the tf card.

3.3 Press the power button to start the machine.

3.4 Use of endoscope:

Insert end of endoscope tube into the product under test.

3.5 Angle operation:

operate the joystick to control the bending of the probe according to the requirements of field testing.

If the rocker suddenly encounters great resistance during shaking, or if there is any abnormality during the operation of the endoscope, please click Stop watching immediately. After shaking the rocker to the middle position, carefully remove the endoscope insert end from the inside of the product under test.

3.6 Exit:

Make sure that the endoscope is bent in a roughly flat position (the rocker is in the middle position), and then slowly move it to exit.

3.7 After use:

turn off the power switch, put the endoscope into the portable box, and coil the inserted tube. (e.g., for a long time no use instrument, please remove the battery).

4. Operation guide

4.1 Preparation before starting up

Take out the endoscope and insert the TF card. The probe should be used as straight as possible. Probes are prohibited from winding.

4.2 Bending control

The endoscope bending angle control is directly controlled by the rocker on the operation panel, and the direction of the rocker swing is probe. The direction of head rotation and the size of the corner is determined by the angle at which the joystick is shaken.

4.2.1 Buttons, Interface Introduction

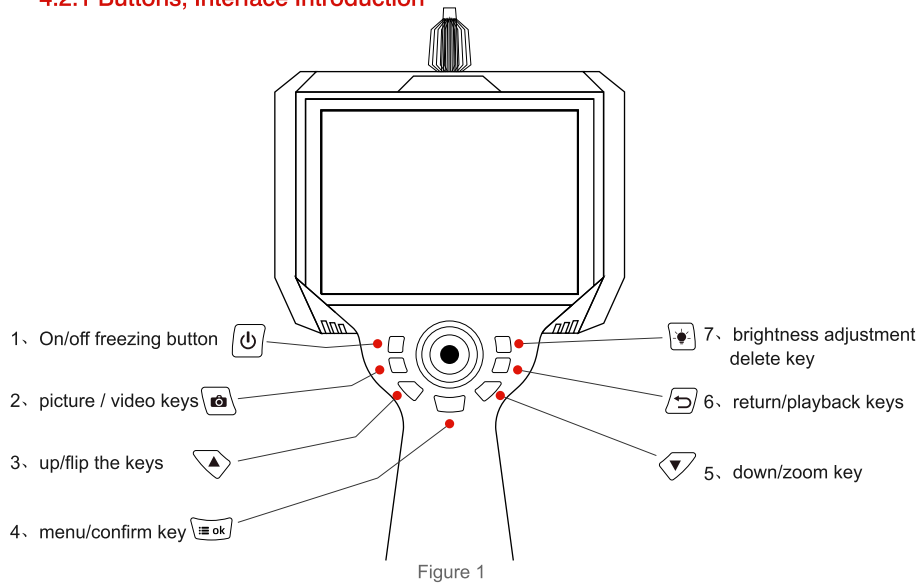

Figure 1

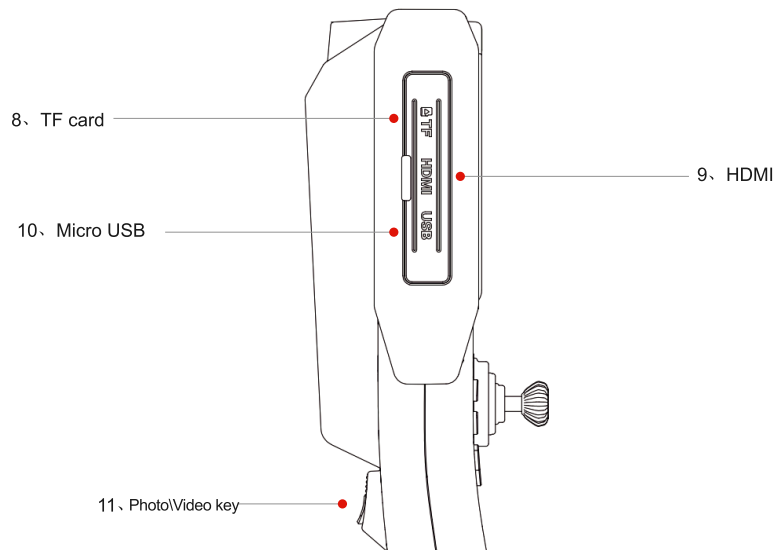

Figure2 Interface diagram

4.2.2 Take off the instrument

- 1 On/off/screen freeze button: power on, power off function, long press power on or off. In the preview state, press as Screen freezing function.
- 2 Photo \ Video button: When the photo icon is displayed in the upper left corner, press the button to take a photo, long time switch to video mode, short Press for video recording; Long press to loop between taking photos and recording.
- 3 Up \ Flip key: it is the function of navigation up when setting the interface; Rotate function when preview interface.
- 4 Menu/Confirm button: press the button to enter the setting interface when previewing the interface; The Confirm button is set on the Settings screen.
- 5 Down/Zoom key: in the preview interface, it acts as a cyclic zoom key; When setting up the interface, go down as a menu navigation.
- 6 Return/playback keys: When previewing the interface, enter the photo and video browsing folder; Go back in the browse screen function.
- 7 Brightness adjustment/delete button: When the system is turned on, the system defaults to an invisible light illumination state and is in an unilluminated state. At this time, the brightness level is 0. Press and hold (≥ 2 seconds) the button, the system enters the visible light illumination state, and the brightness level is 0. Press and hold the button again (≥ 2 seconds), the system returns to the non-illuminated state.
In the state of visible light illumination, successively press the "LED light brightness adjustment" button. The brightness of the LED light increases gradually: 0,1,2...9, after the brightness of the LED light increases to 9, press the button again, the brightness of the LED light becomes 0, and so repeating.
- 8 TF card: external storage use; Maximum support 128GB.
- 9 HDMI: external use of large screen.
- 10 Micro USB: used for data transmission and charging function.
- 11 Photo/Video button: When the small dot icon is displayed in the upper left corner, short press to take a photo, long press for 3 seconds to enter the video recording mode; In video mode, short press to take photo function, long press for 3 seconds to return to video mode and save video files.

4.3 Storage and record files

Method 1: PC directly reads the TF card data. Take out the TF card from the TF card slot of the industrial borescope and insert it into the PC

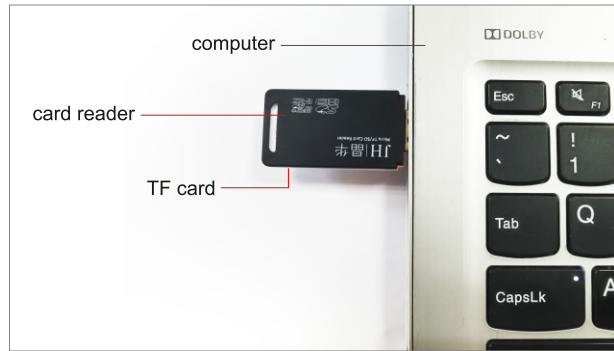

Figure 3

Method 2: Connect directly through the USB data transmission line, and the industrial-borescope enters the USB mode. In USB mode, do not pull out the TF card at will, otherwise it will cause abnormal errors.

As shown in Figure 4

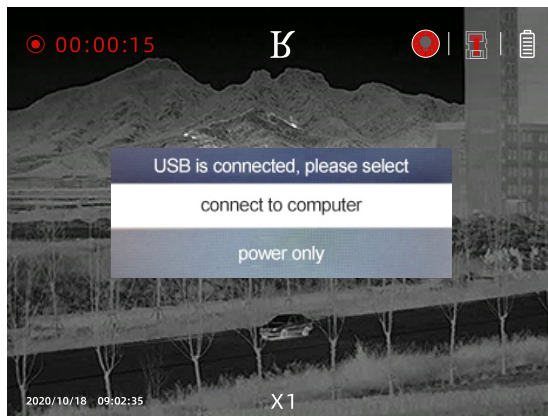

Figure 4

4.4 Scope Work Mode Quick Start Guide

The video observation mirror system mainly has 3 working modes, namely: "real-time preview mode", "photo video browsing mode" mode", and "system setting mode". After booting, it will enter the "real-time preview mode" by default. Each mode and sub-mode Please refer to "Table 1 Button Function List" for details of the button functions in the mode.

Key function list

Key shape	Name	Browsing interface	Browsing	Play video	System setup	Time setup
	Switch image freezes	Shutdown/screen off image freezes	Long press to power off	Long press to power off	Long press to power off	Long press to power off
	Up key rollover key	Image flip	Navigate up	Navigate up	Navigate up	Navigate up
	Down arrow zoom key	Image scaling	Navigate down	Navigate down	Navigate down	Navigate down
	Menu confirmation key	Enter menu	Confirm	Confirm	Confirm	Confirm
	Back/Playback key	Photo video browsing	Return	Return	Return	Return
	Brightness adjustment delete	Bright adjustment	Delete	Delete	\	\
	Photo/Video key	Photo/Video	Return	Return	Return	Return
	Photo/Video key	\	\	\	\	\
	Joystick	Joystick UP:Probe swings up				
		Joystick Down:Probe swings down				
		Joystick Left:Probe swings left				
		Joystick Right:Probe swings right				

4.4.1 Preview interface



Figure 5

4.4.2 Photo/Video

Long press button  to take video and turn off video.

Short press button  to take photo.



Figure 6 Photo Mode



Figure 7 Recording Mode

4.4.3 Photo/Video Browse

Press the key  the preview interface to enter the folder, you can preview photos and play videos online.

See figure 8~9

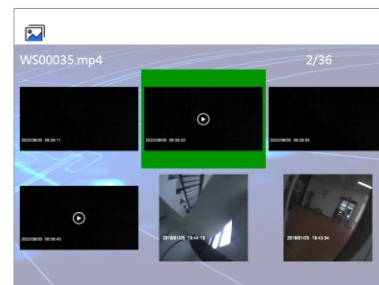



Figure 8 files



Figure 9 video playing

Press the button  to delete a photo or video file, and the delete option can select a single file to delete or delete all of file.

See figure 10

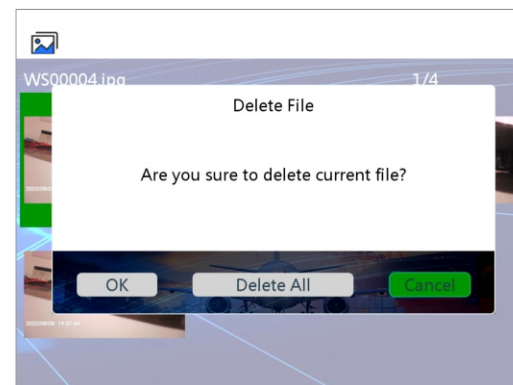

Figure 10 delete option setting

4.4.4 System settings

Press the key "OK" to enter the setting interface.

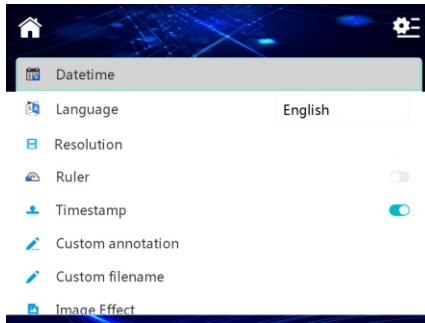

Figure 11 Set interface

4.4.5.1 Date/Time Setting:

In the setting interface, press up or down to enter the date and time setting page.

See figure 12

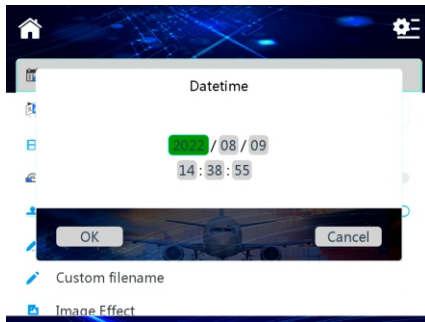

Figure 12 date time setting

Press the key number plus; Press the key to reduce the number, press the key to switch, set up after the completion of the menu Recognize the key to complete the current setting.

4.4.5.2 Language Settings

In the setting interface, press the up or down key to enter the language setting page.

See figure 13

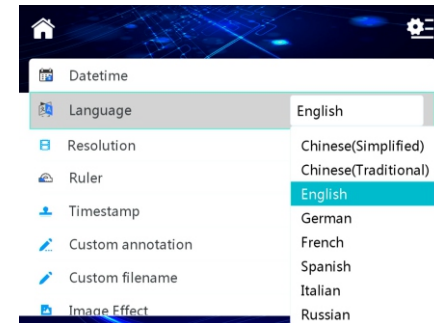

Figure 13 language settings

4.4.5.3 Time /watermark setting

In the setting interface, press the up or down key to enter the time watermark selection function, press the key to switch and confirm.

See figure 14

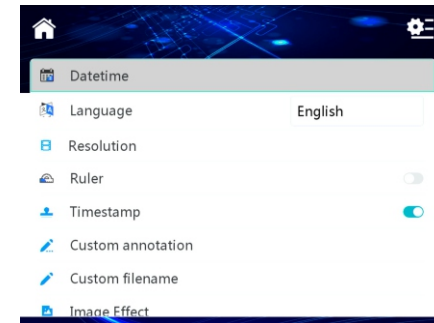

Figure 14 timestamp settings

When the time watermark is turned on, there will be a time watermark at the bottom of the photos and videos taken, and if it is turned off, there will be no time watermark.

See figure 15 16



Figure15. Turn on watermark



Figure16. Turn off watermark

4.4.5.4 Format memory card

Set the interface. Press up or down to enter the formatted memory card page, as shown in Figure 18. Press up Or down to choose whether to format the memory card, press the key to confirm.

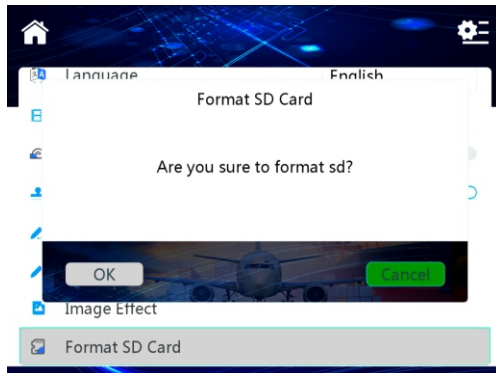

Figure17. Format

4.4.5.5 Custom Annotation

In the setting interface, press up or down to enter the custom annotation interface. Press the up or down key to select the letter to edit the custom annotation, and press the key to confirm.

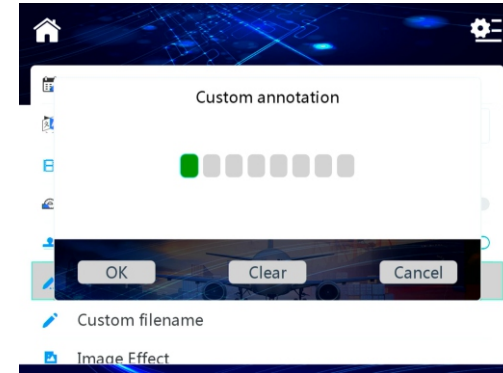

Figure 18 Custom Annotation

4.4.5.6 Image effects

In the setting interface, press the up or down key to enter the image effect interface. Press the up or down key to select the desired image effect, and press the key to confirm.

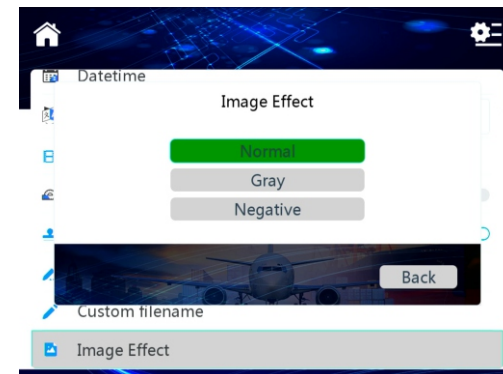

Figure 19 Image effects

4.4.6 File naming:

The naming rule is: custom prefix + serial number

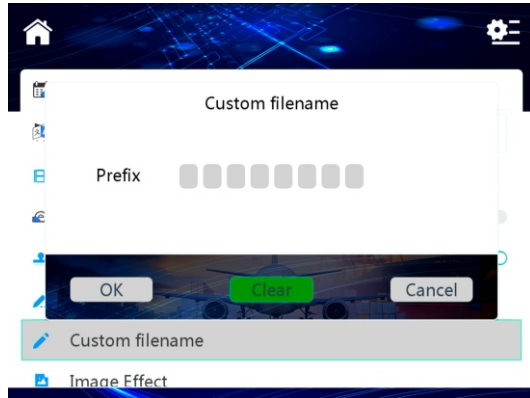

Figure 20 File naming

Note: TF card must be inserted before taking photos/recordings, otherwise the module will not be able to take photos and videos.



4.4.7 Battery status detection

When the sight glass is running, the battery indicator icon on the upper right of the screen displays the real-time battery status (as shown in Figure 21). When the battery is too low to continue working, the battery indicator icon will turn to 0. At this time, the system will issue a low battery alarm and automatically shut down after 30 seconds.



Figure 21

4.4.8 Red/white light switch lighting state

When power on, the system defaults to the invisible light illumination state (red light) and is in the unilluminated state. At this time, the brightness level is 0. Press and hold the button more than 2 seconds , the system enters the visible light illumination state (white light), and the brightness level is 0 at this time. Press and hold the button for more than 2 seconds , the system returns to the invisible light illumination state (red light).



Red light

White light

In the state of invisible light (red light) or visible light (white light), press the button  successively, the LED light brightness gradually increases: 0.1.2.....9, after the LED light brightness increases to 9, press the button, the brightness of the LED light becomes 0, and so on.



Brightness level adjustment

5 . Turn off the instrument

Press the power off button for 3 seconds to complete the shutdown.

6 . Instrument storage mode

- 1. Please use a clean cloth or dry soft towel for cleaning.
- 2. If you do not use it for a long time, please take out the battery.
- 3. It is strictly prohibited to store the instrument in high tempera - ture, bright light, high dust, pollution or corrosive environment.

7 . Troubleshooting

Malfunction	possible reason	Solution
Unable to start	No battery inserted	Charge or install the battery
Cannot adjust brightness	Low battery	Charge or replace the battery
Automatic shut-down	Low battery	Remove battery, reinstall and restart, charge
Image cannot be recorded	Card Capacity is insufficien	Replace cards or delete unwanted pictures

4.4.9 Measurement function

Go to the system settings, turn on the ruler switch, you can turn on the measurement function

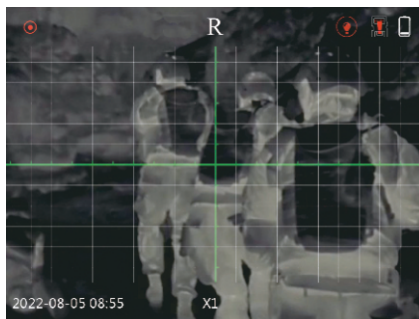
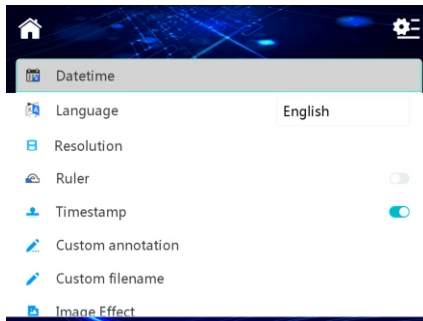

GMGA MEASURING

No. 33 Alley 99/120 Dinh Cong Ha, Dinh Cong Ward, Hoang Mai District, 10000 Hanoi City, Vietnam

Telephone: +84 845 969 336

Email: info@gmga.vn

Website: <https://gmga.vn/>

© 2023 GMGA MEASURING