

Model 831

Technical Reference Manual



Copyright

Copyright 2022, by PCB Piezotronics, Inc. This manual is copyrighted, with all rights reserved. The manual may not be copied in whole or in part for any use without prior written consent of PCB Piezotronics, Inc.

Disclaimer

The following paragraph does not apply in any state or country where such statements are not agreeable with local law:

Even though PCB Piezotronics, Inc. has reviewed its documentation, PCB Piezotronics Inc. makes no warranty or representation, either expressed or implied, with respect to this instrument and documentation, its quality, performance, merchantability, or fitness for a particular purpose. This documentation is subject to change without notice, and should not be construed as a commitment or representation by PCB Piezotronics, Inc.

This publication may contain inaccuracies or typographical errors. PCB Piezotronics, Inc. will periodically update the material for inclusion in new editions. Changes and improvements to the information described in this manual may be made at any time.

Recycling

PCB Piezotronics, Inc. is an environmentally friendly organization and encourages our customers to be environmentally conscious. When this product reaches its end of life, please recycle the product through a local recycling center, or return the product to:



PCB Piezotronics, Inc.
Attn: Recycling Coordinator
1681 West 820 North
Provo, Utah, USA 84601-1341

Warranty

For warranty information, go to www.larsondavis.com → About Us → Limited Product Warranty.



GMGA MEASURING

Address: No. 33 Alley 99/120 Dinh Cong Ha, Dinh Cong Ward, Hoang Mai District, 10000 Hanoi City, Vietnam

Telephone: [+84 845 969 336](tel:+84845969336)

Email: info@gmga.vn

Website: <https://gmga.vn/>

Table of Contents

Chapter 1	831 Features	1-1
	Hardware Features	1-1
	Basic Measurements	1-2
	Basic Operation	1-2
	Available Options	1-3
	Standard Accessories	1-4
	Optional Accessories	1-5
Chapter 2	First Use	2-1
	Unpacking and Inspection	2-1
	Connecting the Microphone and Preamplifier	2-2
	Connecting the Preamplifier	2-3
	Disconnecting the Preamplifier	2-4
	Powering the Model 831	2-4
Chapter 3	Overview	3-1
	831 Components	3-1
	Summary of Displays and Icons	3-7
	Navigating and Selecting	3-12
	Basic Run Functions	3-12
	Tab and Setting Displays	3-13
	Parameter Selection	3-20
Chapter 4	Basic Measurement Setup	4-1
	Settings Screen	4-1
	Setup Tabs	4-2
	Exiting Settings Screen	4-15
	Setup Manager	4-16
Chapter 5	Data Display	5-1
	Data Labels	5-1
	Tabbed Structure	5-1
	Live Tab	5-2
	Overall Tab	5-12
	Session Log Tab	5-25
	Adjust Graph Scale	5-29
	View Spectrum Normalized	5-30

	Any Level Display	5-41
Chapter 6	Run Control	6-1
	Run Control Setup	6-1
	Run Mode with Measurement History	6-3
	Run Modes Without Measurement History	6-4
Chapter 7	Making a Measurement	7-1
	Configuration of the System	7-1
	Switching On the Model 831	7-1
	Model 831 Setup	7-3
	Calibrating the Model 831	7-3
	Positioning the Model 831	7-3
	Performing the Measurement	7-5
	Storing the Measurement	7-15
	Recovery After Improper Shutdown	7-18
Chapter 8	Calibration	8-1
	Calibration Overview	8-1
	Control Panel - Calibrate	8-2
	Acoustic Calibration	8-5
	Sensitivity Tab	8-13
	Calibration Without Preamplifier	8-15
	Certification	8-16
	E.A. Check	8-18
	E.A. History	8-20
Chapter 9	Industrial Hygiene	9-1
	Measurement Setup	9-1
	Data Display	9-5
Chapter 10	Voice Recording	10-1
	Control Panel - Voice Recording	10-1
	Voice Recorder	10-2
Chapter 11	Time History	11-1
	Metrics Logged	11-1
	Time History Setup	11-4
	Time History Display	11-9
	Locate Record Number	11-16

	Link to Measurement History Display	11-17
	Markers	11-18
Chapter 12	Measurement History	12-1
	Run Control with Measurement History	12-1
	Continuous and Timer Modes	12-2
	Timed Stop Mode	12-3
	Manual and Stop When Stable Modes	12-5
	Display of Measurement History Data	12-5
	Storing a Measurement History	12-11
	Link to Time History	12-11
Chapter 13	Event History	13-1
	Level Based Events	13-1
	Event History Setup	13-2
	Trigger Method	13-3
	Event Time History Setup	13-10
	Event History Display	13-12
	Link to Time History and Measurement History	13-22
Chapter 14	FFT and Tonality	14-1
	Accessing FFT Mode	14-1
	Configuring a Measurement	14-3
	Viewing and Analyzing Results	14-10
	Storing Data	14-21
	Viewing Stored Data	14-21
	Return to Sound Level Meter Mode	14-22
Chapter 15	RT-60	15-1
	Accessing RT-60 Mode	15-1
	Making a Measurement	15-3
	Viewing and Analyzing Results	15-8
	Manually Controlling the Internal Noise Source	15-16
	Customizing Measurements	15-20
	Storing Data	15-26
	Viewing Stored Data	15-26
	Quality Indicators	15-27
	Accuracy Grade	15-28
	Return to Sound Level Meter Mode	15-29

Chapter 16	Sound Recording	16-1
	Sound Recording Types	16-1
	Sound Recording Setup	16-2
	Manual Sound Recording	16-7
	Marker Initiated Recording	16-9
	Event Sound Recording	16-14
	Measurement History Sound Recording	16-18
	Combined Sound Recordings	16-19
	Sound Recording Playback	16-20
Chapter 17	Data Explorer	17-1
	Control Panel - Data Explorer	17-1
	Data Explorer	17-2
Chapter 18	System Properties	18-1
	Control Panel - System Properties	18-1
	Device	18-2
	Time	18-3
	Power	18-5
	Preferences	18-10
	Localization	18-20
	Displays	18-23
	Options	18-29
	Logic I/O	18-31
Chapter 19	Non-Acoustical Inputs	19-1
	831-INT	19-1
	Weather Measurement Using 831-INT	19-2
	Location Measurement Using 831-INT	19-10
Chapter 20	Communication	20-1
	Control Panel - Communication	20-1
	Modem Tab	20-3
	Wireless Tab	20-6
	RS-232 Tab	20-8
	SMS Out	20-12
	Network Tab	20-13
	Status Tab	20-15
	Troubleshooting	20-20

Chapter 21	Lock/Unlock the Model 831	21-1
	Control Panel - Lock	21-1
	Fully Locked	21-5
	Locked With Auto-Store	21-6
	Locked With Manual-Store	21-7
	Calibration When The Model 831 Is Locked	21-8
Chapter 22	About	22-1
	Control Panel - About	22-1
	About	22-1
	Standards	22-2
	Options	22-3
	User	22-4
Chapter 23	System Utilities	23-1
	Control Panel - System Utilities	23-1
	File System	23-2
Chapter 24	Parameters Measured	24-1
	Basic Sound Level Measurements	24-1
	Sound Exposure Metrics Measured	24-3
	Statistical Metrics Measured	24-4
	Exceedance Counters	24-6
	Miscellaneous Parameters	24-6
	Time History (831-LOG Required)	24-6
	Measurement History (831-ELA Required)	24-6
	Event History (831-ELA Required)	24-6
Chapter 25	Memory Utilization	25-1
	Out Of Memory Stop	25-1
	Overall Data	25-1
	Session Log	25-1
	Measurement History	25-2
	Time History	25-2
	Events	25-2
	Voice Messages	25-3
	Sound Recording	25-3
	Bad Flash Blocks	25-4

Chapter 26	Upgrade Firmware and Options	26-1
	G4 LD Utility	26-1
	Upgrading Model 831 Firmware	26-2
	Upgrading Options	26-5
Appendix A	Technical Specifications	
	Standards Met by Model 831	A-1
	Model 831 Specifications	A-2
	CE Information	A-18
	1/1 and 1/3 Octave Filters	A-19
	Position of Instrument and Operator	A-29
	Frequency Response Charts	A-31
	Vibration Sensitivity	A-52
Appendix B	Measuring to IEC61672-1	B-1
	Sections 5, 6, 7 and 9 (except 9.3)	B-1
Appendix C	Integrated Level Calculations	C-1
	Basic Integrated Level Calculations	C-1
	Community Noise Descriptors	C-9
Appendix D	Glossary	D-1

831 Features

Welcome to the Larson Davis Model 831. This versatile instrument, with graphic display, performs the functions of several instruments; It puts the combined features of a precision sound level meter and a real-time frequency analyzer in the palm of your hand.

Hardware Features

The Larson Davis Model 831 has the following features:

- **Precision integrating sound level meter**
- **2 GB data storage**
- **160 X 240 graphic LCD display with backlight and icon-driven user interface**
- **Quiet Touch elastomeric keypad**
- **Large dynamic range > 120 dBA**
- **RMS Detectors: Slow, Fast & Impulse**
- **RMS Frequency Weighting: A, C & Z**
- **Peak Frequency Weighting: A, C & Z**
- **Any Level™: Simultaneous measurement and display of Max and Min sound pressure levels (Slow, Fast and Impulse detectors), plus Leq and Peak levels, all with A, C and Z frequency weighting**
- **Weather Measurements (Wind Speed and Direction, Temperature and Humidity)**
- **Jack for AC/DC output or headset microphone and speaker**
- **Compatible with 61 m (200 ft.) microphone extension cable (full scale to 20 kHz)**
- **4-AA batteries provide upwards 8 hour operating time**
- **Dust tight (IP53) durable plastic case with tripod mount (tripod not included) and lanyard**

- **USB 2.0 full speed host connector for mass storage, cellular and dial-up modems and future devices**
- **USB 2.0 full speed peripheral connector for control and data download by a PC**
- **AUX control connector for USB remote power, weather transducers and the 831-INT**
- **I/O connector for communicating with peripheral devices such as weather transducers**
- **Multiple language support: English, French, Italian, German, Spanish and Russian**
- **Field-upgradeable firmware**

Basic Measurements

- **SPL, Leq, Lmax, Lmin, Lpeak, Lpeak(max)**
- **2 RMS event counters and 3 Peak event counters**
- **L_N statistics: computed to 0.01% with 0.1 dB accuracy over the range $L_{0.01}$ through $L_{99.99}$, with display of six on the meter, and Histogram tables**

Basic Operation

- **Status Bar and About display**
- **Auto-Store with Auto-Reset**
- **Run Timer and Stop-When-Stable Control**
- **Back-erase**
- **Markers to annotate portions of time histories**
- **Real-time clock**
- **Start time, elapsed time and paused time**
- **Time stamping for Lmax, Lmin, Lpeak(max) metrics**
- **Session Log**
- **Lock functions**
- **Calibration with calibration history and list of calibrators**
- **Power management**
- **Status bar and About display**
- **Names Setup files and Setup Manager**

- **Data files and Data Explorer**
- **Automatic data backup to prevent data loss on power failure**
- **Overall measurement**
- **Community Noise Measurement**
- **Voice Annotation**
- **GPS Data**

Available Options

The Model 831 is delivered with all firmware options available at the time of manufacture already installed. However, only the options you purchase are enabled. Additional firmware options can be enabled at any time. Contact Technical Support or your authorized representative for more information.

Purchase Required Options

- **Real-time 1/1 & 1/3 Octave Frequency Analysis (831-OB3)**
- **Measurement History for the manual or timed storage of statistical data (831-ELA)**
- **Automatic Data Logging with periods from 20 ms to 24 hour (831-LOG)**
- **Fast Spectral Time History Data Logging with intervals of 2.5, 5.0 or 10 ms (831-FST, requires 831-LOG and 831-OB3)**
- **Exceedance-based Logging Analysis with Events (831-ELA). Automatic sound recordings can also be made when the 831-SR option is also enabled**
- **Industrial Hygiene Measurement (831-IH)**
- **Sound Recording (831-SR)**
- **Advanced IP Communication for Cellular connectivity (831-COMM)**
- **RT60 (831-RT): Instrument mode for measuring reverberation time**
- **FFT (831-FFT): FFT Instrument mode**

No Charge Options

The following options are available with the Model 831 base package:

- **Weather Data: Wind Speed and Direction, Temperature, Humidity (831-WTHR)**
- **Analog Modem or RS-232 Communication (831-MDM)**

Standard Accessories

Some of these options may not be provided with systems designed for specific applications.

The Model 831 is generally delivered with the standard accessories described below.

Microphone Preamplifier

- **PRM831 (16 to 140 dB measurement range)**
- **PRM2103 (16 to 140 dB measurement range)**

Microphone

- **377B02 1/2" free-field pre-polarized microphone, 50 mV/Pa, providing performance conforming to Class 1 sound level meter standards**

or

- **377C20 1/2" random incidence pre-polarized microphone, 50 mV/Pa, providing performance conforming to Class 1 sound level meter standards**

Software CD

- **G4 LD Utility Software for setup, measurement, download, and data viewing through CBL138 USB, TCP/IP, serial, or analog modem connections**
- **SLM Utility-G3 software for setup, control and high speed data download, for which a CBL138 USB cable is required to utilize the software**

Accessory Kit

Included with purchase of 831-FF or 831-RI; not included when Model 831 is purchased without microphone and preamplifier.

831-ACC including:

- **831-CCS Hard Shell Case**
- **PSA029 Universal AC Power Adaptor, providing power from PC via USB port**

- CBL138 USB to mini-B cable, 1.8 m
- WS001 3 1/2" Windscreen
- 4 Rechargeable AA NiMH batteries

Other

- Lanyard

Optional Accessories

Microphones

- 1/2" free-field pre-polarized microphone, 50 mV/Pa
- 1/2" random incidence pre-polarized microphone, 50 mV/Pa
- 1/4" free-field pre-polarized microphone, 4 mV/Pa, for higher level and/or higher frequency measurements (ADP043 adaptor required)
- 1/4" pressure pre-polarized microphone, 1.6 mV/Pa, for higher level and/or higher frequency measurements (ADP043 adaptor required)

Microphone Preamplifiers

- 1/2" ICP Low Noise Microphone Preamplifier (requires adaptor ADP074)
- PRM2103 Outdoor Microphone Preamplifier
- PRM426A12 Outdoor Microphone Preamplifier
- 426A12-NPT Coupler, 1.5"X27"ISO228-1 to NPT thread

Environmental Protection

- EPS2116 Environmental Shell, protects microphone and preamplifier from rain and wind with mounting options for pipes, poles, and most tripods
- EPS2106-2 Environmental Shell, protects microphone and preamplifier from rain and wind and used with tripod TRP003
- EPS2108-2 Environmental Shell, protects microphone and preamplifier from rain and wind and used with tripod TRP002
- EPS029-831 Weather-proof enclosure for remote noise monitoring; includes two batteries and microphone mast

- **EPS030-831 Weather-proof enclosure for remote noise monitoring; includes battery**
- **EPS031 Pole mount weather proof fiberglass enclosure for AC power and mounting to TRO019-XX and TRP020-XX series tripods; includes enclosure, internal brackets and 9-AH backup battery**
- **EPS032 Pole mount weather proof fiberglass enclosure for solar power and mounting to TRP019-XX and TRP020-XX series tripods; includes enclosure, internal brackets and solar charger**
- **EPS033 Steel security band for NMS systems**
- **NMS016 Permanent noise monitoring system with weather proof enclosure and tilt down pole designed for AC power; includes Model 831, EPS031, 831-INT, 17' pole, 426A12, 9-AH backup battery and fiberglass enclosure**
- **NMS017 Permanent noise monitoring system with weather proof enclosure and tilt down pole designed for solar power.; includes Model 831, EPS032, 831-INT, 17' pole, 425A12, solar charger and fiberglass enclosure, with the following optional solar accessories available:**
 - **PSA012-80 80W SOLAR PANEL**
 - **PSA012-50 50W SOLAR PANEL**
 - **BAT012 100AH BATTERY**
- **NMS018 Portable Noise monitoring system with weather proof enclosure and tripod designed for AC power; includes Model 831, EPS031, 831-INT, heavy duty tripod (10', 15' and 20' configurable heights), 426A12, 9-AH back up battery and fiberglass enclosure**
- **NMS019 Permanent noise monitoring system with weather proof enclosure and tripod system designed for solar power; includes Model 831, EPS032, 831-INT, heavy duty tripod (10', 15' and 20' configurable heights), 426A12, solar charger and fiberglass enclosure, with the following optional solar accessories available:**
 - **PSA012-80 80W Solar Panel**
 - **PSA012-50 50W Solar Panel**

- BAT012 100AH Battery**
- BAT013 2X21AH batteries**

Weather Data Acquisition

The SEN028, SEN029, and SEN030 are no longer supported.

- **831-INT 831 Interface Unit for use with 426A12 Outdoor Microphone Preamplifier and weather sensors**
- **SEN028 Wind Monitor; Speed and Direction**
- **SEN029 Anemometer; Speed and Direction (Low Cost)**
- **SEN030 Sensor; Temperature and Humidity**
- **SEN031 Sensor; Weather Station**

Communication DVX008A

- **MDMUSB-A Modem V.90 Dial-up with USB Interface**
- **MDMUSB-E Modem Edge USB Wireless Quad-Band GSM**
- **DVX008A USB to RS232, 9 Pin Adaptor**
- **CBL117 Serial Null Modem Cable, Connects DVX008A to PC Serial Port**
- **831-INT-ET 831-INT with integrated Ethernet capability**

GPS

- **GPS001 GPS Receiver, USB Magnetic Mount**

Equivalent Electrical Impedance Adaptor

An equivalent electrical impedance adaptor can be used in place of the microphone when very high impedance measurements need to be made and the instrument is being tested electrically. The adaptor is simply a series capacitor with the same capacitance as the microphone it is replacing. The following adaptors will be available for sale. If square wave pulse measurement is to be performed, then the adaptor must also be used with a 100 kHz, low pass, T filter.

- **ADP002 6.8pF BNC Input Adaptor for 1/4 in., 7pF microphone equivalent**
- **ADP090 12pF BNC Input Adaptor for 1/2 in., 12pF microphone equivalent**
- **ADP092 BNC In-Line Low Pass Filter 75kHz**

Cables

Direct Input Cable or Adaptor

- **Microphone Extension Cable: EXCXXX (shielded), where XXX is the length in feet (XXX = 010, 020, 050, 100 and 200 available)**
- **CBL138 USB Cable**
- **CBL139 AC/DC Output Cable**

Cables for Environmental Monitoring

- **CBL152 Cable; 426A12 to 831 Signal, 20'**
- **CBL153 Cable; 426A12 to 831-INT Control, 20'**
- **CBL154 Cable; 426A12 to Model 831 Control, 20'**
- **CBL144 Cable; PRM2100 to 831 Signal, 20'**
- **CBL145 Cable; PRM2100 to 831 Control, 20'**
- **CBL146 Cable; PRM2100 to 831-INT Control, 20'**
- **CBL203 Cable; PRM2103 to 831Control, 20'**
- **CBL208 Cable; PRM2103 to 831-INT Control, 20'**

Cable for use with PSA027 Universal Input Power Supply AC Power Adaptor

- **CBL140 Cable; 831 Power, 2.5 mm JACK, 1'**

Power Supply

- **PSA027 Universal 90-240 AC Power Adaptor providing power from electrical outlet, used to power the Model 831 in conjunction with CBL140, CBL145 or CBL154. 1.25 A, 2.5X5.5X14 mm**
- **BAT015 External battery powering device for the 831, holding 4 or 8 D-sized alkaline 1.5 volt batteries to extend run time**

Tripods

- **TRP001 Instrument/Camera Tripod with ADP032 1/2 in. microphone clip and used with EPS2108-2**
- **TRP002 Microphone Stand with Boom**
- **TRP003 Support Tripod, heavy duty, can be used with EPS029, EPS030 and EPS2106-2**
- **ADP034 Mounting adapter to attach EPS2106-2 to TRP003**
- **ADP091 Mounting adapter, 426A12 TO TRP003**
- **TRP019 Permanent 17' tilt down pole. Use with EPS031 AND EPS032**

The TRP020-06 tripod is not for use with EPS031 AND EPS032.

- **TRP020-06 Heavy duty 6' tripod. Use with 426A12, EPS030-831 AND EPS029-831**
- **TRP020-10 Heavy duty 10' tripod. Use with 426A12, EPS030-831, EPS029-831, EPS031 and EPS032**
- **TRP020-15 Heavy duty 15' tripod. Use with 426A12, EPS030-831, EPS029-831, EPS031 and EPS032**
- **TRP020-20 Heavy duty 20' tripod. Use with 426A12, EPS030-831, EPS029-831, EPS031 and EPS032**

Other Hardware

- **ACC003 Headset with microphone for voice recording/playback**

Calibrators

- **CAL200 Class 1 Sound Level Calibrator, 94/114 dB @ 1 kHz**
- **CAL250 Class 1 Sound Level Calibrator, 114 dB @ 250 Hz**

Soft Case

- **CCS032 pouch with belt clip**

Software

- **DNA (Data Navigation and Analysis) software provides setup and remote operation of the Model 831, providing real-time data displays on a PC. Powerful graphics routines are provided to create custom data displays ranging from simple time histories and frequency spectra to spectrograms (level vs frequency vs time) and annotated data presentations. A variety of advanced post-processing tools can be used to extend measured data to engineering results such as searching time history data for user-defined events, masking or modifying portions of measured data and recalculating Leq and searching spectra for pure tones. DNA will take you from measured data to a completed project, including report generation.**

First Use

This chapter outlines the steps to unpack the Model 831 and prepare it for first use. The following topics are covered:

- **Unpacking and Inspection**
- **Connecting the microphone and preamplifier**
- **Installing 4 AA batteries**
- **Using USB power**
- **Powering-up the Model 831**

You will then be ready to use the Model 831 for actual measurements.

Unpacking and Inspection

Your Model 831 has been shipped in protective packaging. Please verify that the package contains the items listed below. Retain the packaging for safe shipment for calibration service. Report any damage or shortage immediately to PCB Piezotronics, Inc. at (888) 258-3222 (toll free) or +1 716- 926-8243.

- **Model 831**
- **PRM831 Microphone Preamplifier**
- **Microphone**
- **831-ACC including**
 - **831-CCS Hard Shell Case**
 - **PSA029 Universal AC Power Adapter**
 - **WS001 3 1/2" Windscreen**
- **Lanyard**
- **4 - AA NiMH batteries**

*Included with 831-FF and 831-RI.
Not included when 831 is purchased
without preamplifier and
microphone.*

If you have not already done so, please record the purchase date, the model and serial numbers for your instrument, preamplifier and microphone. You will find the instrument's Model and Serial numbers printed on the label on the instrument's back panel. The microphone model and serial numbers are engraved on the outside of the microphone as shown in FIGURE 2-1 "Microphone". The preamplifier

model and serial numbers are engraved on the outside surface of the preamplifier. You may be asked to provide this information during any future communications with PCB Piezotronics, Inc.



FIGURE 2-1 Microphone

Connecting the Microphone and Preamplifier

The bottom end of the microphone attaches to the top end of the preamplifier. The top end of the preamplifier has a single gold pin and threads on the preamplifier body. The model and serial number of the microphone are engraved on the side.



FIGURE 2-2 Microphone-Preamplifier

Carefully place the bottom end of the microphone over the top end of the preamplifier and gently screw the assembly together. The microphone body will seat smoothly against the preamplifier body. **DO NOT** use excessive force.

When removing the microphone, turn while gripping the microphone body, not the grid cap, to prevent damage to the microphone diaphragm.

Connecting the Preamplifier

Caution: Do not attempt to unscrew the collar/ring at the top of the Model 831 body.

The bottom end of the preamplifier has a 5 pin connector that fits snugly into the top of the Model 831. Insert the preamplifier into the mating connector on the Model 831. The connectors are keyed for correct alignment; there is a laser engraved line on the preamplifier which aligns with the arrow on the Model 831. Rotate the preamplifier until the keyways line up. Press the assemblies together until a small click is heard. The microphone / preamplifier assembly is now securely attached to the Model 831.

If the Model 831 is ON when the preamplifier is connected to the Model 831, the Preamp Connected message box will appear for several seconds.



FIGURE 2-3 Preamplifier Connected

Press **ENTER** to clear the message box.

Disconnecting the Preamp

On the front surface of the Model 831, just below the preamplifier connector, is a small button. Press and hold this button while pulling the microphone / preamplifier assembly out of the Model 831.



FIGURE 2-4 Push Button to Release Preamp

If the Model 831 is ON when the preamp is disconnected, the Preamp Disconnected message box will appear for several seconds.



FIGURE 2-5 Disconnect The Preamp

Press **ENTER** clear the message box.

Powering the Model 831

The following section provides power information for the model 831, including the following:

- **Battery Power**
- **External Power Supply**
- **Power Up Operation**
- **Power Control Page**
- **Hardware Power Switch**

Battery Power

The Model 831 is compatible with AA nickel metal hydride (NiMH), Alkaline or 1.5 Volt Lithium batteries. Energizer, Duracell and other nationally recognized brands are the preferred suppliers of alkaline batteries. These will provide the user with the best battery life estimation. Sanyo, Energizer and Ray-O-Vac, 2500 mAH, Lithium, AA, NiMH batteries and their respective fast chargers are also recommended.

WARNING: Do not mix Alkaline and NiMH batteries.

WARNING: Do not mix batteries from different manufacturers

WARNING: Replace all four batteries when installing fresh cells

WARNING: The correct battery type must be specified, as described in "Battery Type" on page 18-5, based on the battery type installed. Otherwise, serious damage, injury or fire can occur when the battery type is set to NiMH but Alkaline or Lithium batteries are installed because the internal charger will be enabled. Alkaline or Lithium batteries must not be charged.

Battery Voltage and Estimated Run Time are displayed on the Power Control screen and the last page of the **Live** tab. The battery icon indicates the state of the battery charge by the width of the interior shaded portion. Figure 2-6 shows a fully charged battery and a nearly discharged battery.

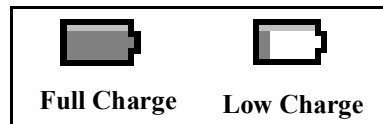

FIGURE 2-6 Battery Status Icons

A battery icon is always available in the status bar at the top of the screen. The battery voltage and the state of the battery

icon directly reflect the remaining Estimated Run Time as displayed by the instrument.

Low Battery

As the battery nears end-of-life (1% of capacity), the empty battery symbol will begin to flash. The unit will shut down in a short time because the battery voltage is too low.

When the battery is at the end-of-life, the Model 831 will stop running, save all data and instrument status, then turn off. When the unit is turned on again, with fresh batteries or an external power supply, the unit returns to the state it was in when it shut down.

If external power is supplied through the USB connector, the battery icon is replaced with the External Power icon, as shown in Figure 2-7.



FIGURE 2-7 External Power Icon

When external power is connected to the Model 831, the unit is not dependent on batteries. The Estimated Run Time calculation is valid only if there is no external power.

Inserting Batteries

There are 2 tabs on the bottom of the battery door that engage the case of the Model 831.

The battery compartment of the Model 831 is located on the back of the unit. There is a clip on the battery door. To remove the battery door, place a finger on the clip and push it downward towards the battery door while pulling away from the body of the instrument. The battery door will pivot away from the unit.

Insert 4 fresh AA batteries as shown in FIGURE 2-8. Ensure correct alignment of the batteries + and - terminals as indicated by diagrams on the bottom of the battery compartment.



FIGURE 2-8 Insert Batteries

After the batteries are installed, insert the two tabs on the bottom edge of the battery door into the mating slots in the case. Close the battery door, allowing the clip to snap in place on the case.

Selecting Battery Type

The battery type is selected from the **Power** tab in System Properties, as described in the section “Battery Type” on page 18-5.

Charging Batteries On-board

When using NiMH batteries and powering the Model 831 from either the computer (via USB port) or from the PSA029 power supply, or from another external source, the batteries will be charged inside the instrument. The charge time to completely recharge the cells is about sixteen hours when the instrument is powered off. The batteries will be charged while the instrument is powered on at a reduced rate as long as the backlight and USB Host features are off.

Charge Status LED

The charge status is indicated by an LED beneath the power key as follows:

- **LED continuously lit: Charging**
- **LED not lit: Not charging**
- **LED flashing at 1/sec: Trickle charging.** This is typically done early in the charging cycle when the battery is cold, or when the battery has been highly discharged. The charge rate should increase when these conditions improve.

External Power Supply

The Model 831 can be powered from a variety of sources including internal batteries, via the USB port from a computer, via the USB port from the PSA029 power supply, via the I/O port from the PSA027 power supply (using CBL140 or CBL154), from an external +10.8 to +30 Volt battery, or from an external +10.8 to +30 Volt mains power source.

USB Port Power

When powering the Model 831 by external power, Larson Davis recommends the Model 831-INT System Interface Unit and the appropriate Larson-Davis cable for making the connection to the battery or batteries.

When powered via the USB port by a computer, use of the computer's USB power is negotiated with the host and cannot be utilized until permission is granted by the host. This means that the Model 831 must run on batteries until allowed by the host to run on USB or external power. If the batteries cannot provide sufficient power (flat cells) the Model 831 may not power on. Ensure that the Model 831 has good batteries in order to turn on. If there are no batteries installed in the instrument, it will use USB power regardless of negotiation.

The PSA029 is supplied with power plug adaptors for most areas of the world.

The Model 831 can be powered via the USB port with the PSA029 external power supply. The PSA029 has an input operating voltage range of 90 to 274 VAC and a power line frequency range of 47 to 63 Hz. The output voltage from the supply is 5 VDC. The PSA029 used a standard USB A to Mini-B 5-pin cable which connects to the USB connector on the bottom of the Model 831.

If the Model 831 is operated without batteries installed and power is interrupted, data may be lost.

With the PSA029 power supply connected and operating at rated conditions, the Model 831 will operate properly with or without batteries installed.

Low Voltage Shutdown

The Model 831 has a special feature to preserve the service life of an external SLA (Sealed Lead-Acid) battery by preventing it from being discharged excessively. When the battery voltage drops below the external shutoff voltage (default value +10.8 volts), but remains above +10.2 volts for one minute, the instrument will stop, save data and turn the Model 831 off.

Power Outage

In the event of power outage, unattended Model 831 meters with serial numbers greater than 2089 will turn on automatically in six hours as a recovery mechanism.

Sudden Loss of External Voltage

WARNING!

A sudden loss of power while the Model 831 is storing data may lead to hardware damage and should be avoided. To avoid this, turn off the Model 831 prior to turning off the PC, or before unplugging USB cables from the PC.

If the external voltage is suddenly lost, for example when the external supply is disconnected or when mains power fails and there is no external battery, the Model 831 will continue to run on internal batteries if they are present and in good condition. Without internal batteries, the Model 831 will shut-down and un-stored data may be lost.

Power-Up Operation

The Model 831 automatically detects its power source while it is turning on and does not fully start if a problem is found.

Insufficient Battery Voltage

If the internal battery is powering the instrument, i.e. there is not USB or external power, and is less than ~4.2 Volts, the display shown in FIGURE 2-9 appears with the gray box inside

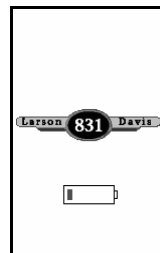

FIGURE 2-9 Insufficient Battery Voltage

Insufficient External Voltage

If the external power source is operating the instrument, i.e. there is no USB or internal battery power available, and is less than about 10.8 Volts, the display shown in FIGURE 2-10 appears with the gray box inside the battery symbol flashing on and off every second.

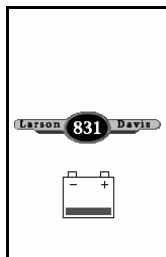



FIGURE 2-10 Insufficient External Voltage

If the power fault condition is not alleviated within 2 minutes, the instrument powers off. If a sufficient power supply is provided for more than 10 seconds, i.e. USB or Main power is connected, the instrument proceeds to turn on.

Power Control Page

The estimated battery run time is only shown after running on batteries for more than one minute, which permits the battery voltage to stabilize.

If the Model 831 is ON, pressing the  (ON/OFF) key displays the Power Control screen.

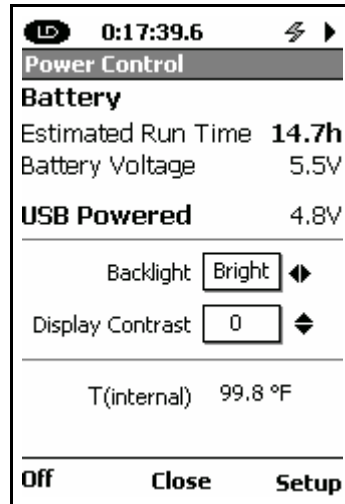









FIGURE 2-11 Power Control View

Located on the first section of this screen is the **Estimated Battery Run Time** (calculated using the voltage of the installed batteries), **Battery Voltage** and the **USB Powered** voltage.

For more information on Backlight and Display Contrast, see the "Backlight" on page 18-9 and "Display Contrast" on page 18-9.

Next, **Backlight** and **Display Contrast** are adjusted using the , ,  and  keys. **Backlight** provides three options: **Off**, **Dim** and **Bright**, which are adjusted using the  and  keys. The Display Contrast has a range of -9 to 9, which is adjusted using the  and  keys.

The units of the temperature display are user-selectable, as described in "Units" on page 18-22.

The last section displays the Model 831 internal temperature that is used to automatically adjust the contrast of the display to compensate for temperature changes.

Hardware Power Switch

DO NOT use the hardware power switch to turn the Model 831 OFF. This may cause data to be lost and permanent damage may occur. Press the  key for several seconds to turn off the meter.

The Hardware Power Switch on the bottom of the Model 831 disconnects the batteries from the Model 831 hardware. The real-time clock will maintain its value for six minutes, enough to implement a battery change. This prevents battery drain when the Model 831 is not in use for an extended period of time (≥ 2 weeks). If the Hardware Power Switch is in the "0" position, the batteries are disconnected.

After installing batteries be sure to move the switch to the "|" position. This applies power to all of the Model 831 hardware.

The Hardware Power Switch should not be used to turn the Model 831 ON and OFF. If the Hardware Power Switch is used to turn the Model 831 OFF, data may be lost.

Overview

This chapter provides an overview of the components, displays, and functions of the 831 sound level meter.

831 Components



FIGURE 3-1 The Model 831

The standard Model 831 shown in FIGURE 3-1 includes the following:

- 1/2 in. diameter condenser microphone
- PRM831 microphone preamplifier
- Backlit graphic 160 x 240 pixel LCD display
- 13-key soft rubber backlit keypad

- AC/DC output, control, USB, and external power connectors (shown in FIGURE 3-2)
- True “hand held” instrument with “sure grip” pads

FIGURE 3-2 shows the bottom view of the Model 831.

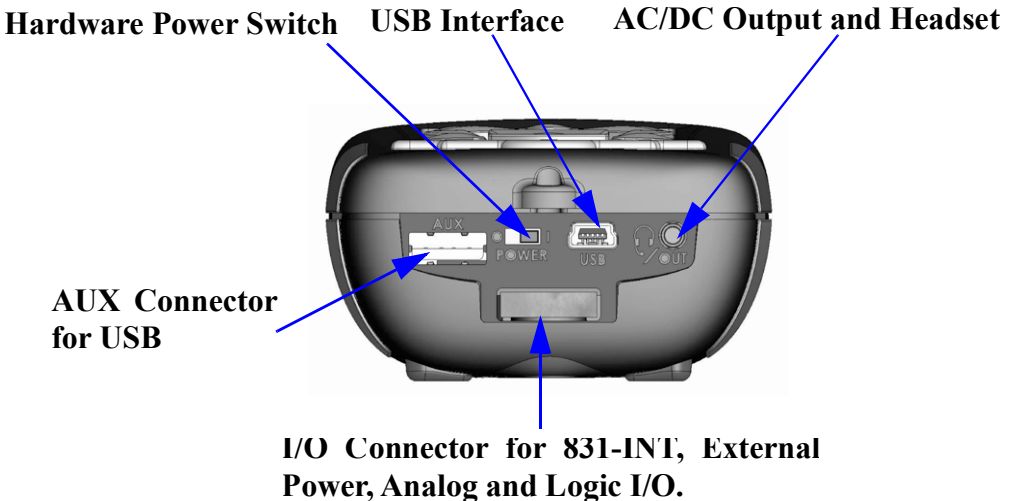

FIGURE 3-2 Model 831 Bottom View

DO NOT use the hardware power switch to turn the Model 831 ON or OFF. This will cause data to be lost. The purpose of this switch is to disconnect the batteries for storage (1 to 2 weeks). It is recommended that the batteries be removed from the instrument if it will not be used for a month or longer (the batteries may self-discharge and leak, damaging the instrument).

- **Hardware Power Switch:** When set to “O”, completely powers down the Model 831 for storage. However, the real-time clock will maintain its value for six minutes, long enough to complete a battery change. Set to “|” for instrument operation.
- **USB Interface:** USB 2.0 peripheral full-speed port used for communication with a PC, control of the Model 831 from the PC and downloading of data from the Model 831 to the PC. The PSA029 external power supply may be connected here. The maximum USB cable length is 5 m and the cable is part number CBL138.
- **AC/DC Output and Headset Jack:** used to output analog AC and DC signals or to connect to a headset for the recording and playback of voice records.
- **AUX Connector for USB:** intended for use with USB mass storage, cellular & dial-up modems, GPS and future devices.

- **I/O Connector for Peripherals and External Power:** typically used with external devices. For more information, see “I/O Connector Specification” on page A-8:
 - **CBL143 and CBL151 cables:** these cables permit the Model 831 to be powered from external 12 V batteries
 - **CBL154 cable:** used to obtain power from a battery when used with the 426A12
 - **831-INT:** integrates the Model 831 with outdoor microphone units (426A12 and PRM2100K) and weather transducers
 - **426A12 and PRM2101K:** Model 831 provides control signals to these outdoor microphone units when not used with 831-INT

Microphones and Microphone Preamplifiers

The Model 831 is designed for use with prepolarized microphones. The following microphone preamplifier is used:

For information on using the Model 831 with the PRM2103 preamplifier, see the PRM2103 Manual.

- PRM831 1/2” Microphone Preamplifier

The most commonly used microphones, which can be used with either of these preamplifiers are as follows:

- 1/2” Free Field Microphone with nominal sensitivity of 50 mV/Pa
- 1/2” Random Incidence Microphone with nominal sensitivity of 50 mV/Pa
- 1/4” Free Field Microphone with nominal sensitivity of 3.16 mV/Pa (ADP043 adaptor required)
- 1/4” Pressure Microphone with nominal sensitivity of 1 mV/Pa (ADP043 adaptor required).

There are two equivalent electrical impedance adaptors available. These are discussed in Chapter 1 “Optional Accessories” on page 1-5.

Display

The Model 831 has a 160 x 240 graphic, liquid crystal grayscale display. The display is backlit to provide

comfortable viewing in most ambient light situations. Controls are provided for contrast and backlight adjustments.

When the Model 831 is first switched ON, the Live tab appears. When a measurement is in progress, a display similar to Figure 3-3 is shown.

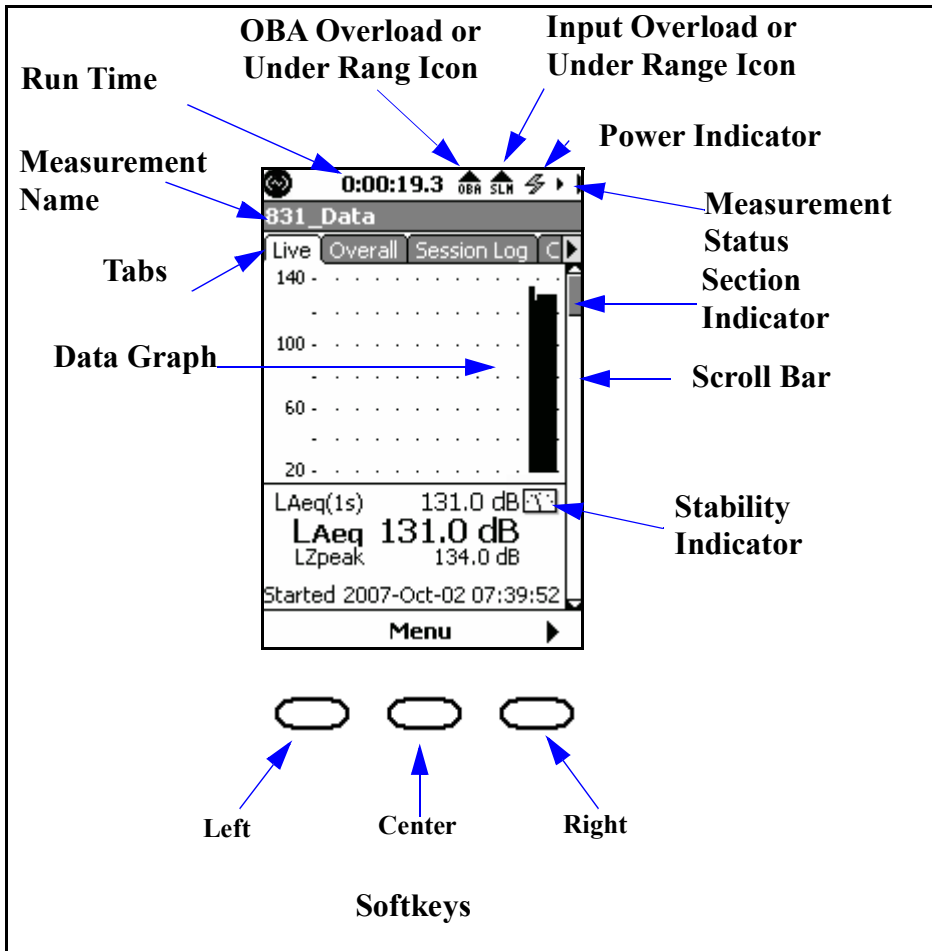

FIGURE 3-3 Data Display Screen

Keypad

The 831 meter has a 13 button keypad. This section describes the buttons on the keypad.

FIGURE 3-4 shows the 831 keys.

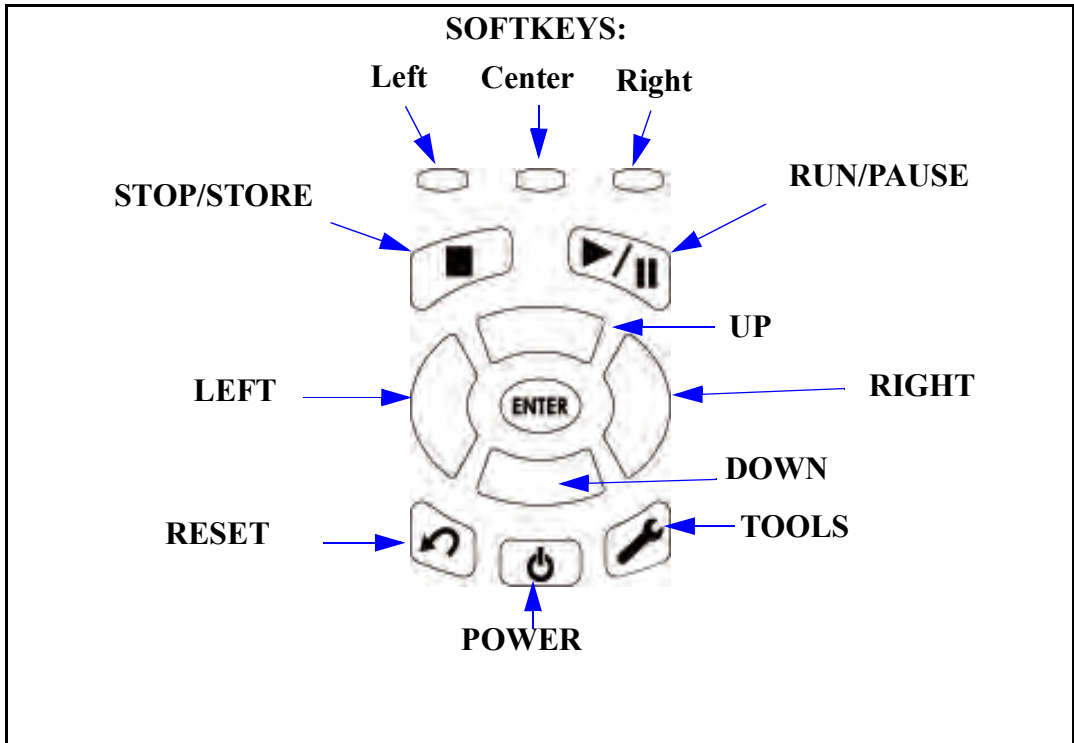

FIGURE 3-4 Model 831 Keys

Softkeys

The three push button keys just beneath the display, on the body of the Model 831, are called *Softkeys*.

Figure 3-5 shows the softkeys.

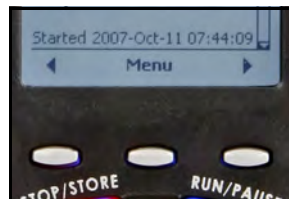

FIGURE 3-5 Softkeys

The function of each Softkey is indicated by an icon or label on the bottom of the display. Softkeys are so named because the function of each key can change depending upon the screen, the context, or how it is programmed, as indicated by the label. Pressing any one invokes the action associated with the text or symbol directly above it on the screen.

Hardkeys

The ten remaining keys below the softkeys are described in Table 3-1.





	<p>The POWER key is used to turn the Model 831 ON and OFF when the Hardware Power Switch, on the base of the unit is in the “ ” position. To turn the 831 off or on, press and hold the power key for a few seconds.</p>
	<p>The Navigation keys; Up, Down, Left and Right are multipurpose keys used to navigate through the Data Views, highlight icons and defined areas on the display, make a selection from multiple options, and to input alphanumeric characters into data fields.</p>
	<p>The ENTER key is used to implement data entry associated with selections from multiple options or the input of alphanumeric characters into data fields.</p>
	<p>The RUN/PAUSE key is used to initiate and pause a measurement, and to continue a paused measurement. This key has a green LED behind it which can be illuminated to indicate the measurement state of the Model 831. For more detailed information on the RUN/PAUSE key, see “Starting the Measurement” on page 7-5.</p>
	<p>The STOP/STORE key is used to stop a measurement and to store a measurement when the measurement is stopped. This key has a red LED behind it that can be illuminated to indicate the measurement state of the Model 831. For more detailed information on the STOP/STORE key, see “Starting the Measurement” on page 7-5.</p>

Table 3-1 Keypad Hardkeys



	<p>The RESET key is used to reset a measurement. For detailed information on using the Reset key, see “Resetting the Measurement” on page 7-13.</p>
	<p>The TOOLS key is used to set a number of parameters not associated with a specific measurement, such as setting date and time, managing power options and setting personal preferences (i.e. language, decimal and date formats, etc.).</p>

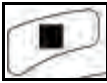

Table 3-1 Keypad Hardkeys

Summary of Displays and Icons

Tabs

Data is presented in tabbed format. Move between tabs by using the right and left Softkeys.

Page

Tabs are divided into pages that logically group the data together (i.e., 1/3 Octave data on the **Live** tab). Tabs may contain only one page or multiple pages. Navigate up or down to different pages by using the  (UP) or  (DOWN) keys. The position of the scroll bar indicates the sequence of pages on tabs.

Scroll Bar and Section Indicator

The scroll bar represents the complete tab. The section indicator shows the location of the page you are viewing.

Power Indicator

The following icons indicate the power source driving the Model 831 and the supply available to operate it.

Battery Power

The battery icon indicates the state of the battery charge by the width of the interior shaded portion. The two icons in FIGURE 3-6 indicate a fully charged battery and a nearly discharged battery.

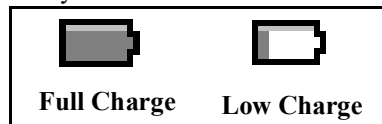

FIGURE 3-6 External Power

The external power connection icon appears when the Model 831 is powered from an external power supply or via the USB port.



Measurement Name

This is the file name to be used for the data file.

Stability Indicator

Presented in the form of an analog display, this dynamic icon indicates the trend in the measured overall Leq, indicating if the measured signal is rising, decaying or holding stable.



The icon appears in the first section of the Live, Overall and Current displays, and also in a window that appears during a sound level calibration.

Run Time

This is the amount of time the measurement has been running.

Input Overload Icon

When a signal from the preamplifier exceeds the calibrated input range of the Model 831, the Input Overload Icon will appear. While the overload is present, the icon will flash.

If a measurement is running and an overload occurs, the icon shown below will flash during the overload.



When the overload has been removed, the icon will still be present (not flashing) to indicate that an overload has occurred during the measurement. A reset will clear the icon from the display.

When using a microphone having a sensitivity of 50 mV/Pa, the input overload will occur approximately as shown in Table 3-4.

Input Gain, dB	Overload Level, dB Peak
0	143
20	123

Table 3-4 Input Overload Levels

Under Range Icon

When the signal from the preamplifier drops to the point where the noise level of the instrument and the preamplifier influence the measurement, an under range condition exists. When this happens the Under Range Icon will appear.



As long as the under range condition exists, the icon will flash. When the measured level no longer produces an under range condition, the icon will be removed from the display.

At any time when a measured parameter is in an under range condition, its numeric display will appear in gray rather than the usual black, as shown FIGURE 3-7.

L _{Aeq} 54.9 dB	L _{Aeq} 16.8 dB
L _{Aeq} 54.9 dB	L _{Aeq} 16.8 dB
Normal Range	Under Range

FIGURE 3-7 Normal vs Under Range Data Display

OBA Overload Icon

If the input to the Octave Band Analyzer (optional firmware 831-OB3 required) becomes overloaded, the icon shown will appear to indicate the overload.



This icon operates similar to the Input Overload Icon shown in the above section "Input Overload Icon".

When the OBA Range property is set to Low, the OBA Overload Icon will activate at a level 33 dB lower than it would had the OBA Range been set to Normal.

When using a microphone having a sensitivity of 50 mV/Pa, the input overload will occur approximately as shown in Table 3-5.

Input Gain, dB	OBA Range	Overload Level, dB
0	Normal	143
20	Normal	123
0	Low	110
20	Low	90

Table 3-5 OBA Overload Levels

OBA Under Range Icon

When the signal from the preamplifier drops to the point where the noise level of the instrument and the preamplifier influence the measurement, an under range condition exists.

When all filters of the OBA are “under range” the OBA Under Range Icon appears.



As long as this under range condition exists, the icon will flash. When the measured OBA levels no longer produces an under range condition, the icon will be removed from the display.

Like the SLM, when a measured OBA parameter is in an under range condition, it's numeric display will appear in gray rather than the usual black, as shown Figure 3-8.

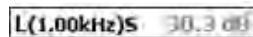

FIGURE 3-8 OBA Under Range Display

Measurement Status

Reset Icon



The Reset Icon indicates that a reset has occurred.

Run Pending Icon



The Run Pending icon appears when the  (RUN/PAUSE) key is pressed and the Model 831 is waiting for filters and detector initialization to complete. The Model 831 will automatically start the run after the wait or warm-up state is completed (less than 10 seconds)

Run Icon



The Run Icon moves from left to right to indicate that a measurement is running.

Pause Icon



The Pause Icon indicates that the present run has been paused.

Stop Icon



A Stop Icon is displayed when a measurement has been stopped.

Store Icon



When a data file has been stored, the Store Icon is displayed.

USB Copy Indicator



When a data file is being copied to the USB port, the USB Copy Indicator Icon is displayed in the upper left corner in place of the PCB Piezotronics logo.

Power Save Icon

When the Model 831 is in the power save mode, the power save icon







will be displayed in the location where the measurement status icons usually appear. For more detail on power save, see Power-Save Time on page 18-7.

Changing Views

In the Data Views, the labels of the Left and Right Softkeys are left and right arrow symbols, respectively. These indicate that the Left and Right Softkeys are used to scroll the selection of the tab being displayed in the corresponding direction. One press of the Right Softkey will bring up the Session Log View, and a second press will bring up the Current tab. Then, sequential presses of the Left Softkey will bring up the Session Log View, then the **Overall** tab.

Navigating and Selecting

To navigate between tabs on the display, press the right or left Softkeys. To navigate within tabs, use the  and  keys for moving horizontally on screens. This includes moving the highlight from one property to the next.

The  and  keys are used for moving vertically on screens. This includes moving the highlight from one property to the next and to move to previous or subsequent tabs.



These keys are also used for character entry by navigating through lists of characters in text boxes.

The  (ENTER) key is typically used for completing selections completing actions, or accepting values.

Basic Run Functions

The basic measurement run functions are as follows:

- Running
- Pausing
- Stopping
- Storing

The  (RUN/PAUSE) key initiates a run. If a measurement is running, this key pauses the run. It does not end the run; to end the measurement run, press the  (STOP/STORE) key. Pressing the  key when the unit is PAUSED continues the run. This key is only active on a Data View screen.

Pressing the  (RUN/ PAUSE) key when the unit is in STOP mode continues the previous run.

The  key ends a run. Pressing the key a second time stores the data in a file. This key is only active on a Data View screen.

Tab and Setting Displays

The 831 features and functions are organized into four different types of displays.

- **Data Display tabs:** used to display measured data.
- **Measurement Settings tabs:** used to set the parameters for a measurement.
- **Control Panel (Tools) Properties:** used to set user preferences, to set non-measurement related parameters, and to implement calibration.
- **Power Control Page:** used to check battery power, control the contrast and backlight of the display and other features.

Data Display Tabs

When the  (ON/OFF) key is pressed to turn on the 831, the Data Display tabs appear.

Measurement Settings Tabs

Opening

From the Data Display tabs, pressing the Center Softkey labeled **Menu** brings up the menu shown in FIGURE 3-9.

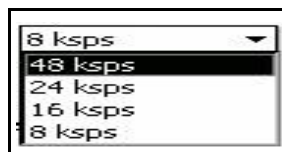



FIGURE 3-9 Menu

Select **Settings** and press  to open the Settings tabs.

Closing

Press the Center Softkey to return the Data Display tabs.

Control Panel (Tools) Properties

The Control Panel is accessed by pressing the  (TOOLS) key at the lower right of the 831 front panel. To exit from the

Control Panel and return to the Data Display tabs, press the Center Softkey labeled **Close**.

Power Control Page

The Power Control Page is opened by pressing the  (ON / OFF) key while on Data View tabs. To exit from the Power Control Page, press the Center Softkey labeled **Close**.

Data Display Tabs

The Data Display tabs are identified by their titles on each tab. You can navigate from tab to tab by pressing the left and right Softkeys.

Pressing the Pause key does NOT pause the elapsed time indicator.

This description of the Data Display tabs corresponds to the LD default setup used when the Model 831 is delivered from the factory. These display tabs can be modified, as described in “Displays” on page 18-23.

For a more detailed description of the Data Display tabs and their associated views, see Chapter 5 “Data Display” on page 5-1

- **Live tab:** Data is continuously displayed on this tab whether there is a measurement in progress or not.
- **Overall tab:** The data displayed on this tab represents data measured and averaged beginning from the time the measurement was started by pressing the Run key until the elapsed time indicated above the display. If the Stop key is pressed, the elapsed time will be stopped. However, pressing the Run key again will continue this overall measurement as shown by the elapsed time restarting from the time when it had previously been paused or stopped. As long as there is no reset, the same measurement is continued.
- **Session Log:** The Session Log is a record of data accumulation actions. Resetting and storing data will clear the session record. A time-stamped record is made for every Run, Pause, Resume, Stop, Voice Message and Sound Recording action. The source responsible for each action is also recorded.
- **Current:** Unless Measurement History has been enabled in the Run Control setup, the Current View display is similar to the Overall View. The difference is that while the Overall View displays data measured since the last pressing the Run key following a reset, the Current View displays data measured since the last press of the key sequence Stop/Run. For example, suppose a measurement was begun at a time T1 and then the key sequence Stop/Run was pressed at a later time T2. The

data presented in the Overall View would represent the measurement since T1 while the Current View would represent the measurement since T2.

With measurement history enabled, a series of separate measurements are made based on either manual key presses or time intervals, depending on the setup used. The current view will display the data corresponding to the measurement currently in progress. When that measurement is complete, the data are transferred to the measurement view. The current measurement is then reset and the subsequent measurement begun, at which time the data for this new measurement is displayed.

- **Measurement:** With Measurement History enabled, the measurement view can display all the separate measurements made from the beginning to the end of the total measurement period.
- **Events:** Basic data associated with measurements initiated by the trigger criteria are displayed in the view. When there have been multiple measurements, these data can be viewed separately.
- **Time History:** This view displays data measured using the time history measurement feature.

Additional tabs appear in different instrument modes when the 831-FFT and 831-RT options are enabled. For more information, refer to the "FFT and Tonality" and "RT-60" chapters.

The 831-ELA firmware option must be purchased and enabled for this tab to appear.

The 831-LOG firmware option must be purchased and enabled for this tab to appear.

Measurement Settings Tabs

The Measurement Settings tabs allow for specific settings. From any data tab, press the Menu softkey, select **Settings** and press **ENTER** to open the settings tab for the current measurement. You can navigate from tab to tab by pressing the left and right Softkeys.

Because the screen is not wide enough to show tall Measurement Settings tabs at the same time, use the Right and Left Softkeys to scroll the view to the right or left respectively.

- **\General:** used to create a file name and a measurement description
- **SLM:** used to setup the parameters for the measurement of sound levels

- **OBA (optional):** used to setup the real-time octave band frequency analysis
- **Dosimeter 1 (optional):** used to setup the parameters for the measurement of sound exposure and noise dose
- **Dosimeter 2 (optional):** used to setup the parameters for the measurement of sound exposure and noise dose
- **Ln:** used to define the parameters for the measurement of Ln statistics
- **Control:** used to setup the mode of measurement timing and the storage of measurement history records
- **Time History (optional):** used to setup the timing and select the metrics that are stored in the time history
- **Triggers:** used to setup the triggers which define noise exceedance events
- **Event History (optional):** used to setup the timing and options for event details
- **Markers:** used to define the marker names and enable sound recorder options
- **Day/Night:** used to define the time periods and level penalties for community noise metrics
- **Sound (optional):** used to set the quality of sound recording and enable its usage
- **Weather:** used to setup external transducers for the measurement of wind speed, wind direction, temperature and humidity

For more information on the Measurement Settings tabs and their associated pages, see Chapter 4 “Basic Measurement Setup” on page 4-1.

Control Panel (TOOLS) Properties

For a detailed description of the Tools Screen, see “Control Panel - System Properties” on page 18-1.

Three more icons, Lock, System Utilities and Communication do not appear in FIGURE 3-10. Scroll down below the System Properties and About icons to see them.



The Control Panel displays icons to represent the different functions available for the Model 831. Pressing the  (TOOLS) key displays the Control Panel screen, as shown in FIGURE 3-10. Press  to select an icon.



FIGURE 3-10 Tools Screen

Data Explorer

For a detailed description of the Data Explorer, see Chapter 17 “Data Explorer” on page 17-1.

Data Explorer is used to examine stored data. It is also used to manage stored measurements such as rename or delete files.

Setup Manager

For a detailed description of the Setup Manager, see “Setup Manager” on page 4-16.

The Setup Manager permits the user to create and store a number of user-defined measurement setups for easy recall, editing and use.

System Properties

For a detailed description of the System Properties tabs, see Chapter 18 “System Properties” on page 18-1.

System Property tabs are used for general instrument bookkeeping. Functions such as setting the instrument date and time, display contrast adjustment, date format, etc. are located here. These are single-paged tabs.

The System Property tabs include the following:

- **Device:** Enter instrument identification.
- **Time:** Set date and time.
- **Power:** Set controls affecting power consumption.
- **Preferences:** Set a variety of system parameters such as Autostore and USB Storage.
- **Localization:** Set the regional characteristics, such as Language, Decimal Symbol, Date Format and Units.
- **Displays:** Set customization of Displays.
- **Logic I/O:** Configure logic in and logic out options for the Model 831 control port.

FIGURE 3-11 shows System Properties tabs sequence.

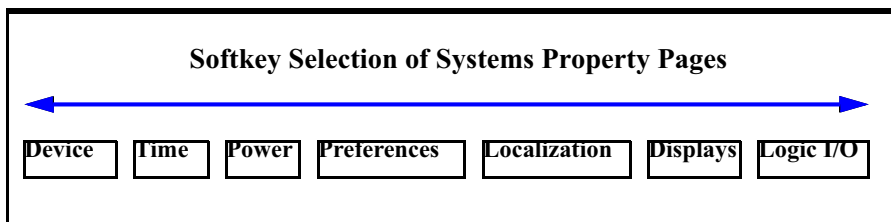

FIGURE 3-11 System Property Tabs

The Right and Left Softkeys are used to scroll between System Property tabs.

Lock

For a detailed description of the Lock feature, see Chapter 21 "Lock/Unlock the Model 831" on page 21-1.

Lock permits the Model 831 to be configured such that certain keys are locked so their functionality cannot be utilized.

Communication

For a detailed description of the Communication tabs, see Chapter 20 "Communication" on page 20-1.

The Communication tabs are used to setup and monitor communications between the Model 831 and a PC using a dial-up modem, wireless EDGE modem or RS-232 interface.

The Communication tabs include the following:

- **Status:** Display status of Analog and Wireless modems, RS-232 and USB channels.
- **Modem:** Setup a dial-up modem
- **Wireless:** Setup a wireless modem
- **RS-232:** Setup an RS-232 interface

Calibrate

For a detailed description of the calibration procedure, see Chapter 8 “Calibration” on page 8-1.

Calibrate is used to verify and adjust the calibration of the Model 831 prior to a measurement.

Voice Recorder

For a detailed description of the voice recording feature, see Chapter 10 “Voice Recording” on page 10-1.

A method to allow voice annotation of the data is described in Chapter 10 “Voice Recording” on page 10-1.

About

For a detailed description of the About tabs, see Chapter 22 “About” on page 22-1.

The About tabs provide the user with information specific to this instrument such as serial number, options, etc. These are single section tabs.

The About tabs include the following:

- **About:** shows information such as serial number and firmware revision
- **Standards:** lists the standards that the Model 831 meets
- **Options:** shows the options that are available in this instrument
- **User:** user entered instrument identification

FIGURE 3-12 shows the About tabs sequence.

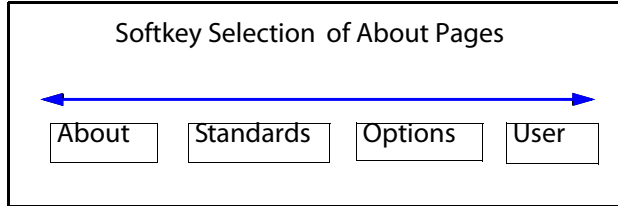

FIGURE 3-12 Softkey Selection of About Tabs

The Right and Left Softkeys are used to scroll between the About tabs.

System Utilities

For a detailed description of the System Utilities, see Chapter 23 “System Utilities” on page 23-1.

The System Utilities provides routines to work with the internal files systems and the USB. Routines are provided to implement the following activities:

- Check File System
- Format
- Format/Restore Defaults
- Check/Repair USB
- Format USB

Additional icons may appear in the Control Panel, depending on the firmware options enabled on your Model 831.

Parameter Selection

When operating the Model 831, you frequently define parameters by selecting them from lists that may appear on the display either as a row with a radio button, or as a vertical list in a drop down menu.



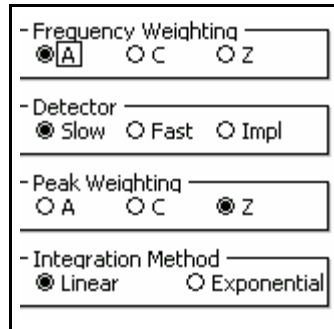

Parameters in a Row

These may appear as a single row or, when there are numerous parameters to define, as multiple rows as shown in FIGURE 3-13.



The image shows a vertical list of four parameter selection sections, each enclosed in a rectangular box. Each section has a title followed by a horizontal line and then several radio button options. The first section, 'Frequency Weighting', has three options: 'A' (selected), 'C', and 'Z'. The second section, 'Detector', has three options: 'Slow' (selected), 'Fast', and 'Impl'. The third section, 'Peak Weighting', has three options: 'A', 'C', and 'Z' (selected). The fourth section, 'Integration Method', has two options: 'Linear' (selected) and 'Exponential'.

FIGURE 3-13 Parameters with Radio Buttons

Use the  and  keys to highlight the parameter (Frequency Weighting, Detector, etc.), then the  and  keys to highlight the desired selection for that parameter. Press  to make the selection and fill in the radio button associated with that parameter.

Drop Down List

Parameters of this type are associated with a parameter name followed by a data field indicating the present selection for that parameter. There may be a single parameter to be defined, or multiple parameters as shown in FIGURE 3-14.

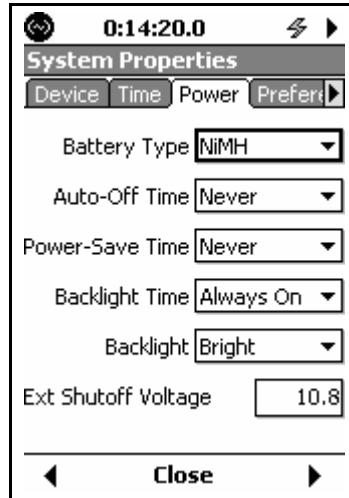





FIGURE 3-14 Parameter Data Field

Use the  and  keys to highlight data field of the parameter to be defined (Battery Type highlighted above) and press  to open the drop down menu listing the permitted choices as shown in FIGURE 3-15.

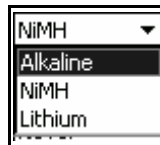





FIGURE 3-15 Drop Down Menu

Use the  and  keys to highlight the desired item in the list and press  to make the selection and close the menu.

Entering Alphanumeric Strings

It is easier to specify alphanumeric strings in SLM Utility-G3 or G4 software.

In some instances you will be called upon to enter alphanumeric strings, such as creating a name or entering text information. Parameters of this type are associated with a parameter name and a data field as shown in FIGURE 3-16.

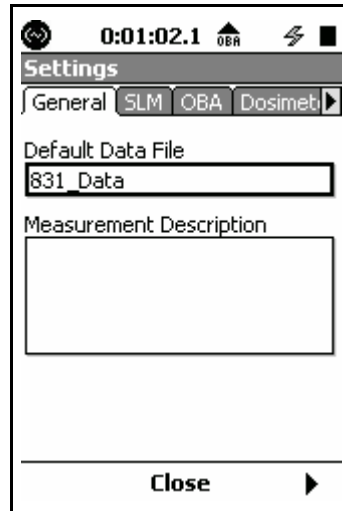





FIGURE 3-16 Alphanumeric Data Field

The data field may be blank, as in the Measurement Description above, or it may contain a default name, as in the Default Data File field. Use the  and  keys to highlight the desired data field and press  to bring up a cursor in the data field as shown in FIGURE 3-17.

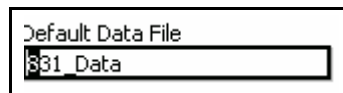









FIGURE 3-17 Cursor in Data Field

The  and  keys are used to move the cursor right or left, respectively. At any cursor position, the  and  keys are used to scroll the alphanumeric character appearing in that position through a defined sequence.

Repeated presses of the  key will produce the following sequence of characters:

- **Capital letters A through Z**
- **Lower case letters a through z**
- **Characters ! @ # \$ * () - + = [] < > .**
- **Numbers 0 through 9**
- **Space**

Repeated presses of the  key will produce the same sequence in reverse order.

When the desired alphanumeric field has been entered, press  to accept it and remove the cursor.

Entering Numeric Data

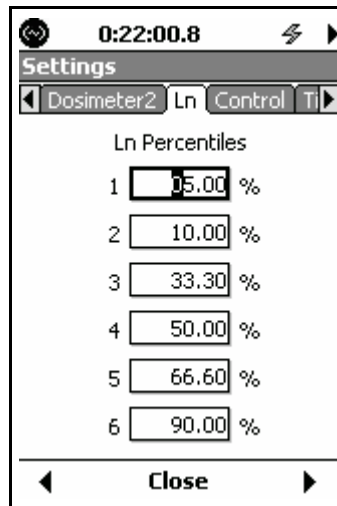



FIGURE 3-18 Entering Numeric Data

When a purely numeric parameter is being entered, as in FIGURE 3-18, the same procedure is followed as for alphanumeric parameters. In this case, repeated presses of the  and  keys will scroll upward or downward, respectively, through the numeric sequence.

Basic Measurement Setup

This chapter describes the setup of the Model 831 to perform basic sound level measurements. These measurements may include the following:

- Leq, Lmax, Lmin corresponding to user-selected values of frequency weighting and detector
- Lpeak and Lpeak(max) corresponding to a user-selected value of frequency weighting
- 1/1 and/or 1/3 Octave real-time spectra (831-OB3 required)
- Six values of Ln based on six user-selected values of the percentage parameter n
- Count of the number of times the levels (SPL and Peak) exceeded user-selected threshold values
- Sound exposure and sound exposure level data

Settings Screen

Accessing the Settings Screen

For a more detailed description of the Settings Screen, see “Control Panel (TOOLS) Properties” on page 3-17.

The parameters defining a measurement are set from the Settings Screen.

This screen can be accessed from any of the Data Views. Press the Center Softkey labeled **Menu**, highlight **Settings**, and press  (ENTER). The Settings Screen is now displayed with the tab selected that is most appropriate for the data display from which it was activated.

The settings can also be edited using the Setup Manager, described in “Setup Manager” on page 4-16.

Settings In Use Message

If the Model 831 is not connected to a computer running G4 LD Utility software, ignore this section.

If the G4 is connected to the Model 831 when attempting to access the Settings Screen, the display shown in FIGURE 4-1 will appear.

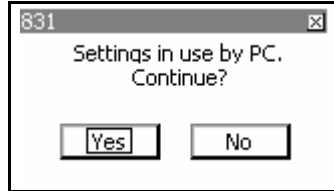

FIGURE 4-1 Settings In Use By 831 Utility Message

This message warns the user that accessing the Settings Screen will cause setup changes which had been made using the 831 Utility during this session to be lost. It also indicates that changes made in the instrument may be lost when the settings in use by the PC are uploaded.

To continue and access the Settings Screen, highlight **Yes** and press **ENTER**.

Setup Tabs

Only a few of these horizontally arranged tabs (three in Figure 4-2) can be seen at one time. To see those off-screen to the right use the Right Softkey beneath the display. To scroll back to the left, use the Left Softkey beneath the display.

Depending on the firmware options loaded in the Model 831, there may be as many as fourteen different setup tabs in the Settings Screen, each identified by a title on a tab at the top as shown in Figure 4-2.

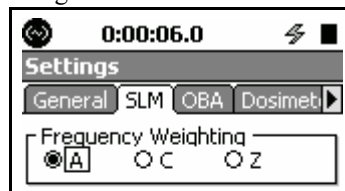

FIGURE 4-2 Tabbed Setup Tabs

For basic measurements, we will only be concerned with the following tabs:

- **General**
- **SLM**
- **OBA**
- **Ln**

- **Control**
- **Triggers**
- **Day/Night**

The Right and Left Softkeys are used to scroll through the available tabs, to the right and left, respectively, in the order they are listed above.

Each of these is described in detail in the sections which follow.

General Tab

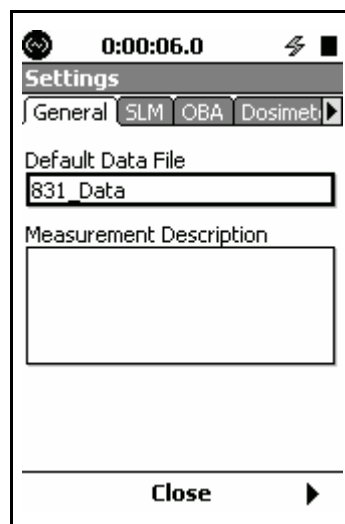

FIGURE 4-3 General Tab

The 831 Utility Software can be used to easily enter both the file name and the measurement description.

The **General** Tab is used to enter a file name and a measurement description for the measurement being defined. Upon opening, the Default File Name “831_Data” may appear in the file name field.

To enter a new file name, highlight the Default File Name text box and press **ENTER**. Enter a new name and press **ENTER**.

SLM Tab

The default values for these parameters are as shown in FIGURE 4-4.

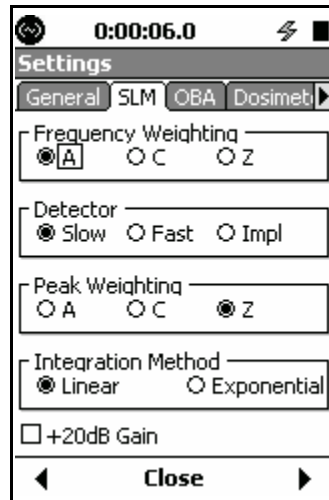

FIGURE 4-4 SLM Tab

Selections of Frequency Weighting, Detector, Peak Weighting and Integration Method are made one-at-a-time. Click to highlight the desired section prior to making the selection.

Use the arrow keys to highlight the appropriate item for the selected parameter and press **ENTER** to make the selection.

Frequency Weighting

A, C and Z frequency weightings are provided for the SPL and peak detectors. These are selected separately.

Time Weighting

Available time weightings for the SPL detector are: **Slow**, **Fast** and **Impulse**.

Integration Method

Note that the Model 831 can be set to run for a preset integration time as described in "Manual Stop, Timed Stop or Stop When Stable" on page 6-4

Two Integration methods are available: Linear and Exponential.

Exponential Integration

Exponential integration is provided mainly to provide compatibility with older instruments. Exponential detectors have a tendency to hide small events in the long decay of a loud impulsive event.

Note that when performing time history measurements using time increments 10 ms or less, the integration method must be linear. If exponential integration has been selected at the time of setup, this will be changed as described in "Linear Integration Only" on page 11-6.



Linear Integration

Linear integration integrates only energy that occurs during a given time period and therefore does not exhibit the decay slope of a Fast, Slow or Impulse exponential detector.

The value of the integrated level is displayed immediately following the end of the integration time.

For long duration measurements both integration methods report the same value in that they both have equivalent "energy under the curve", although short term metrics may vary.

20 dB Gain

When measuring low level sounds, when the sound level is approaching the background noise level of the instrument, it is recommended to increase the gain by 20 dB. This is done by using the  key to highlight this section and pressing  to insert a check. Press  again to remove the check and set the gain back to 0 dB

The effect of the gain on the noise level is shown in FIGURE A-34 "As Labeled" on page A-43, FIGURE A-35 "As Labeled" on page A-44, FIGURE A-36 "As Labeled" on page A-44 and "Noise Level as a Function of Octave Frequency Bands" on page A-45.

The effect on the A-Weighted linearity range is shown in the section "f) Linear Operating Range" on page B-9.

Octave Band Analyzer Tab (Optional)

The default values for these parameters are as shown in FIGURE 4-5.

This tab will only appear when the Model 831 has the optional 831-OB3 firmware enabled.

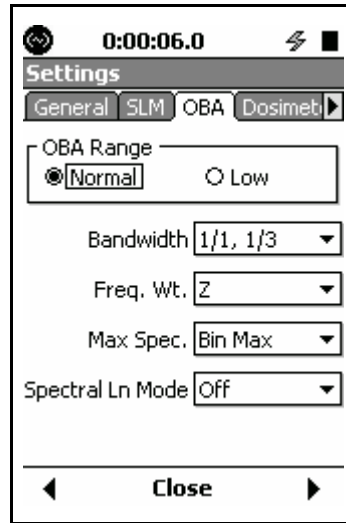

FIGURE 4-5 OBA Tab

OBA Parameter Selection

The OBA parameters are selected as shown in FIGURE 4-6.

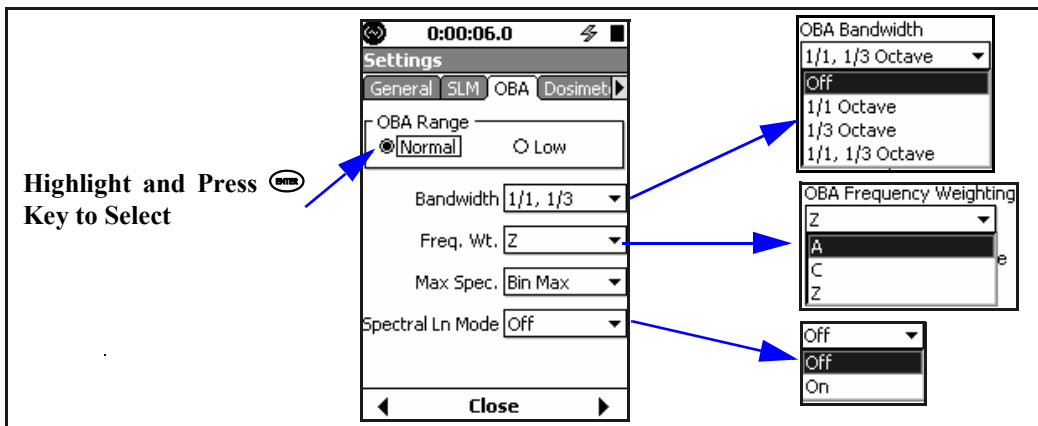

FIGURE 4-6 OBA Parameter Selection

OBA Range Setting

The user selects normal or low range OBA for the measurement:

- **Normal Range**, typically 45 to 140 dB
- **Low Range**, typically 19 to 107 dB

For measurement range specifications, refer to the microphone capabilities. Additionally, see Table 20: "1/1 Octave Linearity Range" on page A-21 or Table 21: "1/3 Octave Linearity Range" on page A-25.

OBA Bandwidth Setting

The user can select to utilize a single 1/1 Octave analysis module, a single 1/3 Octave analysis module or both simultaneously.

Select **Off** to have no real-time analysis module active.

OBA Frequency Weighting

The user can select that the 1/1 and/or 1/3 Octave frequency analysis modules process data from the A, C or Z weighting filters.

See "Spectral Statistics" on page 24-5 for a more detailed description of spectral Ln measurements.

Spectral Ln Mode

Spectral Ln values can be measured using either 1/1 or 1/3 octave bandwidths, depending on the OBA bandwidth selected, as shown below.

- **OBA = 1/1 Octave:** Spectral Ln Mode is 1/1 Octave
- **OBA = 1/3 Octave or 1/1, 1/3 Octave:** Spectral Ln Mode is 1/3 Octave

Setting the spectral mode **Off** will reduce the memory used for data storage.

Ln Tab

The Ln value is the measured sound level which was exceeded n% of the measurement time. For example, a value of $L_{90} = 35$ dB means that the measured sound level was above 35 dB for 90% of the measurement period. These statistical values are commonly used to describe the characteristics of non-steady sound such as environmental noise.

In order to be able to calculate Ln values, the Model 831 creates an amplitude distribution table over the range 0 to 200 dB, in amplitude increments of 0.1 dB. These data permit the calculation of Ln values for any value of n in the range 00.01 to 99.99%.

Selection of Ln Values

The default values for these parameters are as shown in FIGURE 4-7.

The Model 831 displays six Ln values at a time, using user-selected values of n. These are set from the **Ln Tab**, shown in FIGURE 4-7.

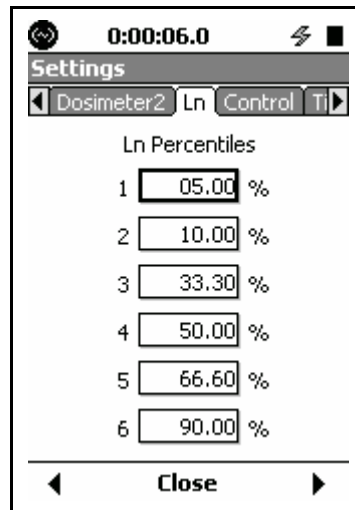

FIGURE 4-7 Ln Tab

Modifying Ln Values During a Measurement

While a measurement is running, it is possible to return to the Ln display of the Settings Screen, shown in FIGURE 4-7 and change any or all of the six Ln values. This will change the display of Ln values, shown in FIGURE 5-18 "Overall Tab: Ln Percentiles" on page 5-18.

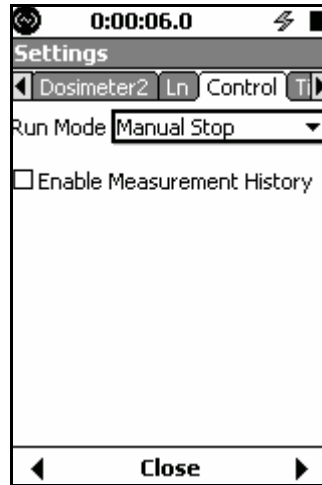





FIGURE 4-8 Control Tab

A detailed description of the Run Mode is presented in Chapter 6 "Run Control" on page 6-1.

The **Control** tab is used to set the Run Mode for the measurement to be performed. There are six modes of measurement duration available. In this chapter we will address only the first three.

- **Manual Stop:** The measurement is initiated manually by pressing the  (Run/Pause) key and it stopped upon pressing the  (Stop/Store) key.
- **Timed Stop:** The measurement is initiated manually by pressing the  (Run/Pause) key and will be stopped automatically after a user-defined time period.
- **Run Until Level Stable:** The measurement is initiated manually by pressing the  (Run/Pause) key. The measurement will stop when the measured level has remained within a user-defined range and the measurement has run for a user-defined time period.

The selection of the Run Mode and the associated parameters is shown in FIGURE 4-9. The Measurement History feature is not discussed in this chapter. For further information on that, see Chapter 12 "Measurement History" on page 12-1.

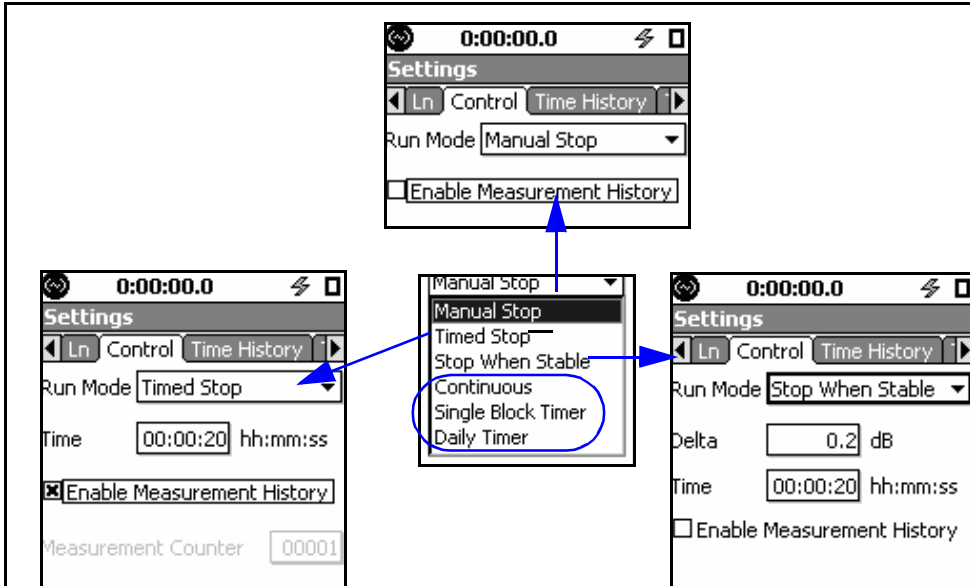

FIGURE 4-9 Run Mode Parameter Selections

Measurement History

For a detailed description of Measurement History, see Chapter 12 "Measurement History" on page 12-1.

In FIGURE 4-9, an item entitled Enable Measurement History appears for each Run Mode. Measurement History is a measurement option provided when the optional firmware 831-ELA is enabled. Since this chapter is concerned only with basic measurements, we do not address Measurement History here. Thus, in the following sections when we refer to parameters, this does not include Measurement History.

Manual Stop Mode

The Manual Stop Mode has no parameters.

Timed Stop Mode

Timed Stop has two parameters, Time and Enable Measurement History. It also adds Measurement Counter if one minute or more. The range of time values which can be entered is 00:00:01 to 99:59:59 in the format hh:mm:ss.

Stop When Stable Mode

The Stop When Stable Run Mode has two parameters: Delta and Time.

Delta

The Delta level is the maximum allowed change in Current average level (i.e. L_{Aeq}) permitted during the time interval defined below. The minimum level that can be set is 0 and the maximum is 5.0 dB. The default is 0.2 dB.

Time

The Time is the minimum interval that the measurement must run. The measurement will run for the interval specified and then continue until the stability condition is met. The smallest value that can be entered is 20 seconds and the largest is 99:59:59 (h:m:s), The default is 20 seconds.

Triggers Tab

Note that the default values for these parameters are as shown in FIGURE 4-10.

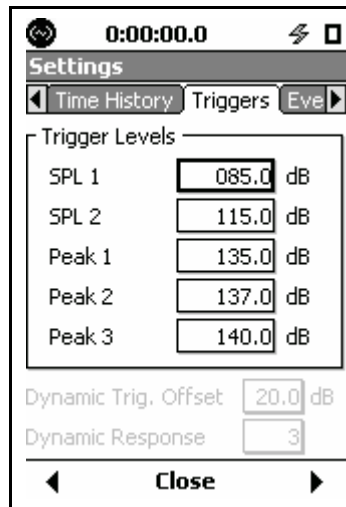

FIGURE 4-10 Triggers Tab

The **Triggers** tab is used to define trigger levels associated with exceedance events; instances where the measured sound level (SPL or Peak) exceeds one of the user-defined trigger levels. The variation of sound level during a typical

event might look as shown in FIGURE 4-11 "Exceedance Event Example" .

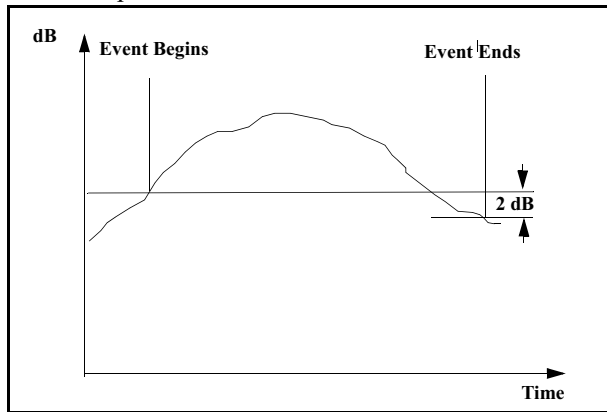

FIGURE 4-11 Exceedance Event Example

For exceedance counters a noise event is initiated when the sound level rises above the event trigger level. A noise event ends when the sound level drops 2 dB below the trigger level. This hysteresis is introduced to avoid the creation of multiple events when the sound level is fluctuating about the threshold level.

SPL Trigger Levels

There are two threshold levels, SPL Trigger Levels 1 and 2, which can be set to initiate an exceedance event when the measured SPL (Slow, Fast or Impulse) exceeds either of these thresholds.

Peak Trigger Level

Three different Peak Trigger Levels can be set independently from the SPL trigger levels. Since the peak detector has a very fast response time compared to the SPL detectors, exceedance events based on the peak trigger level can identify impulsive noises produced by blasts and gun fire which would not ordinarily produce an exceedance of the SPL trigger levels.

Basic Exceedance Event Data

Note that hysteresis is only utilized to define the conclusion of a noise event for basic event counting as described in this section. It is not used in conjunction with the acquisition of noise event history data.

Noise Event History Data

The following exceedance event data are provided for each of the five threshold levels:

- The number of exceedances of each threshold level.
- The sum total of the time the measured level was exceeded the threshold level.

When the Model 831 has the optional 831-ELA firmware loaded, detailed sound level data associated with exceedance events are measured and stored. For details, see Chapter 13 "Event History" on page 13-1

Sound Recording of Exceedances

If the optional 831-SR firmware has been enabled, automatic sound recordings of each exceedance can be made. See "Event Sound Recording" on page 16-14.

Day/Night Tab

Note that the default values for these parameters are as shown in FIGURE 4-12.

Among the parameters measured and displayed as part of a basic sound level measurement are the community noise descriptors L_{DN} and L_{DEN} . The **Day/Night** tab is used to define the times and penalties to be used.



The screenshot shows a settings window titled "Settings" with a status bar at the top displaying "0:00:00.0" and a battery icon. Below the title bar are three tabs: "Markers", "Day/Night" (which is selected), and "Sound". The "Day/Night" tab contains three sections: "Day", "Evening", and "Night". Each section has a "Time" field and a "Penalty" field. The "Day" section has a Time field with "07:00" and "hh:mm" labels. The "Evening" section has a Time field with "19:00" and "hh:mm" labels, and a Penalty field with "05.0" and "dB" labels. The "Night" section has a Time field with "23:00" and "hh:mm" labels, and a Penalty field with "10.0" and "dB" labels. At the bottom of the window is a "Close" button with left and right arrow icons.

FIGURE 4-12 Day/Evening/Night Definition

L_{DN}

The default day-night level L_{DN} is defined by the following formula:

$$L_{dn} = 10 \log_{10} \left\{ \frac{1}{24} \left[\sum_{0000}^{0700} 10^{(L_i + 10)/10} + \sum_{0700}^{2200} 10^{L_i/10} + \sum_{2200}^{2400} 10^{(L_i + 10)/10} \right] \right\}$$

L_{DEN}

The default day-evening-night level L_{DEN} is defined by the following formula:

$$L_{DEN} = 10 \lg \left(\frac{1}{24} \right) \left[12 * 10^{\frac{L_{day}}{10}} + 4 * 10^{\frac{L_{evening} + 5}{10}} + 8 * 10^{\frac{L_{night} + 10}{10}} \right]$$

In the default form, the day has twelve hours, the evening has four hours and the night has eight hours, as can be seen in the equation. The default times for these periods are as follows

- **Day: 07.00 to 19.00**
- **Evening: 19.00 to 23.00**
- **Night: 23.00 to 07.00**

L_{day}, L_{evening} and L_{night} are A-weighted long-term average sound levels measured during the day, evening and night, respectively.

To account for the increased impact of environmental noise during the evening and night, penalties are added to the measured level; 5 dB for evening and 10 dB for night, as can be seen in the equation.

The Directive 2002/49/EC of the European Parliament and of the Council of 25 June 2002, relating to the assessment of environmental noise permits member states to shorten the evening period by one or two hours and lengthen the day

and/or the night accordingly and also to choose the time for the start of the day.

To accommodate these and other possible modifications, the **Day/Night** tab permits the user to modify the times for the beginning of the Day, Evening and Night periods and the penalties to be utilized when calculating 24-hour integrated values.

CNEL

In the state of California, a commonly used community noise descriptor is Community Noise Equivalent Level (CNEL), defined by the following formula:

$$CNEL = 10 \log_{10} \left\{ \frac{1}{24} \left[\sum_{0000}^{0700} 10^{(L_i + 10)/10} + \sum_{0700}^{1900} 10^{L_i/10} + \sum_{1900}^{2200} 10^{(L_i + 5)/10} + \sum_{2200}^{2400} 10^{(L_i + 10)/10} \right] \right\}$$

This is essentially the same as the L_{DEN} using default values, with the exception that the evening period begins at 22.00 instead of 23.00. Thus, by making this change in the L_{DEN} settings, the measured value will represent CNEL.

Exiting Settings Screen

To exit the Settings Screen, press the Center Softkey labeled **Close**.

If any setup parameters have been changed, the “Apply Changes” message box will be displayed as shown in FIGURE 4-13.

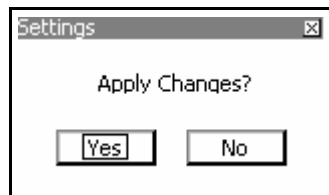

FIGURE 4-13 Apply Changes

At this point the parameter changes made from the Settings Screen have not yet been implemented in the instrument. Select either **Yes** or **No**, and press **ENTER** to implement the changes or cancel the changes, respectively. This will return the Data Display Screen to the display.

Setup Manager

Due to the need to assign names to user-defined setups, it is much easier to create and save these using G4 or G3 software.

The Setup Manager permits the user to create and store a number of user-defined measurement setups for easy recall and use.

To activate the Setup Managers, press the  (TOOLS) key. to open the Control Panel. Highlight the Setup Manager icon, as shown in FIGURE 4-14



FIGURE 4-14 Control Panel

Press **ENTER** to open the Setup Manager, shown in FIGURE 4-15.

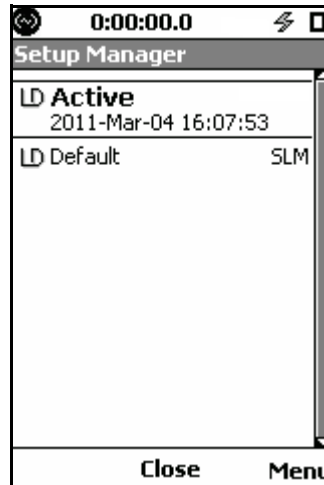

FIGURE 4-15 Setup Manager

If no user-defined setups have been created and saved, the display will list two setups:

- **LD Active: the setup presently active in the Model 831**
- **LD default: the factory default setup as originally shipped from Larson Davis**

If we have created a setup using the Setup Screen, as described earlier in this chapter, the LD Active setup is listed as just "LD Active". If we then highlight it and press **ENTER**, it will be listed as "LD Active-default", indicating that it is still using the default name for it.

Note: Setup names are limited to twelve characters.

When user-defined setups have been added, the Setup Manager might look like FIGURE 4-16.

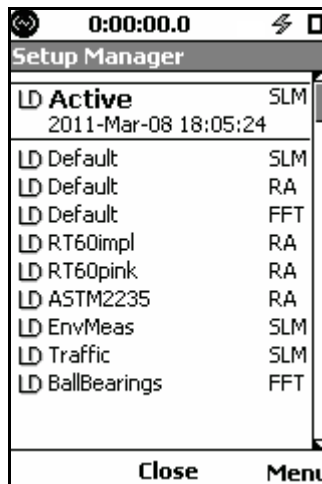

FIGURE 4-16 Setup Manager: User-defined Setups Added

Change to LD Default Setup

If you wish to return all settings in the Model 831 to the default settings which were active when the instrument was delivered from the factory, highlight **LD default** and press **ENTER**. If there is an unsaved measurement in the instrument, the message shown in FIGURE 4-17 will appear.

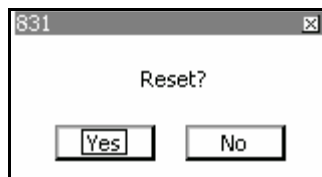

FIGURE 4-17 Reset Prompt

If you do not wish to save this measurement, select **Yes**, which displays the message shown in FIGURE 4-18.

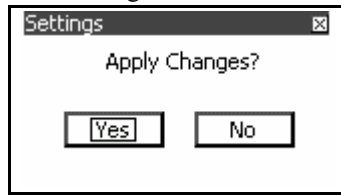

FIGURE 4-18 Apply Changes Prompt

Select **Yes** to return settings in the Model 831 to the factory defaults. Otherwise, select **No** to cancel the settings change.

If you wish to save the measurement prior to returning the settings to the defaults, highlight **No** in the Reset Prompt shown in FIGURE 4-17 and press **ENTER** to cancel the reset operation. Save the measurement in the usual manner, by pressing the **Stop/Store** key once (if already stopped) or twice (if not already stopped) before again initiating the return

Utilizing a User-Defined Setup

To utilize a user-defined setup, from the display shown in FIGURE 4-16 highlight the desired user-defined setup and press **ENTER**. The display will then indicate that the LD Active setup utilizes the parameters of the selected user-defined setup, in this case EnvMeas, as shown in FIGURE 4-19.

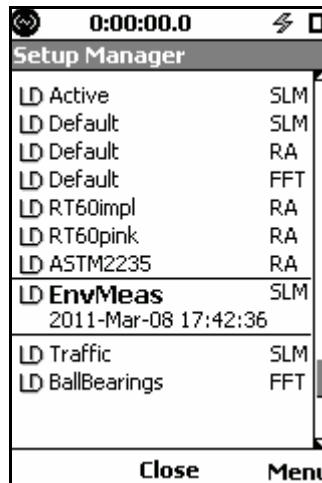

FIGURE 4-19 User-Defined Setup Made Active

Modifying the Active Setup

When working with the Setup Manager, to modify the active setup, highlight the setup **LD Active** and press the right software button labeled **Menu** to bring up the display shown in FIGURE 4-20.



FIGURE 4-20 Modify Active Setup Menu

Highlight **Edit** and press **ENTER** to bring up the Setup Screen, as shown in FIGURE 4-21

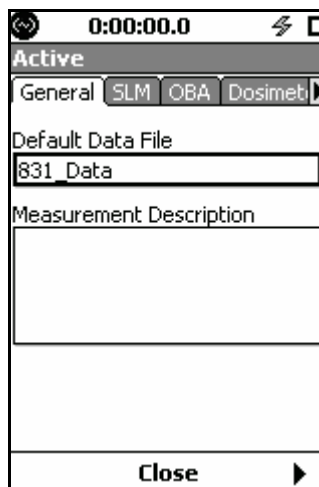

FIGURE 4-21 Setup Screen

Use this setup screen to make all desired modifications to the Active setup. When done, press the softkey labeled **Close**, which will open the menu shown in FIGURE 4-22

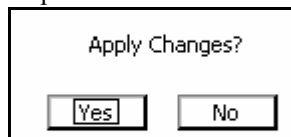

FIGURE 4-22 Apply Changes to Active Setup

Note: If the present Active setup has been derived from a user-defined setup, as described in “Utilizing a User-Defined Setup” on page -19, applying changes will implement the same changes in the original user-defined setup file.

Save Modified Setup

Define Name

The name must contain no more than eight characters and spaces cannot be used as delimiters.

It is much easier to specify setup names when using the SLM Utility-G3 or G4 software.

Select **Yes** to accept the changes, or **No** to cancel the operation.

To save the modified setup, press the right softkey labeled **Menu** to obtain the display shown above in FIGURE 4-20.

Highlight **Save As** and press **ENTER** to obtain the display shown in FIGURE 4-23.

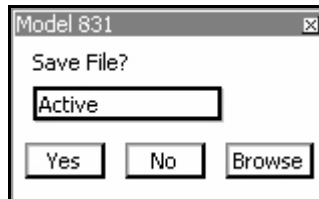

FIGURE 4-23 Save File Menu

Highlight the name field, presently showing “Active” and press **ENTER** to modify it. This will produce a cursor as shown in FIGURE 4-24

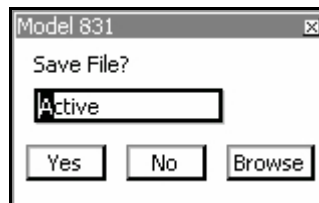

FIGURE 4-24 Save File Menu: Cursor Active

Enter the name and press **ENTER** to accept the name. Highlight the **Yes** box and press **ENTER** to save the setup under that name. To cancel the save operation, highlight **No** and press **ENTER**.

Overwrite an Existing Setup File

If, rather than use a new name you wish to use the modified Active setup file to replace an existing setup file, instead of pressing the **Yes** box shown in FIGURE 4-24, highlight the box labeled **Browse** and press **ENTER**. This will open a display listing all the user-defined files as shown in FIGURE 4-25.



FIGURE 4-25 User-Defined Setup Files

Highlight the name of the setup file to overwrite and press **ENTER**. The Save File menu will now appear with the name of that file in the name field, as shown in FIGURE 4-26



FIGURE 4-26 Overwrite File Menu

To complete the overwrite operation, highlight **Yes** and press **ENTER**. To cancel the overwrite operation, highlight **No** and press **ENTER**. To select a different file name, highlight the box labeled **...** and press **ENTER** to repeat the file selection process.

User-Defined Setup File Operations

A number of operations can be performed using the user-defined setup files by highlighting any one and pressing **ENTER** to obtain the display shown in

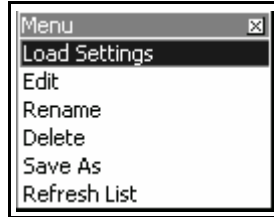

FIGURE 4-27 User-Defined File Operations

Highlight the desired operation and press **ENTER** to implement it.

Load Settings

Load Settings loads the settings from the selected file into the Model 831.

Edit

Edit permits the user to modify the settings in the selected file, in the same manner as used for modifying the Active setup, described in “Modifying the Active Setup” on page 4-20.

Rename

The name must contain no more than twelve characters and that a space cannot be used as a delimiter.

Rename permits the user to define a new name for the selected file. The menu shown in FIGURE 4-28 will appear to implement the renaming process.

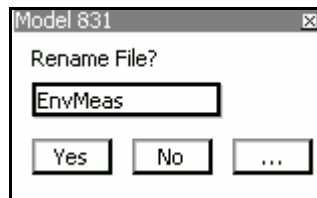

FIGURE 4-28 Rename Setup File

Work with this menu as you would for the Save File menu, described in “Save Modified Setup” on page 4-21.

Delete

Delete permits the deletion of the selected file. A confirmation display will appear as shown in FIGURE 4-29.

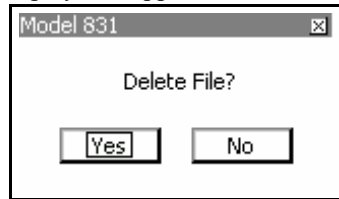

FIGURE 4-29 Delete Setup File

Save As

Note that the name must contain no more than twelve characters and that a space cannot be used as a delimiter.

Save As permits the selected to be saved under a different name, or to overwrite an existing user-defined file. Follow the procedure described in “Save Modified Setup” on page 4-21.

Refresh List

Refresh List updates the setup list in the Setup Manager display.

Close Setup Manager

Press the center softkey labeled **Close** to close the Setup Manager.

Data Display

In the previous chapter, the setup procedure for a basic sound level measurement was described. This chapter describes how this data would be displayed during or following a measurement sequence.

The Model 831 can measure many additional sound parameters simultaneously with these basic sound measurements as described in other sections of this manual. It can also measure a variety of non-acoustical parameters, as described in Chapter 19 "Non-Acoustical Inputs" on page 19-1 and the section "Non-Acoustical Metrics" on page 11-3.

Data Labels

The labels for sound metrics in the Model 831 are designated by international standards. For many displayed values, the frequency and time weighting are indicated in the name of the metric. Example: L_{AS} is the A-weighted sound pressure level measured using the Slow detector. Sound pressure level is often referred to as SPL.

Tabbed Structure

Only a few of these horizontally arranged tabs (three in Figure 5-1) can be seen at one time. To see those off-screen to the right use the Right Softkey beneath the display. To scroll back to the left, use the Left Softkey beneath the display.

Measured data are displayed using a number of tabs arranged horizontally across the screen, as shown in Figure 5-1. Depending on the firmware options loaded in the Model 831, there may be as many as seven different data display tabs each identified by a title at the top. Use the Right and Left Softkeys to navigate between tabs.

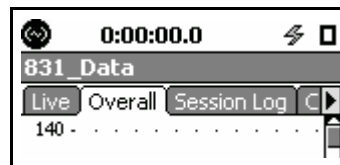



FIGURE 5-1 Tabbed Structure



Live Tab

The Live tab may not appear as described here if the displays have been customized. For a detailed description of display customization, see the section "Displays" on page 18-23

You can also access the Any Level Display, from any tab, as described in "Any Level Display" on page 5-41.

SLM Display

When the Model 831 is turned ON, the user is generally presented with the **Live** tab. The measurements displayed on the **Live** tab are always active, real-time measurements. The displayed values are not controlled by the  (RUN/PAUSE) key. This allows you to view the current SPL without disrupting any overall data. For example, suppose you are making a measurement and an unwanted event takes place, causing you to stop the measurement. With the measurement stopped, you can monitor the actual level on the **Live** tab to be certain that the residue effects of the unwanted event have died down before beginning a new measurement.

The **Live** tab includes multiple pages for displaying data. Use the  (UP) or  (DOWN) keys to navigate up or down through pages on the tabs.

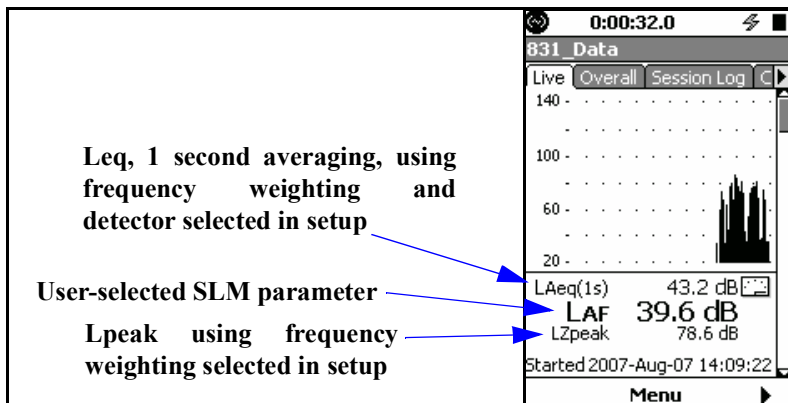

FIGURE 5-2 Live Tab: Sound Level Profile

The Profile page presents a recent history of L_{eq} calculated for each second. The graph presents the last 120 seconds of the measurement.

The first numerical level displayed, $L_{Aeq(1s)}$ in this example, is the most recently graphed 1 second value. The frequency

weighting, and possibly the detector, will correspond to those selected in setup for the RMS value.

The 2nd numerical level display, L_{AS} in this example, corresponds to a user-selected parameter. The default value is L_{AS} . The selection of this value is described in "User-Selected SLM Parameter" on page 5-3.

The 3rd numerical level displayed, L_{Zpeak} in this example, is the current measurement from the 1 s. peak detector. The frequency weighting will correspond to that selected in setup for the peak value.

The time at the bottom of the page is the date and time the measurement was started.

User-Selected SLM Parameter

To select which sound level parameter is to be utilized for the 2nd numerical value displayed, press **ENTER** to open the menu shown in FIGURE 5-3

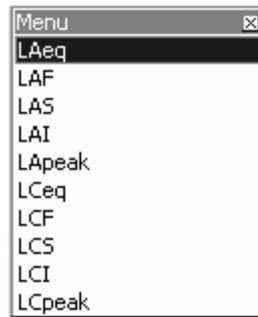

FIGURE 5-3 Menu for User-Selected SLM Parameter

Highlight the desired parameter and press **ENTER** to make the selection.

Large Digit Sound Level

The large digit display is provided to make it easier for the user to observe both the instantaneous sound level and along with the value of the user-selected SPL1 Trigger Level.

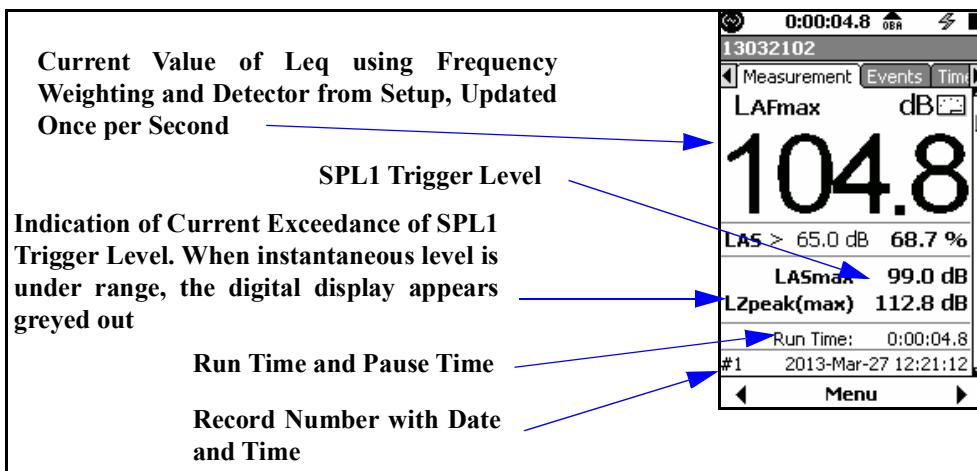

FIGURE 5-4 Live Tab, Large Digit

In addition to displaying the current value of Leq, this display uses a check mark to indicate a current exceedance of the SPL1 trigger level.

1/1 Octave Band Analyzer (Optional)

The 1/1 Octave Band Analyzer display appears only when the instrument is loaded with the optional 831-OB3 firmware.

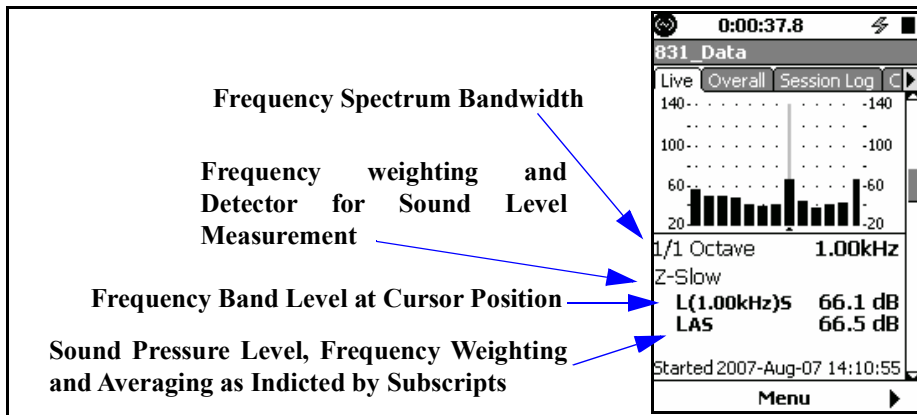

FIGURE 5-5 Live Tab: 1/1 Octave Spectrum

The 1/1 Octave page shows a bar graph of sound level in 1/1 octave frequency bands. The right most bar on the graph is the L_{AS}.

Note that the spectrum frequency weighting is selected independently from that of the sound level measurement, as described in "OBA Frequency Weighting" on page 4-7. The detector is the same as that of the sound level measurement.

It is indicated beneath the graph that it is in 1/1 octave bands. On the graph, the vertical bar for the selected octave band is highlighted. The frequency of the octave band for which data is being displayed, the sound pressure level frequency weighting (A weight) and the detector response (Slow) are also shown.

Note that the graph scaling can be modified as described in section "Adjust Graph Scale" on page 5-29 and the display normalized to another spectrum, as described in section "View Spectrum Normalized" on page 5-30.

L_{(1.00kHz)S} indicates the sound level in the 1 kHz band with a Slow detector setting.

L_{AS} is the A weighted, Slow detector response sound level.

Cursor

Use the $\left\{ \right\}$ and $\left\} \right\}$ keys to move the cursor left and right, respectively.

1/3 Octave Band Analyzer (Optional)

The 1/3 Octave Band Analyzer display appears only when the instrument is loaded with the optional 831-OB3 firmware.

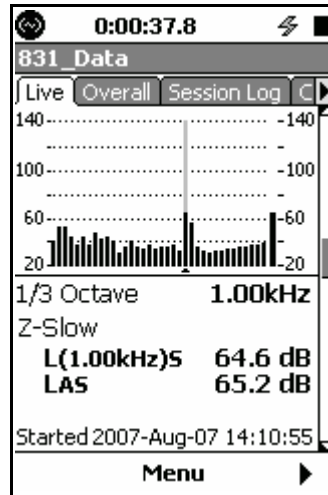

FIGURE 5-6 Live Tab: 1/3 Octave Spectrum

Note that the graph scaling can be modified as described in section "Adjust Graph Scale" on page 5-29 and the display normalized to another spectrum, as described in section "View Spectrum Normalized" on page 5-30.

The 1/3 Octave page is similar to FIGURE 5-5. The graph and data are presented for 1/3 octave bands.

Triggering

For a detailed description of triggering, see "Triggers Tab" on page 4-11.

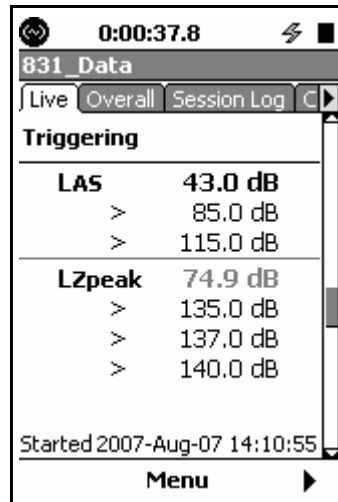

FIGURE 5-7 Live Tab: Triggering

The **Triggering** page displays the instantaneous sound level and instantaneous peak level with their associated trigger points. Exceedances of these trigger points will be indicated by a check mark appearing to the right of each. The check mark will appear only as long as the measured level remains above the trigger point.

Preamp Display

The purpose of the Preamp Display is to validate proper operation of the system. It shows information regarding the preamplifier currently connected; specifically the preamplifier type, the SPL and DC voltage at the input to the Model 831 (for diagnostic purposes).

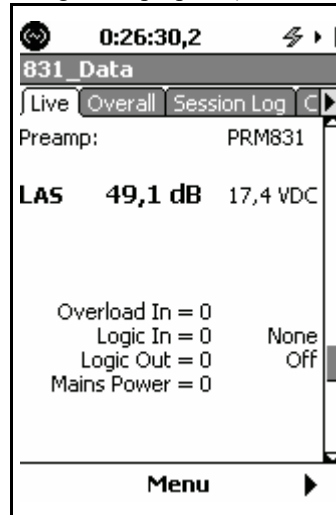

FIGURE 5-8 Live Tab: Preamp

Using 426A12

The information provided by the Preamp Display is particularly important when used with the 831-INT System Interface Unit and the 426A12 Outdoor Preamplifier and Power Supply. It shows information regarding the control signals of the control port that connects the 831-INT; specifically the Overload logic input (indicates a hardware detected overload condition in the 426A12), the logic input state, the logic output state, the settings regarding the logic in and out line, and the status of the Mains Power logic input (indicates the status of mains power to the 831-INT).

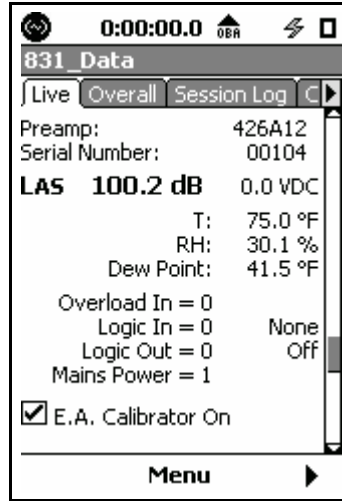

FIGURE 5-9 426A12 Preamp, E.A. On

In FIGURE 5-9 we see the display includes the serial number and the current internal temperature, humidity and dew point. The temperature, humidity and dew point metrics permit desiccant maintenance information to be gathered regularly and stored with the data. This can also be done remotely without having to perform an in-field service call.

The electrostatic actuator can be activated when stopped by pressing **ENTER** to toggle the E.A. calibrator On and Off. The SPL displays the measured E.A. level.

Using ICP Preamplifier

When using an ICP power preamplifier, additional information can be displayed as shown in FIGURE 5-10

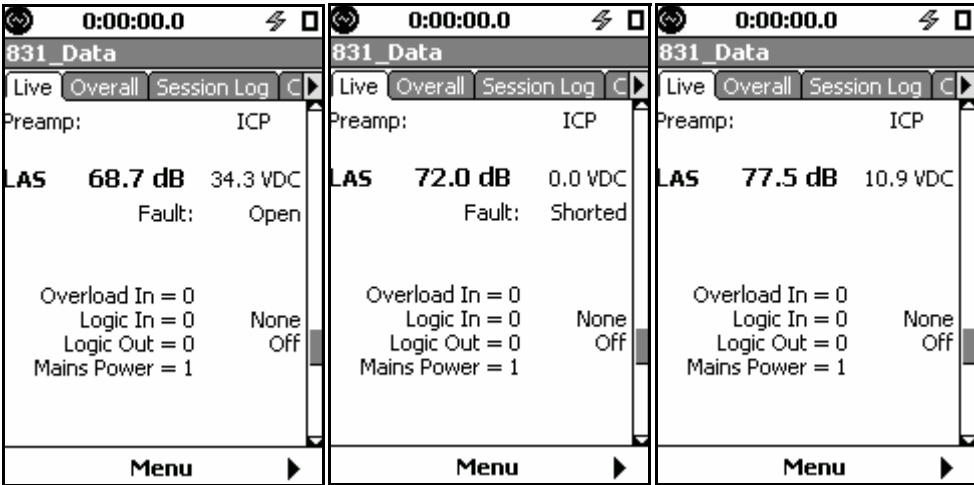

FIGURE 5-10 ICP Preamp Displays

Here we can see how the DC voltage measured at the input of the Model 831 is useful in diagnosing problems with the input signal. The **Fault:Open** indicator is shown if the voltage is too high (34.3 Vdc) and the **Fault:Shorted** indicator is shown if the voltage is too low (0.0 Vdc). The nominal voltage (10.9 Vdc) when there is no fault is also helpful in verifying that the unit is biased properly and that the maximum signal excursion is possible.

Time, Battery Voltage and Memory



FIGURE 5-11 Live Tab: Time, Battery, Memory

This page indicates the current date and time, the run time for the measurement, battery voltage, calculated run time and memory usage.

Battery



Note that it takes approximately one minute to obtain an accurate measure of battery parameters. During this time, the display will indicate --.

When running on battery power, this will indicate the battery voltage and remaining time instrument will operate.

Memory

The Memory section indicates the amount of memory available as a percentage and in number of kBytes. The number of stored data files is also indicated.

Overall Tab

The **Overall** tab includes multiple pages. Use the  or  keys to navigate up or down through pages on the tabs.

Note that from any of the displays described in this section, the user can also access the Any Level Display, described in "Any Level Display" on page 5-41.

This section addresses only those sections of the **Overall** tab associated with basic sound level measurements. Other tabs associated with data provided by optional firmware may also appear. Although the 1/1 and 1/3 octave spectra require optional firmware (831-OB3), we do include the display of this data in this chapter.

Leq

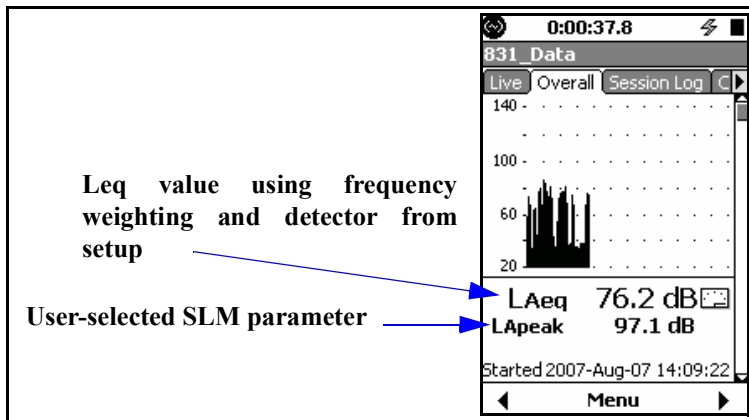

FIGURE 5-12 Overall Tab: Sound Level Profile

From this display the user can also access the Any Level Display, described in "Any Level Display" on page 5-41.

The graph on this page depicts the profile of sound levels measured throughout the overall measurement. The left side of the graph is the very beginning and the right side is the very end of the overall measurement. The run time for the average calculation is shown at the top of the screen. The graph display is updated approximately four times per second.

The 1st numerical value displayed, L_{Aeq} in this example, is the equivalent sound level based on the run time of the measurement. The frequency weighting and detector correspond to those used in the setup.

The 2nd numerical value displayed is L_{Apeak} in this example, is a user-selected value. The selection of this value is described in “User-Selected SLM Parameter” below.

The time at the bottom of the page is the date and time the measurement was started.

User-Selected SLM Parameter

To select which sound level parameter is to be utilized for the 2nd numerical value displayed, press **ENTER** to open the menu shown in FIGURE 5-13

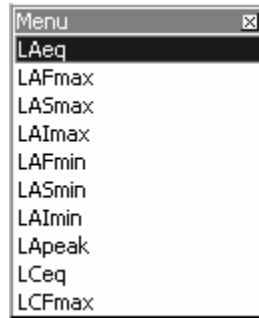

FIGURE 5-13 Menu for User-Selected SLM Parameter

There are twenty-four possible selections; scroll down to see more than shown in FIGURE 5-13.

Highlight the desired parameter and press **ENTER** to make the selection.

Overall Large Digit Sound Level

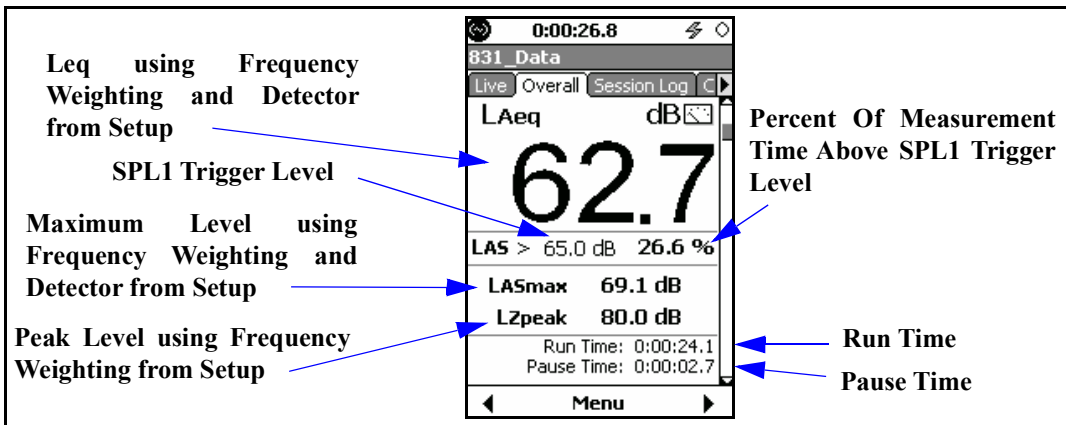

FIGURE 5-14 Overall Tab: Large Digit Display

The graph scaling can be modified as described in section "Adjust Graph Scale" on page 5-29.

This page presents a data-compressed profile of the sound level for the run time of the measurement. The large digit display is updated along with the calculation of the average sound level approximately four times per second. The process is continuous throughout the run time. The Pause Time indicator shows the amount of time the current measurement was paused.

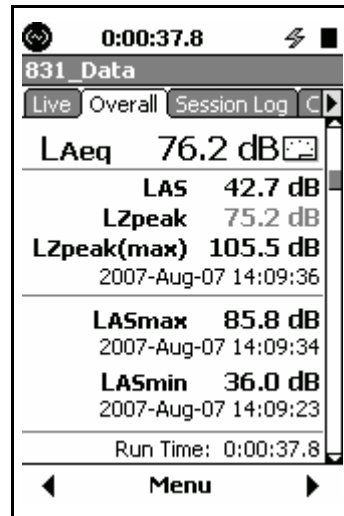



FIGURE 5-15 Overall Tab: Overall SLM

L_{AS} represents the live sound pressure level for the active frequency and time weightings and the L_{Zpeak} represents the live instantaneousness peak level. They are displayed here to allow the user to see these live metrics and their effect on the overall maximum, minimum and equivalent levels.

L_{ASeq} and the L_{AS} are also shown on this page of the **Overall** tab.

The L_{Zpeak} (Z frequency weighting) is the live reading of the peak detector.

The L_{Zpeak(max)} is the highest level the peak detector has measured during the run time of the measurement. A date and time of occurrence is recorded with this event.

The L_{Zpeak(max)} is also considered the peak hold. Whenever data is reset, this parameter is cleared. To reset data, press the  (RESET) key.

The L_{ASmax} is the highest level the SPL detector has measured during the run time of the measurement. A date and time of occurrence is recorded with this event.

The L_{ASmax} is also considered the max hold. Whenever data is reset, this parameter is cleared. To reset data, press the  key.

The L_{ASmin} is the lowest level the SPL detector has measured during the run time of the measurement. A date and time of occurrence is recorded with this event.

1/1 Octave Band Analyzer (Optional)

The 1/1 Octave Band Analyzer display appears only when the optional firmware 831-OB3 has been enabled and this measurement mode has been selected in the setup.

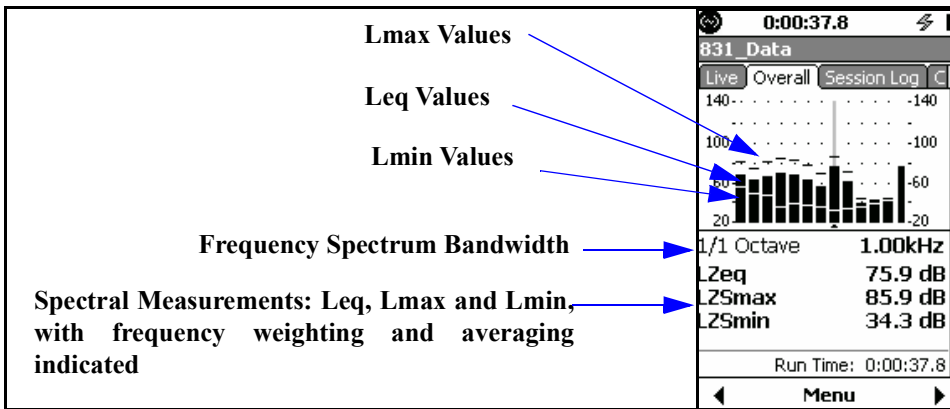

FIGURE 5-16 Overall Tab: 1/1 Octave Spectrum

Note that the graph scaling can be modified as described in section "Adjust Graph Scale" on page 5-29 and the display normalized to another spectrum, as described in section "View Spectrum Normalized" on page 5-30.

Leq

The data displayed in section four shows Leq, Lmax and Lmin sound levels in 1/1 octave frequency bands calculated for the duration of the measurement. The right most bar on the graph is the sum of the Leq values for the total spectrum.

The bar for the displayed frequency band is highlighted. The highlight can be moved using the \leftarrow and \rightarrow keys.

L_{eq} is the energy average sound level of the highlighted frequency band for the duration of the measurement.

Lmin

L_{min} is the minimum sound level of the highlighted frequency band for the duration of the measurement. Since individual frequency bands may reach their minimum levels at different times, this spectrum might be one which never occurred at any instant during the measurement period.

Lmax

Lmax is the maximum sound level of the highlighted frequency band. The maximum spectrum is determined by the Max Spec setting.

Bin Max

When set to **Bin Max**, it is the maximum value which occurred during the entire measurement for that frequency band. Since individual frequency bands may reach their maximum levels at different times, this spectrum might be one which never occurred at any instant during the measurement period.

At Max

When set to **At Lmax**, it is the instantaneous spectrum at the moment when the broadband maximum occurred (such as L_{ASmax}).

1/3 Octave Band Analyzer (Optional)

The 1/3 Octave Band Analyzer display appears only when the instrument is loaded with the optional 831-OB3 firmware and this measurement mode has been selected in the setup.

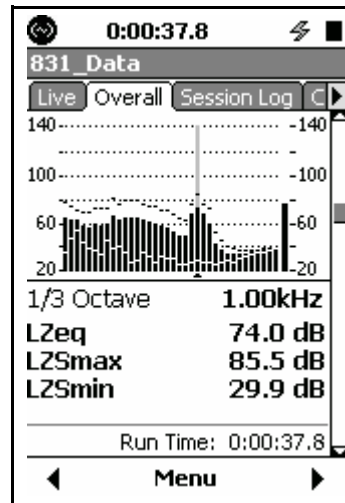
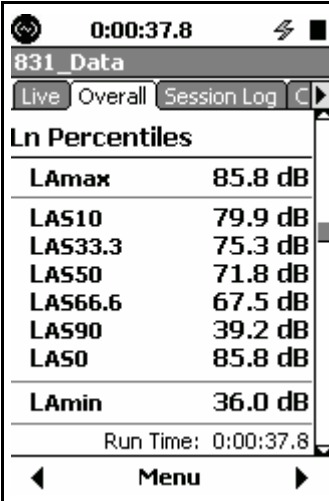

FIGURE 5-17 Overall Tab: 1/3 Octave Spectrum

Note that the graph scaling can be modified as described in section "Adjust Graph Scale" on page 5-29 and the display normalized to another spectrum, as described in section "View Spectrum Normalized" on page 5-30.

The data displayed on this page is similar to that displayed for a 1/1 octave spectrum measurement, described in "1/1 Octave Band Analyzer (Optional)" on page 5-16, except that it represents 1/3 octave data.

Ln Percentiles



The screenshot shows a handheld device interface for the 831 Data Overall Tab. At the top, there is a status bar with a signal strength icon, a timer at 0:00:37.8, and a battery icon. Below this is a header bar with '831 Data' and a 'Live' button. A navigation bar contains 'Overall', 'Session Log', and a right arrow. The main content area is titled 'Ln Percentiles' and contains a table of sound level statistics. At the bottom, there is a 'Run Time: 0:00:37.8' and a 'Menu' button with left and right arrows.

Ln Percentiles	
L _{Amax}	85.8 dB
L _{A510}	79.9 dB
L _{A533.3}	75.3 dB
L _{A550}	71.8 dB
L _{A566.6}	67.5 dB
L _{A590}	39.2 dB
L _{AS0}	85.8 dB
L _{Amin}	36.0 dB

Run Time: 0:00:37.8

FIGURE 5-18 Overall Tab: Ln Percentiles

The **Ln Percentiles** page displays the Ln statistics for the measurement based on the run time. Also shown are the maximum and minimum sound levels measured. An Ln is the level that was exceeded "n" percent of the time.

The values of Ln are calculated from an amplitude distribution table, ranging from 0 to 200 dB, in 0.1 dB steps. As a result, it is possible to calculate Ln values from values of n ranging from 00.01% to 99.99%. The values shown in FIGURE 5-18 represent the six values which were selected for display during setup. At any time during a measurement, any or all of these Ln values can be changed, as described in "Modifying Ln Values During a Measurement" on page 4-8, so that Ln values corresponding to different values of n may be displayed.

NF30-101 Ln (Optional)

The NF30-101 Ln display appears only when both the 1/3 octave OBA bandwidth and NF30-101 firmware options have been enabled.

The NF30-101 option computes the broadband Ln table values from an energy sum of the 1/3 octave from 25 Hz to 2 kHz filters. This method of computing Ln values is used primarily in France. Figure 5-19 shows the Ln percentiles with the NF30-101 option enabled.

Ln Percentiles 25-2k Hz	
LASmax	70.3 dB
LNF5	69.0 dB
LNF10	68.4 dB
LNF33.3	37.7 dB
LNF50	37.6 dB
LNF66.6	37.5 dB
LNF90	37.4 dB
LASmin	12.0 dB

Run Time: 0:10:00.0

FIGURE 5-19 Ln with NF30-101

Spectral Ln (Optional)

The Spectral Ln display appears only when the optional 831-OB3 firmware has been enabled and the Spectral Ln Mode set for 1/1 or 1/3 octave measurements, as described in "Spectral Ln Mode" on page 4-7.

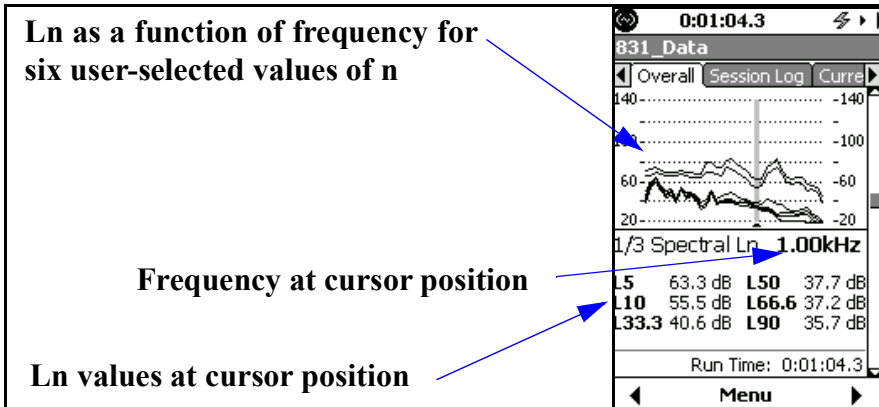

FIGURE 5-20 Overall Tab: Spectral Ln

The graph shown in FIGURE 5-20 overlays curves of Ln as a function of frequency for the six values of n defined in the setup, as described in "Ln Tab" on page 4-7. These are the same n values used in the display of overall Ln in "Overall Tab: Ln Percentiles" on page 5-18.

Note that the graph scaling can be modified as described in section "Adjust Graph Scale" on page 5-29.

Numerical values of Ln for the six user-selected values of n at the frequency corresponding to the cursor position are displayed as indicated in FIGURE 5-20. Use the $\left\{ \right\}$ and $\left\} \right\}$ keys to move the cursor left and right, respectively, along the frequency axis.

See "Spectral Statistics" on page 24-5 for a more detailed description of spectral Ln measurements.

Exceedances

For a detailed description of noise events based on threshold exceedances, see "Triggers Tab" on page 4-11.

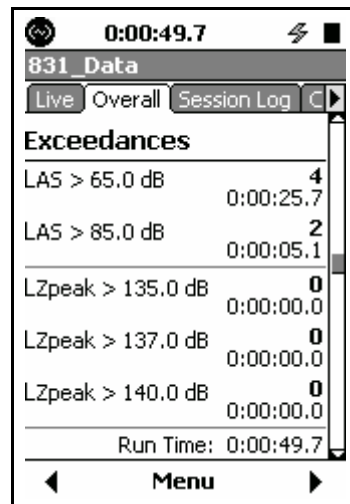

FIGURE 5-21 Overall Tab: Exceedances

The **Exceedances** page shows the number of exceedances that have occurred during the measurement and the total duration of exceedances. Exceedances are shown for two threshold levels of the SPL detector and three for the peak detector.

Overloads

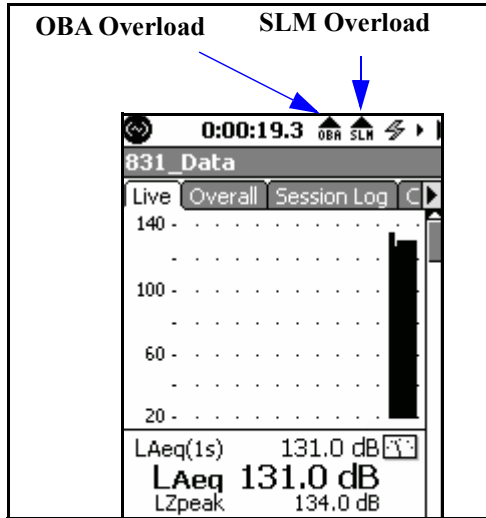

FIGURE 5-22 Overall Tab: Overloads

The Overloads page shows the number of times, the percent of time and the amount of time that the Sound Level Meter and the OBA have been overloaded.

The Community Noise page is shown in Figure 5-23.

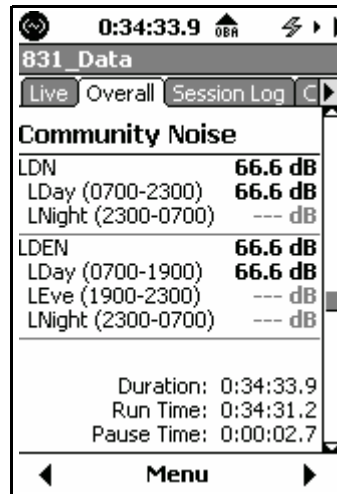

FIGURE 5-23 Overall Tab: Community Noise

Since community noise metrics are based upon full day measurements, they do not present valid data for measurements less than 24 hours duration.

The **Community Noise** page displays the parameters L_{DN} , L_{DEN} , L_{Ceq} and L_{Aeq} , commonly used to evaluate community noise, and $L_{Ceq}-L_{Aeq}$, used to describe the low frequency content of a sound and also as a parameter in the selection of hearing protection devices. The parameter L_{AFTM5} will appear when “Takt Maximal Data” has been selected on the Preferences Page as shown in "Takt Maximal Data" on page 18-14. The definition is shown in "Taktmaximal-5" on page D-21.

L_{DEN}

Although the standard ISO 1996-2:2007 specifies default values for the parameters used in the calculation of L_{DEN} , in practice the time values defining the day, evening and night periods may be changed, as permitted by Directive 2002/49/EC of the European Parliament and of the Council of 25 June 2002 relating to the assessment and management of environmental noise. It is important to verify prior to measurement that the parameters have been properly defined for your purposes. See Chapter 4 "Day/Night Tab" on page 4-13 for a detailed description of the setup procedure.

C-A and Impulsivity

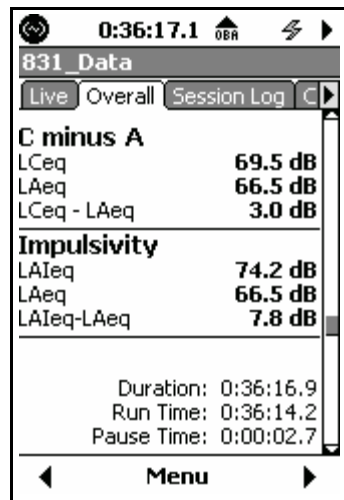

FIGURE 5-24 Overall Tab: C-A Level and Impulsivity

The “C minus A” metric provides an indication of the low frequency content of noise measured by subtracting the A-

weighted equivalent level from the C-weighted equivalent level.

The integrated levels for L_{Aeq} are always calculated using the linear detector, regardless of the value selected in the SLM Setup. The L_{Aeq} value is from the impulse detector.

Industrial Hygiene

If the optional Industrial Hygiene firmware is enabled, a display for sound exposure, two displays for noise dose and a display for SEA will appear between the Community Noise and the Number of Measurement screens. These are discussed in Chapter 9 "Industrial Hygiene" on page 9-1.

Status Page



FIGURE 5-25 Overall Tab: Number of Measurements

The Status page on the **Overall** tab displays the number of session log entries, the quantity of each type of measurement which has been made, the number of sound recording made and also the memory status for the current measurement session.

The number of sound recordings includes the following:

- **Manually Initiated Recordings**
- **Marker Initiated Recordings**

- Event Recordings
- Measurement Recordings

Session Log Tab

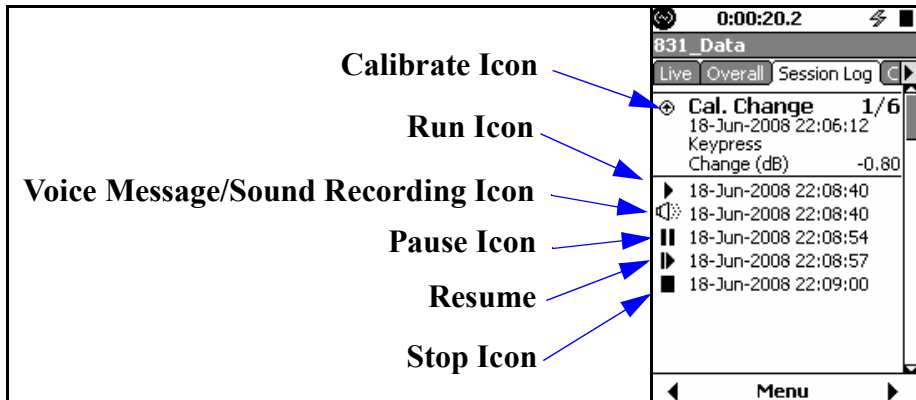

FIGURE 5-26 Session Log Tab

The Session Log is a record of data accumulation actions. Resetting and storing data will clear the session record.

A time-stamped record is made for every Calibrate, Run, Pause, Resume, Stop, Voice Message and Sound Recording etc. action. The source responsible for each action is also recorded which may be any of the following:

- **Key press**
- **Measurement (Sound Recording)**
- **Event (Sound Recording)**
- **Marker (Sound Recording)**
- **USB command**
- **Run timer complete**
- **Analog Modem (Communication Failure)**
- **831 INT-ET (Communication Failure)**
- **GPS Time Sync**
- **Low battery**
- **Out of memory**
- **Preamplifier disconnect**

The Measurement Status Icons are described in "Measurement Status" on page 3-10.

The icons in the left column of the display indicate the action: Run, Pause, Voice Recording, etc. The date and time of the action is displayed next to the icon.

Each measurement segment (from Run to Stop) is numbered, as is each voice message and sound recording.

The user may scroll the list and expand each item. In the upper right corner of the expanded item the number indicates which item is being viewed out of how many total items are in the list.

GPS Time Sync

The GPS Time Sync icon and the time sync data are shown in FIGURE 5-27.

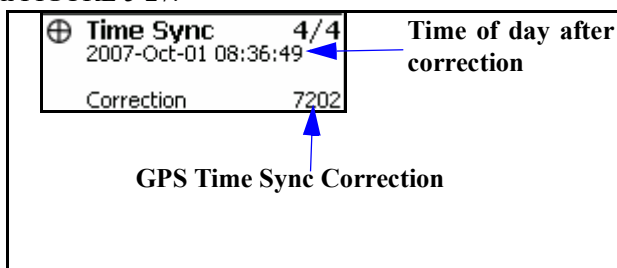

FIGURE 5-27 GPS Time Sync

The correction is the number of seconds that the internal clock was adjusted. A negative number represents the clock being set backwards in time. For further detail on the setup of a GPS device, see "Location Measurement Using 831-INT" on page 19-10.

FIGURE 5-28 presents a list of all actions and the valid causes for each of them.

Action	Cause												
	Key Press	I/O Command	Timer	Power	Out-of-Memory	Preamplifier Disconnected	Stable Level	Marker	GPS	Event	Measurement	831-INT-ET	Analog Modem
Run	√	√	√										
Stop	√	√	√	√	√		√						
Pause	√		√			√							
Resume from Pause	√		√										
Voice Message	√												
Sound Recording	√							√		√	√		
Calibration Check	√		√										
Time Synchronized									√				
Marker (1 to 10)		√											
Watchdog												√	√

FIGURE 5-28 Session Log Actions and Causes

Voice Message/Sound Recording Playback

Note that voice messages, which are recorded using the Voice Recorder Page of the Control Panel, can also be played back from there. For more detail, see Chapter 10 "Voice Recording" on page 10-1. There are a number of alternative ways to playback sound recordings. See "Sound Recording Playback" on page 16-20 for more detail.

Voice messages and sound recordings can be played back from the **Session Log** tab. Highlight the desired voice message or sound recording, indicated by the Voice Message/Sound Recording Icon shown in FIGURE 5-26 "Session Log Tab" on page 5-25. A highlighted voice

message or sound recording will appear as shown in FIGURE 5-29.

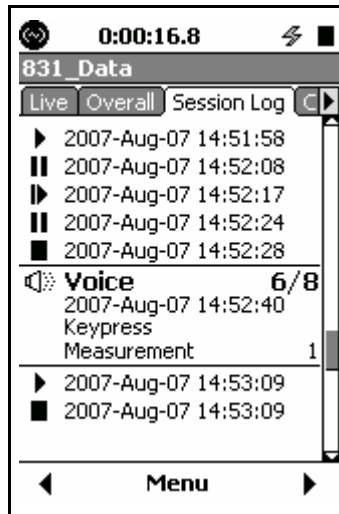

FIGURE 5-29 Highlighted Voice Message, Session Log

To play back the highlighted voice message, press **ENTER** or select the Play menu item, shown in FIGURE 5-30.

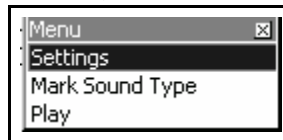

FIGURE 5-30 Voice Recording Play Menu

Adjust Graph Scale

The default amplitude (dB) settings for the graphic display of sound pressure level versus time and frequency spectra (1/1 and 1/3 octave) are as indicated below:

- **Level vs Time Graph:** 20 dB to 140 dB
- **Frequency Spectra Graph, Normal Range:** 20 dB to 140 dB
- **Frequency Spectra Graph, Low Range:** -10 dB to 110 dB

To change the scaling of any one of these graphs, press the Menu softkey to obtain the display shown in FIGURE 5-31.

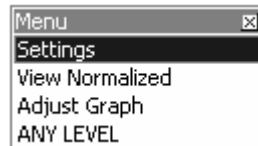



FIGURE 5-31 Menu

Use the  key to highlight **Adjust Graph** and press  to obtain the Adjust Graph menu shown in FIGURE 5-32

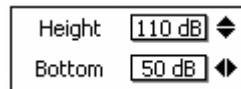







FIGURE 5-32 Adjust Graph Menu

Note that when the OBA Range for frequency spectra has been set to Low, the value actually used for the baseline of the display will be 30 dB less than the number indicated for Bottom in the Adjust Graph menu.

Use the  and  keys to change the baseline level and the  and  keys to adjust the height (range between the baseline and the top of the display). Press  to implement the change.

Once one or more graphic displays have had their scaling changed, they will remain that way until changed again or until the defaults settings are restored, as described in "Format & Restore Defaults" on page 23-3.

View Spectrum Normalized

Note that the Live Spectrum will continue to change in time following the normalization, whereas the Reference spectrum will remain the same.

The default 1/1 and 1/3 octave spectrum displays present the amplitude versus frequency of the measured spectrum as shown in FIGURE 5-5 and FIGURE 5-6.

The View Normalized function permits the display of the difference between two spectra by subtracting a user-selected reference spectrum from the measured spectrum. This function can be used with both 1/1 and 1/3 octave spectra, although the measured spectrum and the reference spectrum must have the same bandwidth; 1/1 or 1/3 octave.

A and C frequency weighting curves can also be used for the reference, as described in "Normalizing using Frequency Weighting" on page 5-34.

Live Display

A standard spectrum displayed on the Live tab appears as shown in FIGURE 5-33.

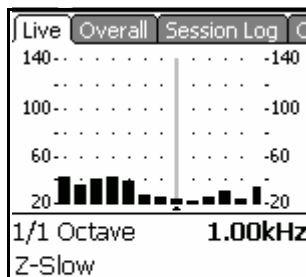

FIGURE 5-33 Standard Live Spectrum Display

To access the View Normalized display, press the center software Menu to display the menu shown in FIGURE 5-34.

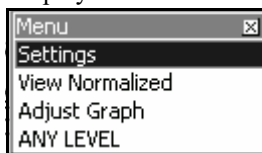

FIGURE 5-34 Menu

Highlight **View Normalized** and press **ENTER** to make the selection. This will display the spectrum in the normalized view, as shown in FIGURE 5-35.

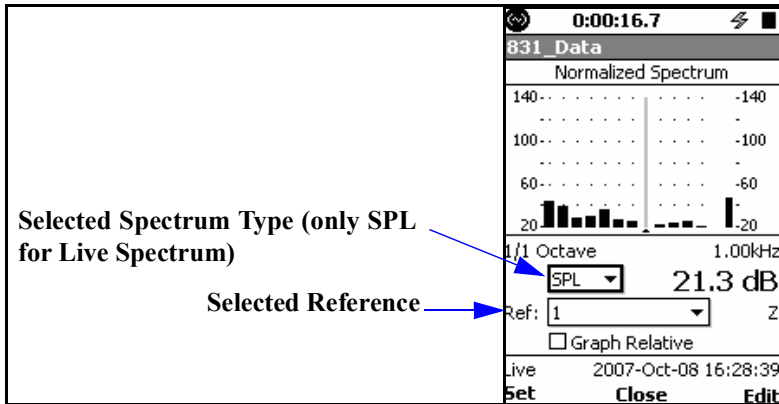

FIGURE 5-35 Normalized Live Spectrum Display: No Reference Selected

Since a reference spectrum has not yet been defined, the spectrum shown will be the same as the Live Spectrum. If it does not, there has probably been a reference spectrum defined previously.

Selecting the Spectrum Type

Since only the SPL spectrum is displayed in the Live Spectrum view, it is not necessary to select a spectrum type since only SPL will appear if that menu is opened.

Selecting the Reference Spectrum

Highlight the **Ref:** data field and press **ENTER** to open the Reference Menu, shown in FIGURE 5-36.

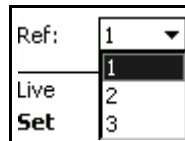



FIGURE 5-36 View Normalized Reference Menu

The items listed in this menu are as follows:

- **1**
- **2**
- **3**
- **4**
- **A**
- **C**
- **-A**
- **-C**

The first four items permit the user to define four reference spectra based on the spectrum being displayed. Since the Live spectrum only displays SPL, there is little need for multiple reference spectra.

The last four items permit the user to use positive or negative A or C frequency weightings as reference spectra. See "Normalizing using Frequency Weighting" on page 5-34.

Highlight the desired reference spectrum and press  to make a selection.

Once the reference spectrum has been selected, press the left softkey **SET** to display the Live Spectrum in the normalized view.

Normalized Using The Measured Spectrum

When the displayed spectrum has been normalized using the measured spectrum, and the sound being measured is not much different than it was previously, the display will resemble FIGURE 5-37.

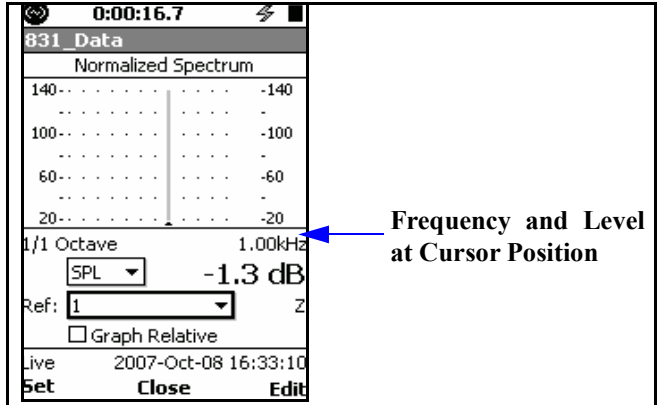
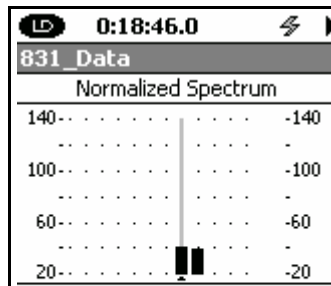

**FIGURE 5-37 Normalized Spectrum Display:
Similar Sound Field**

The display scaling can be adjusted to show lower level and negative values as described in "Adjusting Graph Display" on page 5-34.

We can see that at 1 kHz, the cursor position, the measured level is 1.3 dB above that of the reference spectrum, but this is not visible on this graph because the bottom of the scale is ~ 20 dB.

If the display were more like that shown in FIGURE 5-38, this would indicate that the levels in the 1 kHz and 2 kHz bands were approximately 42 dB higher than for the reference spectrum.



**FIGURE 5-38 Normalized Spectrum Display:
Higher Levels at 1 kHz and 2 kHz**

Adjusting Graph Display

Because some of the frequency components in the normalized view may be small or negative, the Adjust Graph function described in "Adjust Graph Scale" on page 5-29 can be used to obtain a graph having both positive and negative amplitude values. The Adjust Graph function can only be implemented from the source graph, so in this case return to the Live spectrum display, adjust the graph as desired, then return to the normalized view for which the same adjustment will be in effect.

Normalizing using Frequency Weighting

When normalizing using positively signed A and C, this normalization subtracts a spectrum which is the inverse of the spectrum representing the corrections. Thus, by selecting A (or C), this will negate the frequency weighting effect on spectra which had originally been measured using A (or C) frequency weighting. To obtain an A (or C) weighted spectrum when the measurement had been made without frequency weighting, select -A (or -C) for the reference. For example, when the measured spectrum is similar to FIGURE 5-33, by selecting -A the normalized view displays an A-weighted version of this spectrum, as shown in FIGURE 5-39.

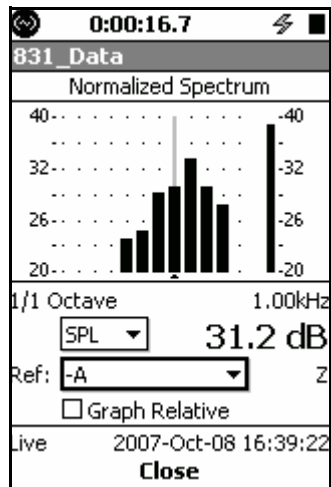

FIGURE 5-39 Spectrum From

Note that the scale in FIGURE 5-39 was adjusted as described in "Adjusting Graph Display" on page 5-34 in order to display the low level and negative amplitudes.

Normalizing using User-Defined Spectrum

The user can also define their own reference spectrum by pressing the Edit softkey as shown in FIGURE 5-40.

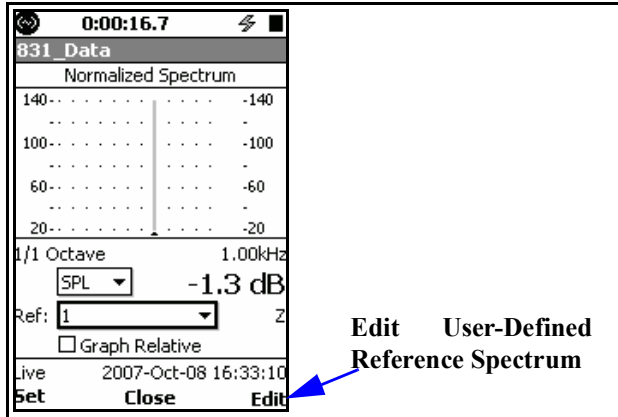

FIGURE 5-40 Edit Softkey for User-Defined Reference Spectrum

This will produce the display shown in FIGURE 5-41.

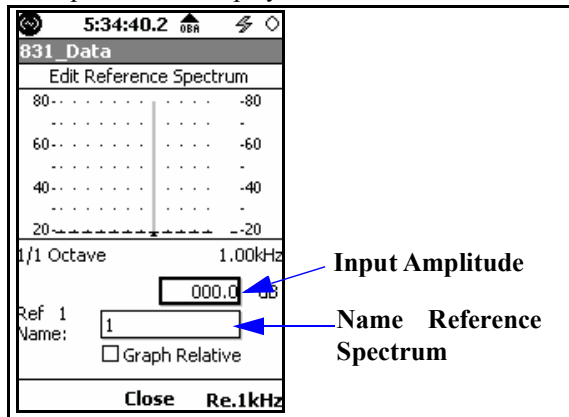

FIGURE 5-41 Creating User-Defined Reference Spectrum

Creating a User-Defined Reference Spectrum

The user-defined spectrum is created one band at a time. Use the \leftarrow and \rightarrow keys to move the cursor to the frequency band whose amplitude is to be changed, highlight the input amplitude field shown FIGURE 5-41. Press ENTER , use the \leftarrow ,

) ,) and) keys to input a numerical value and press ENTER to complete the process. In this example the cursor is on the 1 kHz frequency band, so if the amplitude were entered to be 50 dB, the result would be as shown in FIGURE 5-42

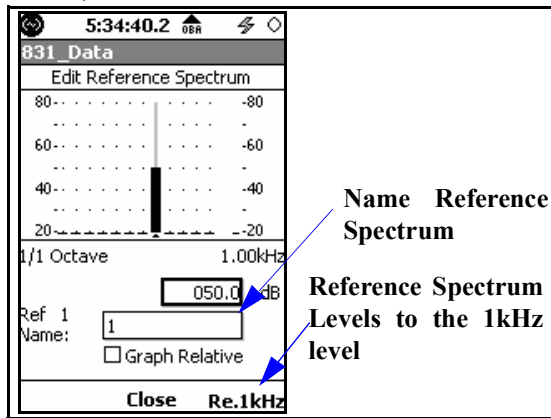

FIGURE 5-42 Example User-Defined Reference Spectrum; 50 dB @ 1 kHz

Continue this procedure band-by-band until the desired reference spectrum has been defined.

Saving a User-Defined Reference Spectrum

When the desired spectrum has been defined, highlight the **Name Reference Spectrum** field as shown in FIGURE 5-42, press ENTER, use the) ,) and) keys to input a name and press ENTER again to save this as a user-defined spectrum under this name.

Offset Reference Spectrum to 1kHz band level

Pressing the **Re.1kHz** softkey, as shown in FIGURE 5-42, will change all of the band levels to be offset relative to the level at 1 kHz (the level at 1 kHz will be subtracted from all band level values in the reference spectrum and the level in the 1 kHz band will be 0.0 dB).

Overall Display

In general, obtaining a normalized display of 1/1 and 1/3 octave spectra appearing on the **Overall** tab is the same as for Live Displays, described in "Live Display" on page 5-30. The major difference is that spectra appearing on the **Overall** tab display Leq, Lmax and Lmin data simultaneously, as shown in FIGURE 5-43.

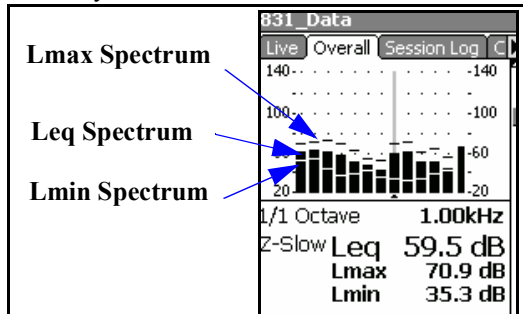

FIGURE 5-43 Overall Spectrum

As a result, when setting up for View Normalized, if no normalization spectrum has been selected, the display will look as shown in FIGURE 5-44.

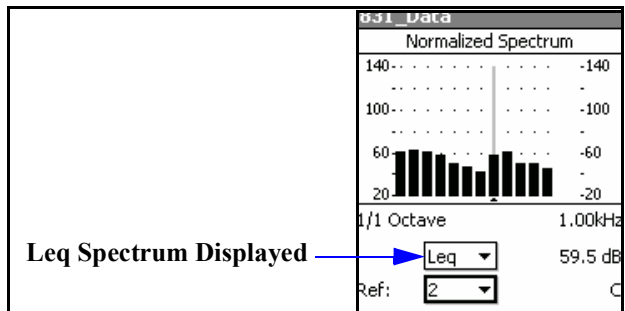

FIGURE 5-44 Normalized Overall Spectrum: No Reference Selected

The Leq in the data field shown highlighted above indicates that the spectrum being displayed is Leq. With this data field highlighted, press **ENTER** to open the menu shown in FIGURE 5-45.

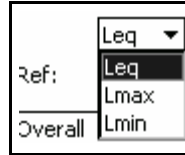

FIGURE 5-45 Spectrum Type Menu

Using this menu, the user can select from the three spectrum types; Leq, Lmax and Lmin. Highlight the desired parameter and press **ENTER** to make a selection.

If no reference spectrum has yet been defined, the displayed spectrum will correspond to the selected parameter.

Normalized using a Previously Measured Spectrum

Provided with a choice of spectrum types, the user can create a spectrum display where one type of spectrum is normalized by another. For example, let us use the spectrum type data field to select Lmin, then as a reference select 1. Press the left softkey **SET** to make the Lmin spectrum the reference spectrum for reference 1. The resulting spectrum will look like FIGURE 5-46.

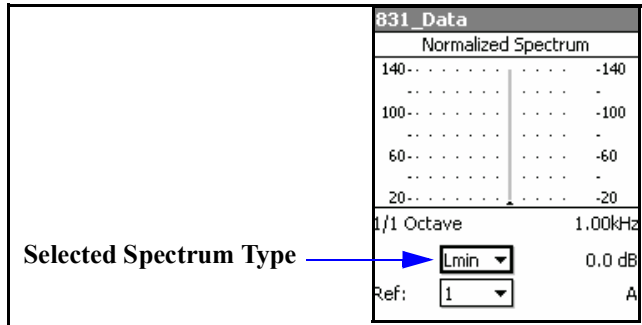

FIGURE 5-46 Lmin Spectrum Normalized to Lmin Spectrum

This display now shows the Lmin spectrum presently being measured, normalized by the Lmin spectrum that existed at the time the normalization was performed.

If the Model 831 has not been running since the normalization was performed, and we then change the selected spectrum type to Lmax, the display will show a spectrum whose amplitudes represent (Lmax - Lmin) of original spectrum, as shown in FIGURE 5-47.

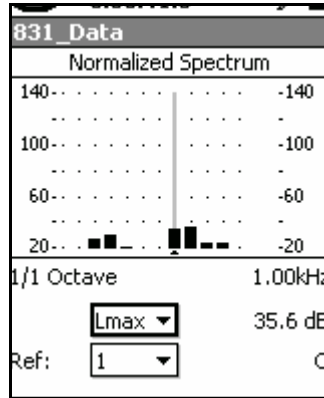

FIGURE 5-47 Lmax - Lmin Spectrum

If the Model 831 were still running, the Lmax would continue changing but the reference spectrum, based on the Lmin spectrum measured previously, would remain the same.

Normalizing using Frequency Weighting

When using frequency weighting for normalization, the display will be similar to that for Live Spectra, described in "Normalizing using Frequency Weighting" on page 5-34, except that the user will have the option of displaying any of the three spectra types, Leq, Lmax and Lmin, normalized by the frequency weighting used for the normalization, as shown in FIGURE 5-48.

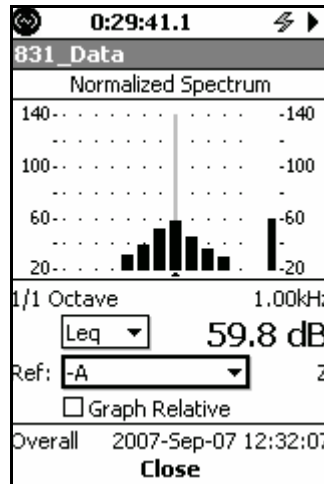

FIGURE 5-48 Leq Spectrum Normalized by - A

Normalizing using User-Defined Spectrum

The creation and use of user-defined reference spectra for the Overall Display are the same as for the Live Display, described in the section "Normalizing using User-Defined Spectrum" on page 5-35.

Graph Relative

When the Graph Relative has been enabled by placing a check in the Graph Relative check box, the graph is presented using a plus and minus about a vertically centered zero Y axis, as shown in FIGURE 5-49.

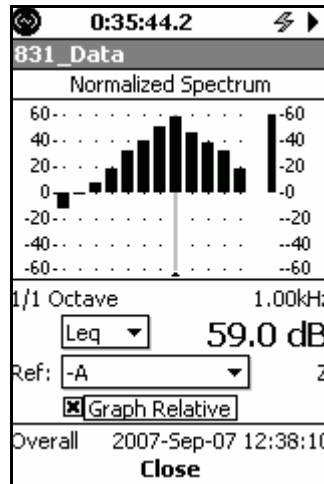

FIGURE 5-49 Normalized Spectrum: Graphed Relative

Any Level Display

In the displays shown in the above sections, the sound level values that appear are for user-selected values of frequency weighting, detector and peak weighting. However, the Model 831 is simultaneously calculating sound level values for all possible selections of frequency weighting (A, C and Z), detector (Slow, Fast and Impulse) and peak weighting (A, C and Z).

The Any Level Display can also be accessed from the Current and Measurement Display tabs, which are used to display Measurement History data; see Chapter 12 "Measurement History" on page 12-1.

To obtain the Any Level Display from either the Live or Overall screen, press Menu to open the menu shown in FIGURE 5-50.

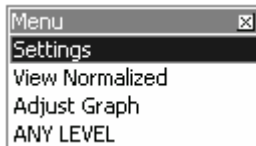

FIGURE 5-50 Menu

Highlight **ANY LEVEL** and press **ENTER** to obtain the Any Level Display. The data displayed will depend upon whether the Any Level Display was initiated from the Live or the Overall screen, as described in the following sections.

Live Screen

When initiated from the Live Screen, the Any Level Display will appear as shown in FIGURE 5-51

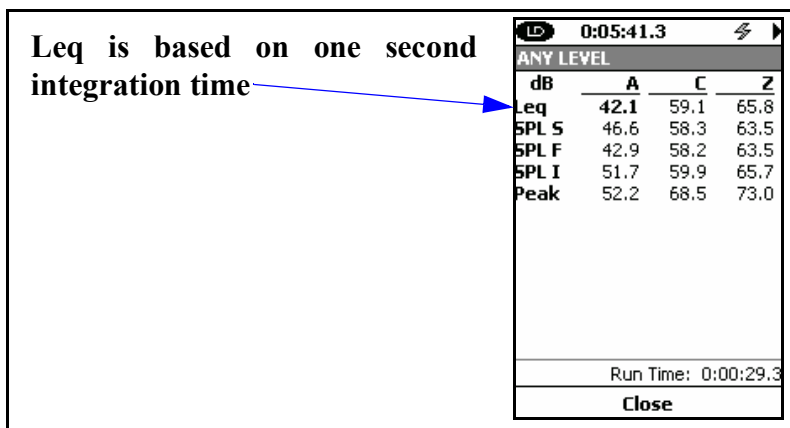

FIGURE 5-51 Any Level Display, Live Screen

These show the instantaneous sound levels using Slow, Fast and Impulse detectors and the Peak sound level, all using A, C and Z weighting. The displayed value of Leq is based on a one second integration time. Because they are instantaneous values, their numerical values will change rapidly in response to a change in sound level at the microphone.

Close Display

Note that the instrument keypad is not operational when the Any Level Display is being displayed. As a result, the run state cannot be changed until that display has been closed.

To close the Any Level Display, press the **Close** softkey.

Overall Screen

When initiated from the Overall Screen, the Any Level Display will appear as shown in FIGURE 5-52

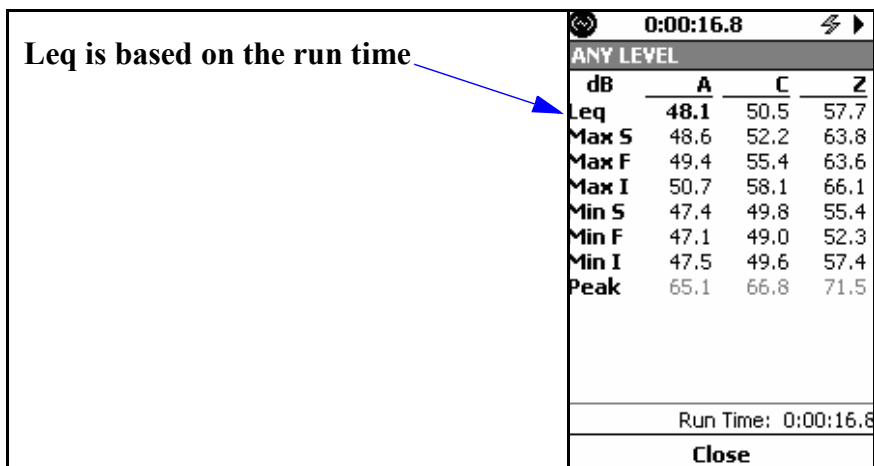

FIGURE 5-52 Any Level Display, Overall Screen

These data present an overview of the measurement performed over the run time, giving Leq, Maximum and Minimum levels corresponding to Fast, Slow, Impulse and Peak detection using A, C and Z weighting. .

Close Display

To close the Any Level Display, press the **Close** softkey.

Run Control

The Model 831 provides a number of run modes to control the time duration of a measurement. The most simple are Manual Stop, Timed Stop and Stop when Stable. More advanced are the Continuous, Single Block Time and Daily Timer modes. When combined with the Measurement History feature, these modes produce a sequence of measurements made and stored at regular time intervals. In this chapter the setup of run modes without the Measurement History are discussed in detail. The description of the setup and use of run modes with Measurement History enabled is continued in Chapter 12 "Measurement History" on page 12-1.

Run Control Setup

The Run Control is setup from the **Control** tab of the Measurement Setting Screen, as shown in Figure 6-1.

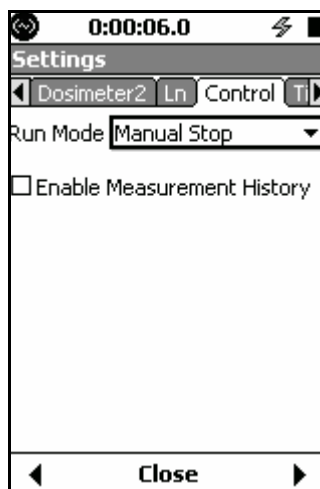

FIGURE 6-1 Control Tab

The **Control** tab is used to set the Run Mode for the measurement to be performed.



There are six modes of measurement duration available.

- **Manual Stop**
- **Timed Stop**
- **Stop When Stable**
- **Continuous**
- **Single Block Time**
- **Daily Time**

A brief description of each is presented in the following sections.

Manual Stop

The Stop key will stop a measurement while in this run mode.

When using Manual Stop, the measurement is initiated manually by pressing the  (RUN/PAUSE) key and is manually stopped by pressing the  (STOP) key. The setup procedure is described in ‘Manual Stop, Timed Stop or Stop When Stable’ on page 6-4.

Timed Stop

The Stop key will stop a measurement while in this run mode.

When using Time Stop, the measurement is initiated manually by pressing the  key and is stopped automatically after a user-defined time period. The setup procedure is described in ‘Manual Stop, Timed Stop or Stop When Stable’ on page 6-4.

Stop When Stable

The Stop key will stop a measurement while in this run mode.

When using Stop When Stable, the measurement is initiated manually by pressing the  key. The measurement will stop when the measured level has remained within a user-defined range and the measurement has run for a user-defined time period. The setup procedure is described in ‘Manual Stop, Timed Stop or Stop When Stable’ on page 6-4.

Continuous



When using Continuous, the Model 831 begins running whenever the Run key is pressed and when the power is turned on. A session log entry of type “Run” with a cause of “Power” is created at the same time. It is stopped by pressing the  key. Measurements are made continuously from the time of power-on to stop. The setup procedure is described in ‘Continuous’ on page 6-6.

The ability to restart when power is restored following a power failure, with documentation in the session log, is a valuable feature for long-term remote noise monitoring applications



If the unit stops due to a power failure, the session log is labeled as a type of “Stop” with a cause of “Power”. If, following a loss of power, the power is restored, the Model 831 will automatically begin running again.

If the unit is paused it will resume automatically after 5 minutes. This prevents loss of data due to an inadvertent pause, whether done manually or when the preamplifier cable is removed.

Single Block Timer

Using Single Block Timer, a single measurement is made for the time interval defined by the single block timer settings. The measurement may also be started or interrupted manually by pressing the  key or the  key. The Single Block Timer mode is often used to make a measurement for a period of one week. The setup procedure is described in ‘Single Block Timer or Daily Timer’ on page 6-8.

Daily Timer

Using Daily Timer, the measurement is initiated for one or more blocks of time every day within the programmed date range as set by the Daily Timer settings. The measurement may also be initiated or interrupted manually pressing the  key or the  key. The Daily Timer mode is often used to make a work area survey that follows a worker’s daily schedule for an entire work week. The setup procedure is described in ‘Single Block Timer or Daily Timer’ on page 6-8.

Run Mode with Measurement History

This chapter does not address Run Modes with Measurement History.



There are many applications where it is desirable to measure and store a sequence of measurements using the same setup, either manually or automatically. With the Model 831 this is facilitated using the Measurement History feature, which is described in detail in Chapter 12 "Measurement History" on page 12-1.

Run Modes Without Measurement History

All of the six Run Modes have a check box to enable the Measurement History feature, as is shown in the figures appearing in the sections which follow. The setup descriptions presented in the following sections are for setups without the Measurement History enabled.

When Measurement History is not enabled, at the conclusion of the measurement there will be a single measurement which must be manually stored.

Manual Stop, Timed Stop or Stop When Stable

When the run mode used is Manual, Timed Stop or Stop When Stable, a measurement is started by pressing the  key and ends when the  key is pressed, when the timer expires or when the signal is stable within a deviation. The selection and setting of appropriate parameters for these run modes is shown in FIGURE 6-2.

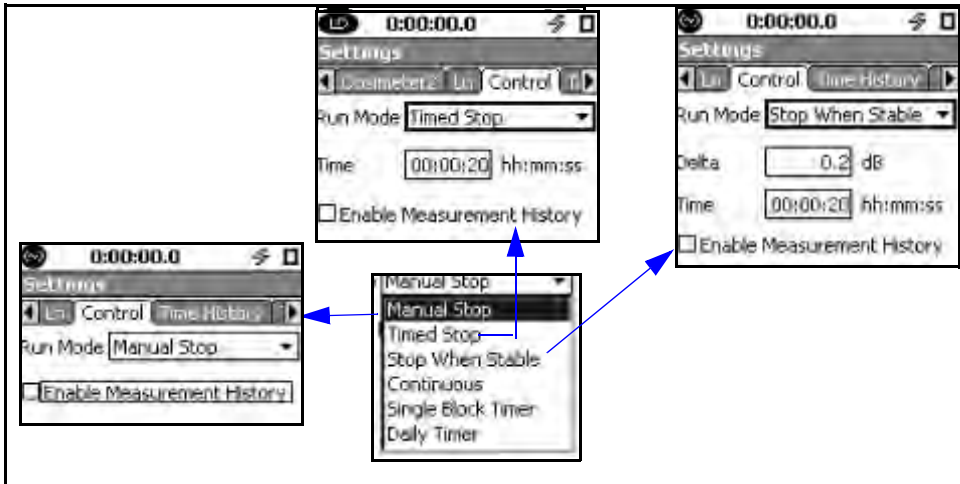



FIGURE 6-2 Setup of Manual Stop, Timed Stop, and Stop When Stable Run Modes
Manual Stop

The measurement is manually stopped by pressing the  key.

Timed Stop

The time at which the measurement is to stop is entered manually into the Time data field.

In the **Timed Stop** mode, the minimum **Time** of one second (00:00:01) will be saved if the time setting is left as **00:00:00** when closing or exiting the **Control** tab.

Stop When Stable

Suggestion: Press RUN after the noise source is on and in the desired condition. Starting a measurement prior to activating the noise source of interest may reduce the level measured and take longer than normal to stabilize.

The Stop When Stable feature is used to automatically end a measurement when the time average level has stabilized. It is often used in environments that have a rather continuous or repetitive noise source such as machinery. The stable condition is defined as when the Current measurement's average level (i.e. LAeq) does not vary from maximum to minimum by more than the entered Delta Level during the entered Time interval. To be stable, the total of all variations of the Current average level must also be less than two times the entered Delta Level; this condition detects amplitude modulation in the averaged level and prevents a premature stop. Shorter measurement times, though with less accurate results, are obtained by increasing the Delta Level or shortening the Time. Longer measurements, that are more representative of the true level, will be made with smaller Delta Levels and a longer Time entries.

Entering Delta Level

The Delta level is the maximum allowed change in Current average level (i.e. LAeq) permitted during the time interval defined below. The minimum level that can be set is 0 and the maximum is 5.0 dB. The default is 0.2 dB.

Entering Time

The Stable Time interval used for determining the stable condition is limited to 100s maximum. If time > 100s, it will run for the time set and then stop when variations in the Current average level over the last 100s are less than the Delta Level

The Time is the minimum interval that the measurement must run. The measurement will run for the interval specified and then continue until the stability condition was met. The smallest value that can be entered is 20 seconds and the largest is 99:59:59 (h:m:s). The default is 20 seconds.

For each, highlight the desired data field, enter the appropriate values and press  (ENTER).

Continuous

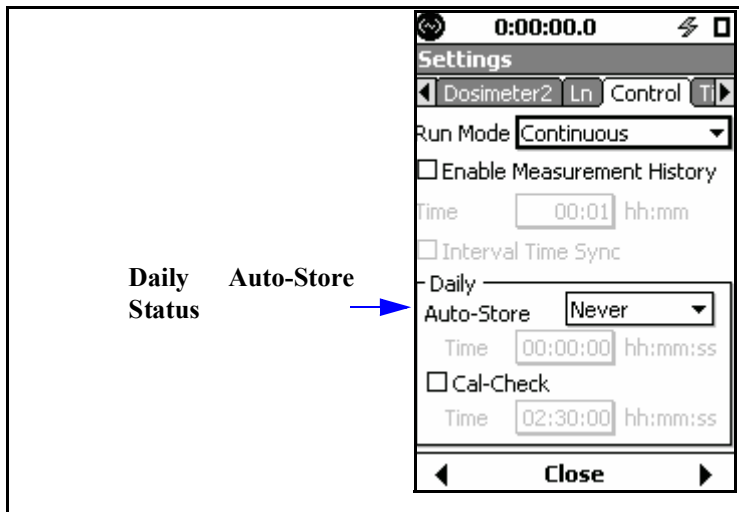



FIGURE 6-3 Setup of Continuous Run Mode

When using the **Continuous** Run mode, the measurement is initiated manually by pressing the  key and is manually stopped by pressing the  key.

With the **Enable Measurement History** option selected in this mode, a **Time** setting left as **00:00** (no time) will be saved as **00:01** (one minute) upon closing or leaving the **Control** tab.

Daily Reports

There are two daily reports available with the Continuous Run mode.

- Daily Auto-Store
- Daily Cal-Check

Daily Auto-Store

When Daily Auto-Store is set to "Never", as shown in FIGURE 6-3, the Continuous Run mode is essentially the same as the Manual Run mode, with the exception that in Continuous it automatically begins running, thus measuring continuously even when interrupted.

Daily Auto-Store permits the automatic storage of daily measurement reports for 24-hour time periods, beginning at a user-specified time. Each report can be configured to represent the complete 24-hour time period or to include data corresponding to equally-separated time periods within the 24-hours.

Highlight the Daily Auto-Store field and press **ENTER** to obtain the menu shown in FIGURE 6-4.



FIGURE 6-4 Daily Auto-Store Menu

When using Continuous run mode, data files are stored in the following format, regardless of what is specified in the **General** setup tab: **yymmdd00.LD0**, where **yymmdd** is the date the measurement was started.

Use the **←** and **→** arrow keys to select the desired number of measurements per day and press **ENTER**.

When any option other than "Never" is selected, a Time data field will appear as shown in FIGURE 6-5 to define the start time for the 24-hour time period to be used for the report.

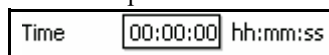

FIGURE 6-5 Auto-Store Report Start Time

Highlight each data field, press **ENTER** and use the arrow keys to set the parameters as desired. Press **ENTER** again to complete the selection.

Effect of a Noise Event

If a noise event, described in Chapter 13 "Event History" on page 13-1, occurs during the daily autostore, the storage operation is delayed. This delay would be implemented whether the status is Triggered or Valid. The autostore would be processed one minute past the normal autostore time or right when the event ends (not including the continuation process), whichever comes first.

Daily Cal-Check

When the Model 831 is used with one of the Larson Davis outdoor microphone preamplifiers, 426A12 or PRM2103,

you can program an automatic once per day calibration check of the system.

During calibration the LDN is paused. The net result has no effect on the history data while the calibration tone is on.

Highlight the Cal-Check field and press the **ENTER**, which will place a check in the Cal-Check check box and open the menu shown in FIGURE 6-6.



The screenshot shows a menu titled "Daily" with the following fields and options:

- Auto-Store: Never (dropdown menu)
- Time: 00:00:00 hh:mm:ss
- Cal-Check: Cal-Check
- Time: 02:30:00 hh:mm:ss
- Close button with left and right arrow indicators

FIGURE 6-6 Cal-Check Menu

Highlight the Time data field, press **ENTER** and use the arrow keys to set the time at which the calibration check is to take place. Press **ENTER** again to complete the selection.

The calibration check information will be provided within the Daily Report.

Single Block Timer or Daily Timer

When the run mode is Single Block Timer or Daily Timer, each measurement will consist of data measured over different blocks of time between the start date and time and the end date and time.

The selection and setting of appropriate parameters for the Continuous, Single Block Time and Daily Timer run modes is shown in FIGURE 6-7.

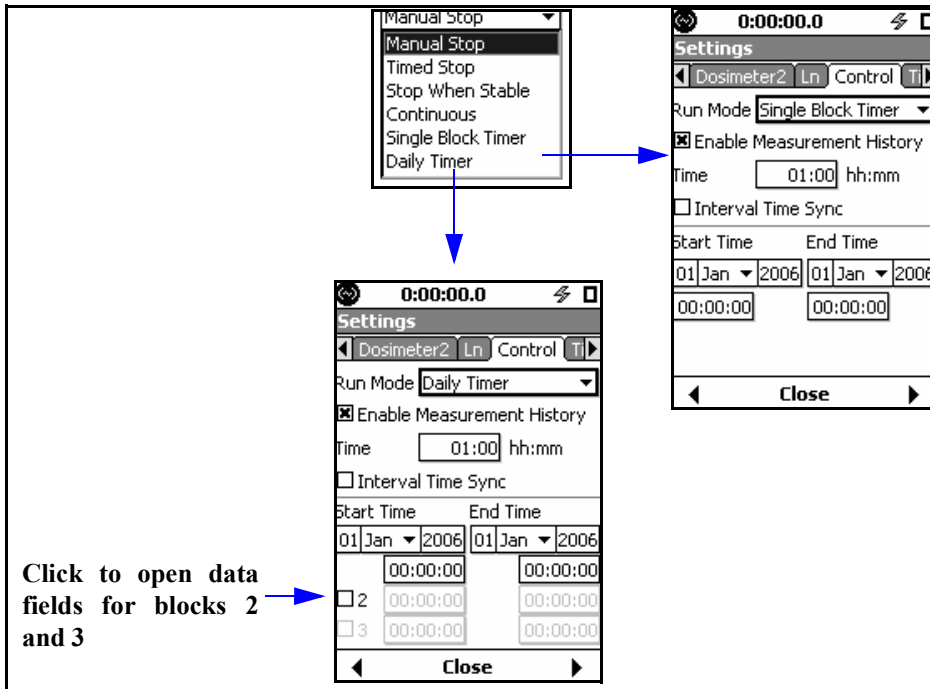

FIGURE 6-7 Setup of Single Block Timer and Daily Timer Run Modes

Measurements are initiated for one or more time blocks within the selected Start Date and End Date.

Highlight each data field individually, press **ENTER** and use the arrow keys to set the parameters as desired. Press **ENTER** again to complete the selection. The following example illustrates several important considerations in setting up these Timer modes.

Example

As an example, suppose we have begun a daily timer setup as shown in FIGURE 6-8.

	Start Time	End Time
	23 Jun 2008	25 Jun 2008
	23:59:00	00:00:04
<input checked="" type="checkbox"/> 2	00:00:00	00:00:00
<input type="checkbox"/> 3	00:00:00	00:00:00

FIGURE 6-8 Daily Time Setup Example

The selected blocks should not overlap. For example, if the End Time 1 is set to 00:00:04, then the Start Time 2 should be greater than 00:00:05 and it should not be greater than Start Time 1.

A measurement block can span over midnight. So, in the example, these measurements would be recorded.

1. 23:59:00 pm 6/23/2008 to 00:00:04 on 06/24/2008
2. 23:59:00 pm 6/24/2008 to 00:00:04 on 06/25/2008
3. 23:59:00 pm 6/25/2008 to 00:00:04 on 06/26/2008

This means that even though our date selected range is between 23rd and 25th, the stop time can be past the date range. Hence, the selected date range controls only the time of initiation of the measurement.

All the measurements made between the date ranges would be part of a single file unless there has been a manual intervention. irrespective of the way the auto-store preference is set. It would behave as if it was set to None.

If a measurement is manually stopped in the middle of a block, no measurement would be initiated until the next valid start time.

If a measurement is manually started, the measurement would stop automatically at the next valid stop time.

With the **Enable Measurement History** option selected in these modes, a **Time** setting left as **00:00** (no time) will be saved as **00:01** (one minute) upon closing or leaving the **Control** tab.

Making a Measurement

In this chapter we describe how to make and store an accurate sound level measurement. Before doing this, make sure that the Model 831 has been setup to meet the requirements for the measurement as described in Chapter 4 “Basic Measurement Setup” on page 4-1.

Configuration of the System

The System Model 831 should be configured with the preamplifier connected to the front of the instrument and the microphone connected to the end of the preamplifier.

Switching On the Model 831

Do not use the hardware power switch to turn the Model 831 OFF. This may cause data to be lost. See “External Power Supply” on page 2-8 for additional information on the use of the hardware power switch.

With fresh batteries installed, press the  (ON/OFF) key, to switch on the Model 831.

Start-up Period

With standard memory, the start-up period will be less than two minutes. With the optional 2 GB memory, the startup period can be several minutes for the first boot-up. As the instrument is starting up, the display will show the following screen.



FIGURE 7-1 Boot Graphic

Disk Check During Boot-up

The Model 831 will check the internal flash memory during boot-up when any of the following conditions occur:

- The Model 831 was improperly shutdown. For example, a shutdown due to lockup or lack of power
- If the Model 831 has been rebooted 29 times since the last memory check
- If the Model 831 has been more than 180 days since the last memory check

Data View and Data Display screen refer to **Live**, **Overall** and **Session Log** tabs.

When the Model 831 is fully started, the Data Display Screen will appear as shown in Figure 7-2.

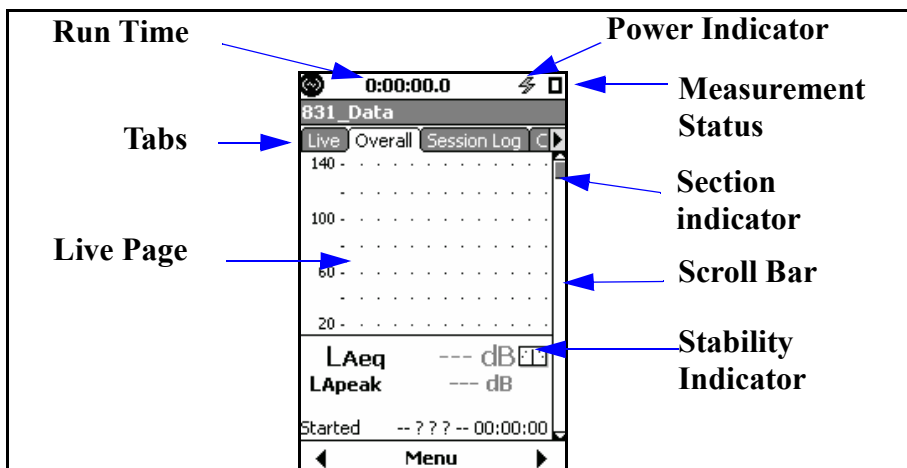



FIGURE 7-2 Data Display Screen

The  (STOP/STORE) key will produce a steady red light to indicate that the Model 831 is in the stopped state with no data yet measured.

Model 831 Setup

Set the measurement parameters of the Model 831 as described in Chapter 4 “Basic Measurement Setup” on page 4-1.

Calibrating the Model 831

The Model 831 must be calibrated using a sound level calibrator prior to performing a measurement. The procedure for calibration is described in Chapter 8 “Calibration” on page 8-1.

Positioning the Model 831

Observer Position

The meter will be either mounted upon a tripod or held in the hand. In order to avoid the effect of sound reflections from

the body of the operator interfering with the measurement, the meter should be located as far as possible from the body. Thus, when actually performing the measurement, the operator should place himself at a distance behind the tripod-mounted meter, or extend the hand-held meter as far from the body as is comfortable.

Microphone Extension Cable

Note that the electromagnetic emissions compliance testing was performed using only a 10 ft. EXC010 extension cable, as described in “CE Information” on page A-18

If desired, a shielded microphone extension cable may be placed between the meter and the preamplifier/microphone. No correction is required when using Larson Davis Model EXCXXX microphone extension cables in combined lengths up to 200 feet. XXX is the length in feet (XXX = 010, 020, 025, 035, 050, 060, 100 and 200 available).

When doing so, take care that the preamplifier/microphone is held or mounted in such a way to minimize the effect of reflections on the sound field near the microphone.

Use of a Windscreen

Wind blowing across the microphone generates pressure fluctuations on the microphone diaphragm which can produce errors in the measurement. As a result, when performing measurements in the presence of low level airflows, it is recommended that a windscreen be placed over the microphone. Larson Davis provides the WS001 windscreen, a 3 1/2” diameter ball made of open cell foam which can be placed over the microphone and preamplifier as shown in FIGURE 7-3.



FIGURE 7-3 Position of Windscreen



To install the windscreen, hold the meter in one hand and the windscreen in the other. Insert the microphone/preamplifier assembly into the opening in the windscreen as shown in FIGURE 7-4 and slide the windscreen completely down over the preamplifier.



FIGURE 7-4 Placement of Windscreen

Prior to beginning the measurement, select the Live View. You can now see a live display of the instantaneously measured data.

The position of the vertical scroll bar on the right side of the display indicates the page being displayed relative to the available pages; first page at the top, last page at the bottom.

The data available for display from the Live View is distributed over three pages (four or five pages with the optional OBA feature). Use the  and  keys to change pages.

Take a minute or so to examine these different displays before continuing with this example.

Use the softkeys to select the Overall View. Note that the measurement and display of data has not yet begun and that the measurement run time displayed at the very top of the screen indicates 00:00:00:0.

Performing the Measurement

Starting the Measurement

The Model 831 uses a single range for sound level measurements, so there is no need to select a range as part of making a measurement. Select the Overall Display in order to observe the measurement results or accumulation in progress.

The Live Display provides a running sound level measurement whether or not the 831 is actually performing a measurement while the Overall Display provides the measurement actually being made. Select the Overall Display in order to observe the measurement in progress.

Press the  (RUN/PAUSE) key to start the measurement, which will start the run clock and initiate the measurement and display of overall data.

Hardkey LED Colors

Two of the hardkeys have colored LEDs behind them, as indicated below:

-  key LED is Green

-  key LED is Red

When performing a measurement, the state of the Model 831 is indicated by the illumination of these two keys indicated in Table 7-7-1.

Measurement State	Red	Green
Stopped, Reset	ON, flashing twice every 3.2 sec	Off
Stopped, with unstored data	ON	Off
Stopped, data stored	ON, flashing twice every 3.2 sec	Off
Paused	ON, flashing	Off
Running	Off	ON
Waiting for valid data to begin running ¹	ON	ON, flashing

Table 7-1 Measurement State as Indicated by Green/Red LEDs

¹ The state of waiting for valid data will occur when the instrument is first switched On, and also following a filter reset (performed by pressing the  (Reset) key when the Model 831 has already been reset).



To conserve power usage, when no key has been pressed for a period equal to ten times the Backlight Time, the state of the Model 831 is indicated in Table 7-7-2.

Measurement State	Red	Green
Stopped, Reset	ON, flashing once every 3.2 sec	Off
Stopped, with unstored data	ON, flashing twice every 3.2 sec	Off
Stopped, data stored	ON, flashing once every 3.2 sec	Off
Paused	ON, flashing	Off
Running	Off	ON, flashing twice every 3.2 sec
Waiting for valid data to begin running	ON	ON, flashing rapidly

Table 7-2 Measurement State (after period without key presses)

Data Display

See “Overall Tab” on page 5-12.

The measured data are available for display from the Overall View. These data are distributed over thirteen sections (with the 831-IH and 831-OB3 options). Use the  and  keys to change sections. The first two sections from the top present basic sound level parameters as shown in FIGURE 7-5 and FIGURE 7-6.

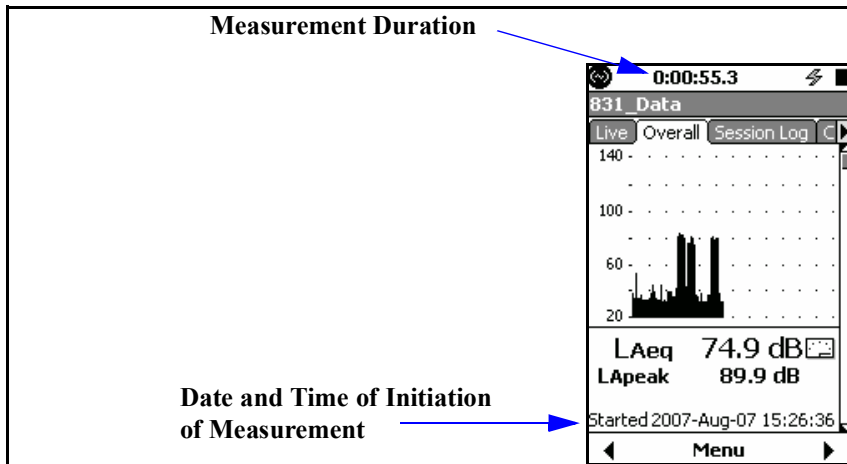

FIGURE 7-5 Leq and Running SPL

The two digital displays present the frequency weighted Leq value ($L_{Aeq} = 74.9$ dB) and the frequency weighted Lpeak value ($L_{Apeak} = 89.9$ dB). Both of these were measured using A-weighting as indicated by the **A**. The duration of the measurement is indicated at the top of the display and the data and time that the measurement was initiated are indicated at the bottom of the display. The graph represents the profile of the Leq as a function of time during the entire measurement period.

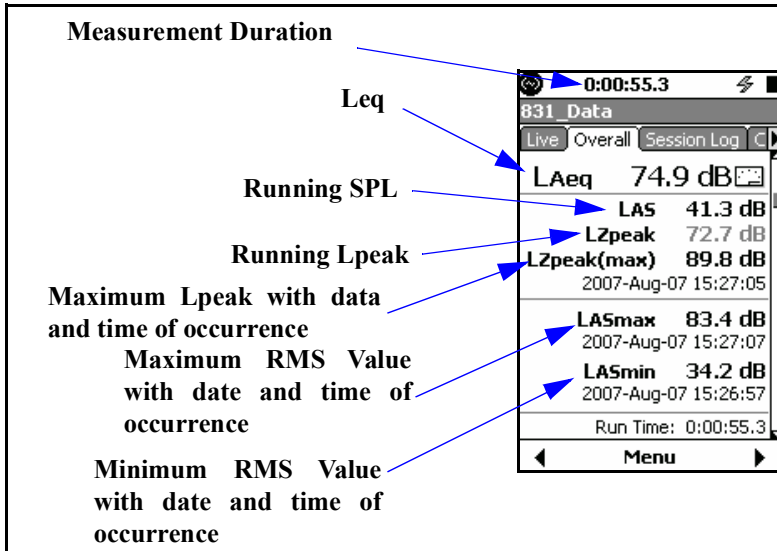

FIGURE 7-6 Multiple Sound Level Parameters

Measurement Range

The measurement ranges over which the Model 831 meets the standards, which depend upon the selected frequency weighting, as shown in “Performance Specifications” on page A-3. Measurements which include levels outside this range should not be considered accurate. An overload indication will appear when levels above the range appear. However, the user should take care not to rely on measurements whose levels are below the lower limit of the specified range.

Overload/Under Range Levels

For further information on determination of overload level and under range levels, see “Sensitivity Tab” on page 8-13.

As part of the calibration procedure, an overload level (dB Peak) and under range sound pressure levels for A, C and Z-weighting are determined for the instrument setup and microphone/preamplifier combination being used. These are displayed on the Microphone Page as shown in FIGURE 8-12 “Sensitivity Tab” on page 8-14.

Overload Indication

When a signal from the preamplifier exceeds the calibrated input range of the Model 831, the Input Overload Icon will appear at the top of the display.



While the overload is present, the icon will flash on and off. If an overload occurs while running the overload icon will latch on and will not be removed from the display. A reset will clear the icon.

Under Range Indication

When the signal from the preamplifier drops to the point where the noise level of the instrument and the preamplifier influence the measurement, an under range condition exists. When this happens the Under Range Icon will appear.



As long as the under range condition exists, the icon will flash. When the measured level no longer produces an under range condition, the icon will be removed from the display.

At any time when a measured parameter is in an under range condition, its numeric display will appear in gray rather than the usual black, as shown FIGURE 7-7.

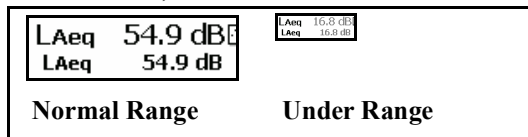





FIGURE 7-7 Normal vs Under Range Data Display

Pausing the Measurement

At any time the measurement of overall data can be temporarily suspended by pressing the  key. Note that the run clock will not pause. However, instantaneous data will continue to be displayed in the Live View.

When paused, the  key will produce a flashing red light.

Pressing  key one more time will cause the measurement to begin again. The  key will produce a steady green light, and overall data will continue to be accumulated. The overall data will not be affected by any acoustic events occurring during the time period that the Model 831 was paused.

Note that a measurement may be paused and then run again multiple times.

Back Erase

The back erase function permits the user to rapidly delete from the measurement the effects of acoustical events that have occurred during the previous five or ten seconds.

Back Erase Disabled

The back erase feature is unavailable when any of the following have been enabled:

- Measurement History, described in “Measurement History” on page 12-1.
- Event History, described in “Event History” on page 13-1.
- Spectral Ln, described in “Spectral Ln Mode” on page 4-7.
- Event Sound Recording, “Noise Event Sound Recording” on page 16-21

Back Erase Implementation

The back erase is implemented when the measurement is paused, as described in the preceding section. When the measurement is paused, the center softkey will be labeled **Back-5s**, as shown in FIGURE 7-8.

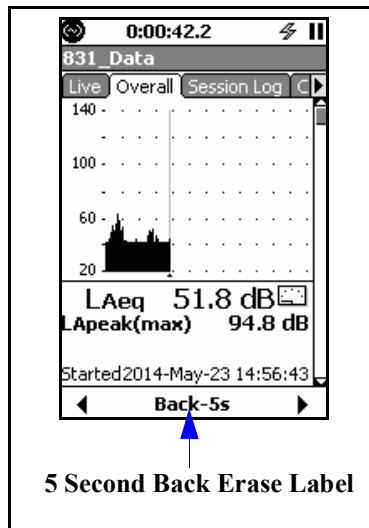

FIGURE 7-8 Five Second Back Erase Label

The Back-5s label does not appear until the measurement duration is of least 5 seconds or more since the last Stop or Pause.

Press the center softkey to implement the five second back erase. The center softkey then shows an undo option (unless it has been more than 10 seconds, in which case it shows a longer back erase option, as described below).

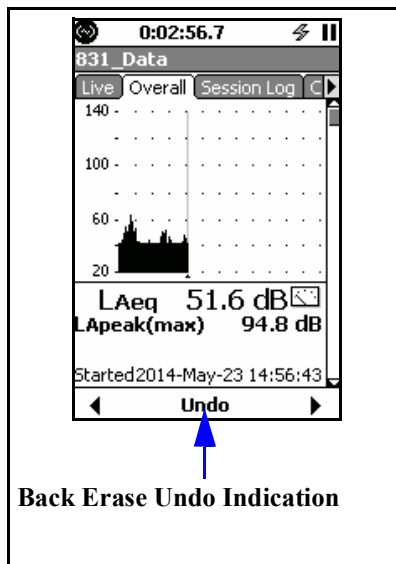



FIGURE 7-9 Back Erase Undo Indication

The user can take one of the following actions:

- Press the  key to continue the measurement with the five second segment removed.
- Press the center softkey to implement the **Undo** action and then press the  key to resume the measurement without removing the previous five second time segment.

> Ten Seconds Since Last Stop or Pause

After pressing the center softkey to implement a five second back erase, if the measurement duration since the last Stop or Pause has been more than ten seconds, the center softkey will then be labeled **Back-10s**, as shown in FIGURE 7-9.

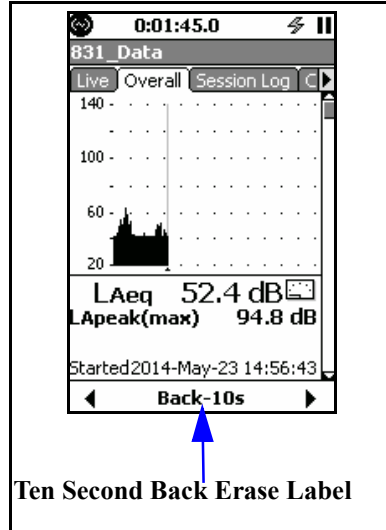





FIGURE 7-10 Ten Second Back Erase Label

The Back-5s label does not appear until the measurement duration is of least 5 seconds or more since the last Stop or Pause.

Now the user can take one of the following actions:

- Press the  key to accept the five second back erase and continue the measurement.
- Press the center softkey to extend the back erase to ten seconds. The center softkey will then be labeled **Undo** as shown in FIGURE 7-9.

The user can then take one of the following actions:

- Press the  key to accept the ten second back erase and continue the measurement.
- Press the center softkey to implement the undo action and the press the  key to continue the measurement without removing the previous ten second time segment.

Modified Profile Graph

After a back erase operation has been performed, the sound level profile graph will be modified to indicate the erase operation as shown in FIGURE 7-11.

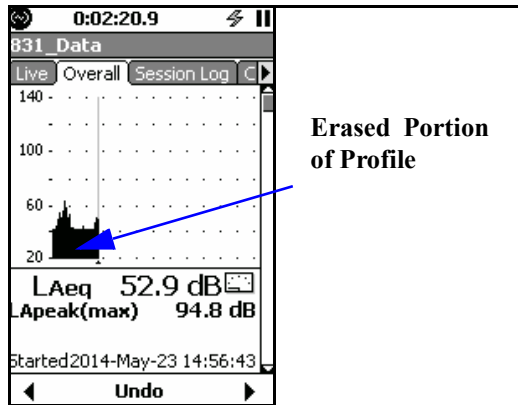



FIGURE 7-11 Modified Profile Graph

Time History Records

The time history records from the point data were restored from to the last record will be marked as back erase records.

Resetting the Measurement

A measurement is most often reset when a noise event which is not typical of the measurement desired takes place. For example, an aircraft passing overhead when attempting to measure the background noise in a normally quiet area.

To reset a measurement in progress, press the  (RESET) key. This will erase all data previously measured and reset the run time clock to zero. A reset will not reset stored data files. A reset can be initiated when the Model 831 is running, paused or stopped. However, it must be stopped for the reset operation to be performed.

Resetting When Running or Paused



If it is running or paused when the  key is pressed, a Stop Required Menu will be displayed as shown in FIGURE 7-12.



FIGURE 7-12 Stop Required Prompt

The **OK** response will already be highlighted, so simply press the  (ENTER) key to continue.

Otherwise, highlight **Cancel** and then the  to cancel both the Stop and the Reset operations.

After selecting to Stop the measurement, the Save File Menu, shown in FIGURE 7-13, will appear to provide a choice of saving the measured data prior to the reset or not as described in “Storing the Measurement” on page 7-15.

Resetting When Stopped

If the Model 831 is stopped when the  key is pressed, the Stop Required Menu will not appear, but the Save File Menu will appear to provide a choice of saving the measured data prior to the reset or not.



After the reset has been performed, the  key will produce a steady red light to indicate the measurement state as Stopped, Reset.



Starting a New Measurement

The  key (RUN/PAUSE) key must be pressed to start a new measurement.

Stopping the Measurement

Note that the Model 831 can be stopped when either running or paused.

Press the  key to suspend the overall measurement, which will also stop the run clock. Stopping the measurement with data not yet stored will cause the  key to flash red every 3.2 seconds.

Pressing the  key afterwards will continue the overall measurement which had been stopped. The run clock will also begin again from the time indicated when the stop had occurred. This will also cause the  to produce a steady green light.

Storing the Measurement

A measurement can only be stored when the measurement has been stopped.

To store the measurement, press the  key one more time while stopped. The Save File menu will then be displayed, as shown in FIGURE 7-13.

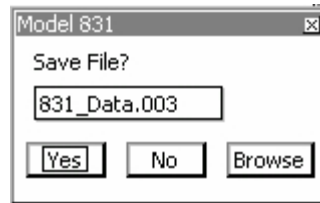







FIGURE 7-13 Save File Menu

When the Spectral Ln Mode is On, as described in “Spectral Ln Mode” on page 4-7, the entire Ln distribution table is stored. This may take several seconds. During this time a run cannot be initiated, but data can be viewed.

The data file name will be set to the name defined in the section “General Tab” on page 4-3 (831_Data.003 in FIGURE 7-13) along with a file number. The file number automatically begins at 001 for the first measurement stored and will index so that whenever a measurement is stored the file number assigned will be the next in sequence.

The data file name can be changed by highlighting it with the up arrow key, press , make changes as desired, and press  to save the changes.

After a file has been successfully stored, the Model 831 will automatically reset when the  (RUN/PAUSE) key is pressed to begin another measurement.

To continue with the save operation, highlight **Yes** and press the  key. The  key will produce a steady red light to indicate the measurement state as Stopped, Stored.

To abort the save operation, highlight **No** and press .

Overwriting a Saved File

If you wish to use this data to replace a data file already saved in the Model 831, instead of highlighting **Yes** or **No**, highlight the box with the title “...” and press the . This will open a window listing all the data files already saved in the Model 831, as shown in FIGURE 7-14.

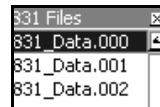

FIGURE 7-14 Saved Data Files

Highlight the file which is to be overwritten and press **ENTER**. This will replace the file name and number which previously appeared with this one, as shown in FIGURE 7-15.

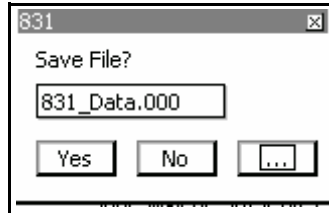

FIGURE 7-15 Overwriting a Saved File

To continue with the overwrite operation, highlight **Yes** and press **ENTER**.

To abort the overwrite operation, highlight **No** and press **ENTER**.

To select a different previously saved file to overwrite, highlight the box with the title “...” and press **ENTER** to repeat the overwrite procedure.

Low Level Sound Fields

As long as the sound level being measured is within the measurement range shown in “Performance Specifications” on page A-3, inherent (self-generated) noise and linearity problems can be ignored.

It is possible to manually correct the measured RMS sound pressure levels for the typical inherent noise levels (see the noise floor specifications in “Performance Specifications” on page A-3) as long as the difference between the measured sound level and the inherent noise level is greater than 3 dB. This is done by subtracting the inherent sound level from the total sound level using the following formula.

$$L_{corr} = 10\log(10^{(L_{meas})/10} - 10^{(L_{inh})/10})$$

where

Lcorr = corrected sound level
Lmeas = measured sound level
Linh = inherent noise level

Recovery After Improper Shutdown

NOTE: There is a risk of file-system corruption when power to the system is unexpectedly shut off. To minimize this risk, always follow proper shutdown procedures.

When the Model 831 has been shutdown improperly, for example a loss of power during a measurement, the procedure for handling data depends upon the setup being used at the time.

Case 1

If the Run Mode is:

Continuous

or

Single Block Timer

or

Daily

and

Daily Autostore is enabled

Normal Operation

Under normal operation the data files are stored with the following name format:

yymmdd00.LD0

where yymmdd is the date the measurement was started.

Improper Shutdown

When the instrument is powered up following an improper shutdown, the data is automatically stored in the following name format:

yymmddxx.RC0

where yymmdd is the date the measurement was started and xx is a sequence number that will prevent the new filename from conflicting with a previously stored file.

Case 2

This case covers all setups other than those described in Case 1.

Improper Shutdown

Following an improper shutdown, when the instrument is next turned On:

Step 1 The user is prompted to save the data.

- If the user responds by selecting to store the data, the data is stored and the instrument is reset

- If the user responds by selecting not to store the data, the sequence moves to Step 2.

Step 2 The user is prompted to reset the instrument

- If the user responds by selecting to reset the instrument, the instrument is reset.
- If there is no user response to the prompt within ten seconds, the instrument is reset.
- If the user responds by selecting not to reset the instrument, the sequence moves back to Step 1.

When the user is present, he/she must eventually select to store the data, reset the instrument, or take no action, in which case the instrument will be automatically reset.

This sequence is diagrammed below

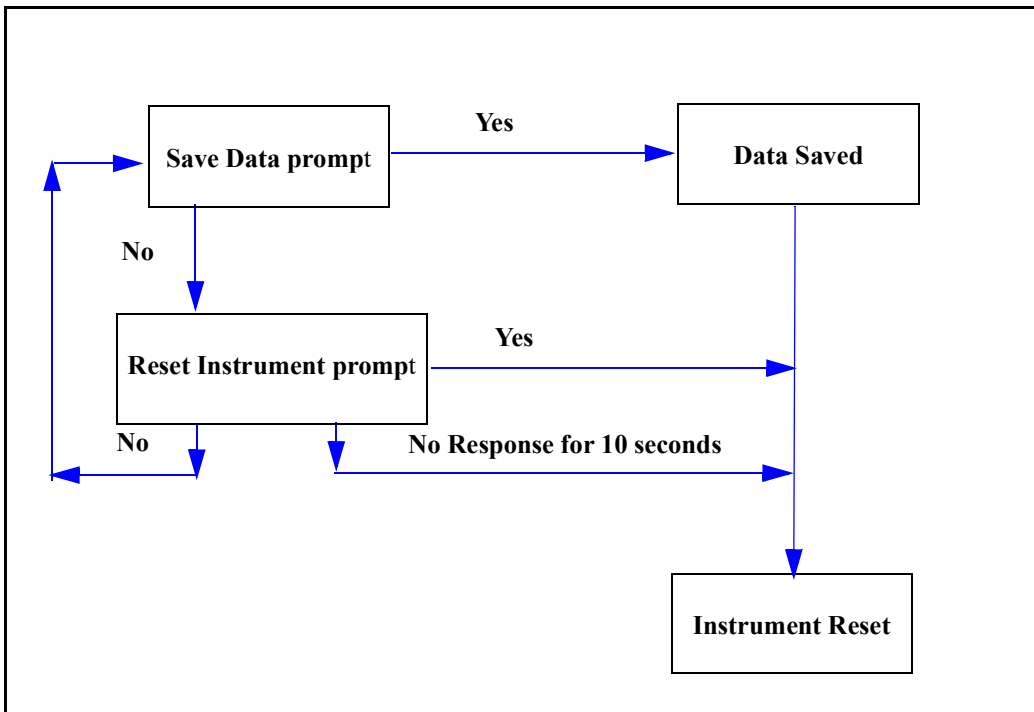

FIGURE 7-16 Improper Shutdown Sequence, Case 2

Calibration

This chapter describes both the purposes and steps for calibrating the Model 831.

Calibration Overview

Sensitivity Determination

The primary role of sound level meter calibration is to establish a numerical relationship between the sound level at the diaphragm of the microphone and the voltage measured by the meter so that the sound pressure level can be read directly from the display of the meter in units of dB. The result of a calibration is the determination of the sensitivity of the meter, including microphone and preamplifier, typically in units of dB re 1V/Pa or mV/Pa.

Overload/Under Range Conditions

A secondary role of calibration is to determine the sound level which would overload the instrument and the minimum sound level which can be accurately measured, referred to as the under range level. This requires a knowledge of the electrical noise levels of the microphone, preamplifier and the instrument circuitry.

Calibration Stability

The Model 831 should maintain a stable value of sensitivity over long periods of time. Significant changes in sensitivity, or a pattern of small but regular sensitivity changes, are indicative of problems with the measurement system calling for laboratory calibration and possibly service. To assist the user in identifying these situations, the Model 831 provides two notifications:

Calibration History

Data and date/time of the most recent ten calibrations.

Large Change Notification

During calibration, an automatic comparison is made between the sensitivity determined by the calibration and a published value of sensitivity. An on-screen window will

appear to warn the user when the difference between these two values exceed 3 dB.

Control Panel - Calibrate

To activate the Calibration function, press the  (TOOLS) key and highlight the Calibrate icon as shown below.



FIGURE 8-1 Control Panel

Press the  (ENTER) key to open the Calibrate tabs.

With the PRM2103 preamplifier, the E.A. Check, E.A. History, and E.A. Check Spectrum tabs do not appear. For more information, see the PRM2103 Outdoor Microphone Preamplifier Manual.

FIGURE 8-2 shows the calibration tabs that appear with the PRM831 preamplifier for the Model 831.

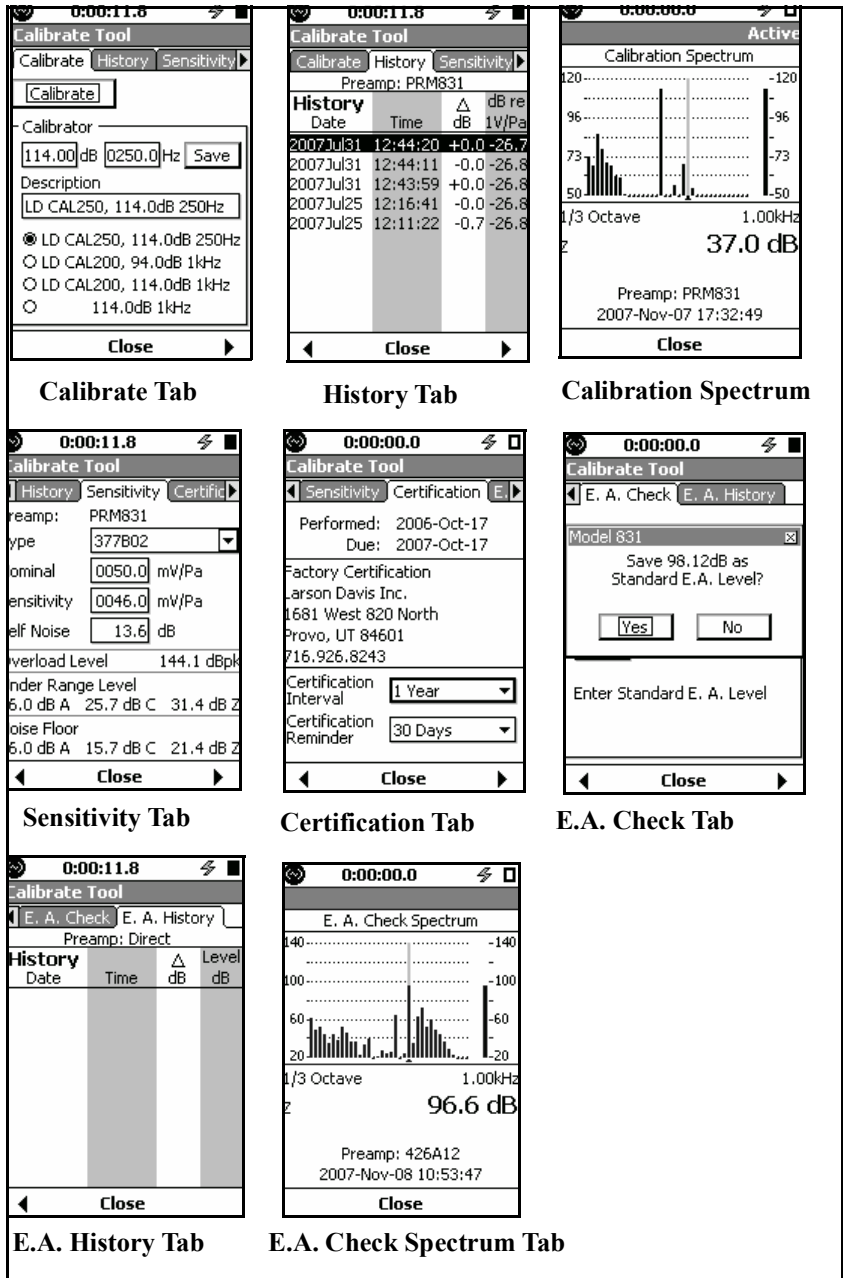

FIGURE 8-2 Calibration Tabs

Calibrate Tab

The **Calibrate** tab is used when performing an acoustic calibration, including the selection of the sound level calibrator to be used and the implementation of the calibration procedure.

History Tab

The **History** tab lists the results, along with the date and time, of the ten most recent calibrations performed using the same type of preamplifier as presently connected to the Model 831, whose name appears at the top of the tab (PRM831 in this example). The preamplifier type is read automatically when the instrument is booted up, or following a change in preamplifier. The value of sensitivity in dB re. 1 V/Pa and the variation of the sensitivity determined from that calibration relative to the calibration prior to that, Δ dB, are presented for each calibration.

Sensitivity Tab

When performing an acoustic calibration, the **Sensitivity** tab is used to select the microphone being used.

Certification Tab

The **Certification** tab shows the date of the last certification and the due date for the next certification. Information about the calibration facility. Typically Larson Davis, Inc. is displayed in the middle of the tab. The user can enter their own certification interval and certification reminder from this tab.

Exiting from the Calibration Function

Press the **Close** Softkey to exit from any of the Calibrate tabs to the Control Panel.

Acoustic Calibration

When using a 426A12 Outdoor Microphone and Power Supply or a Model 2100 Outdoor Preamplifier, a calibration check can be performed remotely using an electrostatic actuator (E.A.) as described in "E.A. Check" on page 8-18.

This is the most commonly used calibration method, and the one required by most national and international standards prior to performing a measurement. A sound level calibrator is used to apply an acoustical signal of a known amplitude and frequency to the microphone. From the voltage level measured by the meter the sensitivity can be determined. In this technique one is obviously assuming that the calibrator is functioning correctly; any variation in level from that expected will result in an improper calibration and an erroneous value of sensitivity. For this reason, the user is advised to compare the newly determined sensitivity with the previous sensitivity to ensure that significant variations have not occurred.

Frequency Weighting

The Model 831 automatically switches to C frequency weighting and Fast detector response for calibration. This permits 250 Hz and 1000 Hz calibrators to be used. The Fast detector response reduces the stabilization time required before calibration. If the OBA is enabled and the OBA range is set to Low, an OBA overload will occur due to the amplitude of the calibrator output signal. Therefore, the OBA range is automatically switched to high for the calibration.

After calibration, the Model 831 returns to the original frequency and time weighting set by the user. If the OBA is enabled, the OBA range is also restored to that set by the user.

Calibrator

The calibrator section of the Calibrate tabs, shown in FIGURE 8-2, includes an area to enter information about a calibrator and a list of calibrators. The user may select a calibrator from the list or enter new information about a calibrator.

Recommended Calibrator

If using a 1/4" microphone, the adaptor ADP024 is required.

Larson Davis recommends the following calibrator:

- Larson Davis Model CAL200: 94/114 dB @ 1 kHz

Model 831 with 1/2" Free-Field Microphone

The CAL200 provides a nominal pressure level of 94 dB or 114 dB. The exact levels are printed on the Larson Davis calibration sheet that came with the calibrator. When using a free-field microphone, the pressure level at the microphone diaphragm will be slightly different. Thus, a free field correction of -0.12 dB should be applied to either of these levels. Pressure and random incidence microphone do not require a correction of this type. If the calibrator and instrument are near room temperature (23° C) and near sea level (101.3 kPa) then no other corrections need to be made. If the calibration sheet for the CAL200 indicates 113.98 dB for it's level when set to 114 dB then set the Cal Level in the Model 831 to 113.86 dB and 1kHz.

When the microphone and instrument are at a temperature other than near room temperature or static pressures not near sea level, then corrections will need to be added for the ambient temperature and the prevailing static pressure. Check the calibration data shipped from Larson Davis with the CAL200 to get these corrections. The corrections can be added to the level obtained in the previous paragraph to get the actual level of the CAL200.

The microphone's sensitivity varies with static pressure. If the instrument is calibrated in one environment and moved to another, then the sensitivity will change (after stabilization) depending on the change of temperature and pressure. The coefficient of static pressure is -0.01 dB/kPa. If the system is calibrated at 85 kPa for instance then it will be 0.16 dB less sensitive at sea level. The sensitivity of the microphone and Model 831 varies slightly with temperature also. The coefficient of temperature is -0.009 dB/°C. If the system is calibrated at 18 °C then it will be 0.05 dB less sensitive at 23 °C.

The Larson Davis 3" Wind Screen has less than 0.05dB effect on the system response at 1 kHz.

Environmental Parameter Ranges

For proper calibration of a Class 1 sound level meter such as the Model 831, the calibration procedure and the correction values apply over the ranges presented in Table 8-1.

Parameter	Range
Static Pressure	65 kPa to 108 kPa (9.4 psi to 15.7 psi)
Temperature	- 10 °C to + 50 °C (14 °F to + 122 °F)
Humidity	25 % to 90%, without condensation from - 10 °C to + 39 (14 °F to + 102.2 °F)

Table 3-1 Environmental Parameter Ranges for Calibration

Set the CAL200 level switch to 114 dB.

Adding a Calibrator

Refer to the calibrator certification sheet for the calibration level

When adding a calibrator to the list, the following information may be entered:

- Calibration Level
- Calibration Frequency
- Calibrator Description

The calibration level and frequency values are as specified in section ‘Model 831 with 1/2” Free-Field Microphone’ on page 8-6.

Looking at FIGURE 8-2, highlight each text box in the Calibrator section of the **Calibrate** tab and enter the correct information about a calibrator, enter the information and press **ENTER** to complete the entry.

When the calibration level, calibration frequency and calibrator description have been entered, highlight the **Save** button and press **ENTER** to save the information to the list of calibrators.

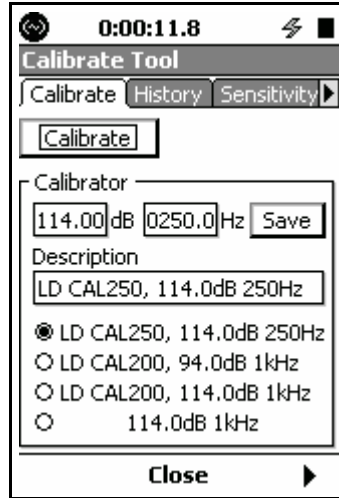

FIGURE 8-3 New Calibrator

If the desired calibrator is already in the list, select the calibrator and press **ENTER**. The calibration information will appear above.

Microphone Selection

Select the microphone to be used from the **Sensitivity** tab, as shown in FIGURE 8-2.

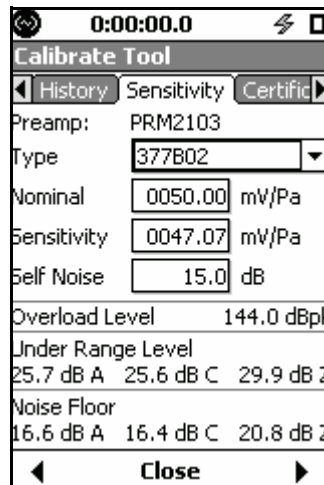

FIGURE 8-4 Sensitivity Tab

Larson Davis Microphone

The left side of the **Type** field is a text box, where manual text entries can be entered when it is selected (as shown in Figure 8-4).

In the **Type** field, highlight the down arrow and press **ENTER**. If using one of the Larson Davis microphones most frequently used with the Model 831, highlight the microphone listed and press **ENTER**, as shown in FIGURE 8-5

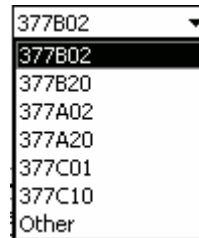

FIGURE 8-5 Microphone Selection List

The nominal value of sensitivity for that type of microphone will now appear in the Published data field. The **Self Noise** for that microphone and preamplifier combination will also appear in the **Self Noise** data field.

Other Microphone

*In order for the **Noise Floor** and **Under Range Levels** to be determined when the microphone is not selected from the drop down list as described in ‘Direct Data Input’ on page 8-14, the user must manually enter a value into the **Self Noise** data field.*

If using a microphone from another manufacturer, or if the Larson Davis microphone type being used does not appear in this list, highlight the left portion of the **Type** field and press **ENTER** to bring up the cursor. Enter descriptive text to define the microphone and press **ENTER** to accept the input.

Performing the Calibration

Refer to the calibrators operating instruction for more information.

Carefully insert the microphone into the microphone opening in the top of the calibrator. Turn on the calibrator.

Highlight the **Calibrate** button on the Model 831 and press **ENTER**, opening the calibrating display shown in FIGURE 8-6.

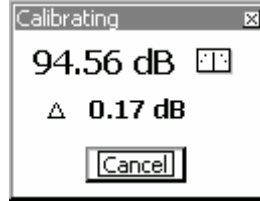

FIGURE 8-6 Calibrating

The present sound level (94.56 dB), the difference between the calibration level and the present sound level (Δ) and an indication of stability are displayed in this message box. When the pointer in the stability indicator is vertical, the sound level is stable.

The **Cancel** button is highlighted. Pressing **ENTER** will abort the calibration.

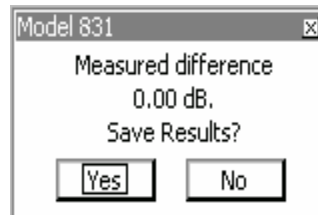

FIGURE 8-7 Save Calibration

*Calibrations must be saved if you plan to export post-calibration data or store them in history records. Alternatively, you can simply verify the calibration by selecting **No**.*

When the calibration is completed, a message box appears. Selecting **Yes** will save the results of the calibration and **No** will cancel the results of the calibration. Highlight the desired button and press **ENTER**.

Warning Messages

After selecting **Yes** to save the results of the calibration, there are two warning messages which may appear.

Outside Range of Normal Sensitivity

When the results of the calibration correspond to a sensitivity greater than 3 dB outside the range of the nominal sensitivity for that microphone, the message shown in FIGURE 8-8 appears.

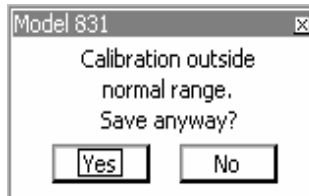

FIGURE 8-8 Outside Normal Sensitivity Range

When this message is received, it is advisable to scrutinize the current calibration sensitivity and overload level. Ensure that the calibration was performed properly and that all of the equipment is functioning correctly.

> 0.5 dB From Previous Calibration Result

When the results of the calibration indicate a change in sensitivity greater than 0.5 dB from the previous calibration results, the message shown in FIGURE 8-9 appears.

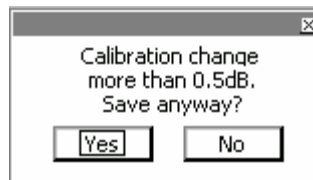
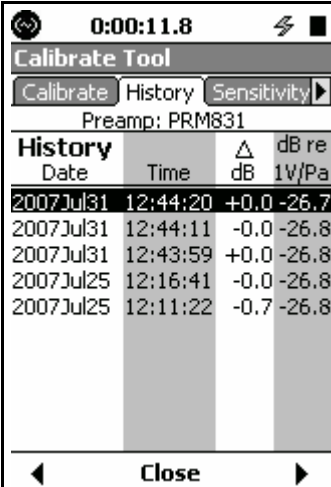

FIGURE 8-9 0.5 dB From Previous Calibration Result

Calibration History

The results of the last ten calibrations are displayed on the **History** tab, shown in FIGURE 8-10.



The screenshot shows a mobile application interface titled "Calibrate Tool". At the top, there is a status bar with a signal strength icon, the time "0:00:11.8", a battery icon, and a power icon. Below the title bar, there are three tabs: "Calibrate", "History", and "Sensitivity". The "History" tab is selected. Below the tabs, it says "Preamp: PRM831". The main content is a table with the following columns: "Date", "Time", "Δ dB", and "dB re 1V/Pa". The table contains five rows of data, with the first row highlighted in black. At the bottom of the screen, there is a "Close" button with left and right arrow icons.

Date	Time	Δ dB	dB re 1V/Pa
2007Jul31	12:44:20	+0.0	-26.7
2007Jul31	12:44:11	-0.0	-26.8
2007Jul31	12:43:59	+0.0	-26.8
2007Jul25	12:16:41	-0.0	-26.8
2007Jul25	12:11:22	-0.7	-26.8

FIGURE 8-10 Calibration History Tab

Here we see the date and time of each calibration, along with the sensitivity in dB re. 1 V/Pa and the difference between the level measured during the calibration and the level of the previous calibration.

Calibration Spectrum

The 831-OB3 option and 1/3 octave setting are automatically enabled (whether purchased or not) for acoustic calibrations and calibration checks so that spectra can be stored in history records and data files.

Press **ENTER** to display the spectrum of the highlighted calibration, as shown in FIGURE 8-11

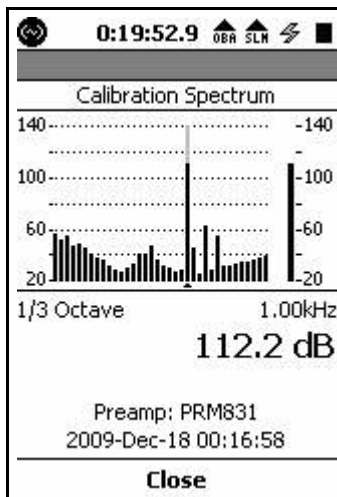

FIGURE 8-11 Calibration Spectrum Display

Sensitivity Tab

The **Sensitivity** tab, shown in FIGURE 8-12, is used primarily to establish the noise floor of the instrument with the preamplifier and microphone presently being used and, from that, determine the under range levels for A, C and Z-weighting sound level measurements. The overload level is also determined.

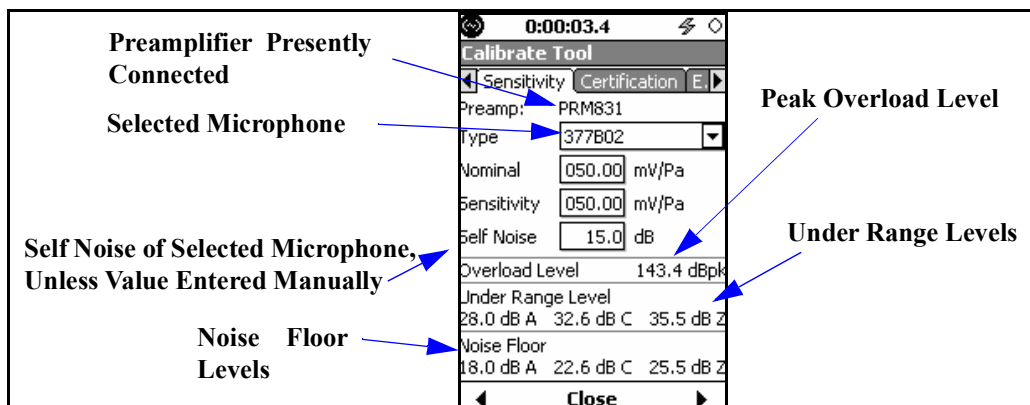

FIGURE 8-12 Sensitivity Tab

Noise Floor

The noise floor is calculated as the energy sum of the microphone self noise, preamplifier self noise and instrument self noise.

The appropriate noise floor, as well as the nominal sensitivity, is computed automatically in the Model 831 with the following preamplifiers and their commonly paired microphones:

- PRM 831
- PRM2103
- 426A12
- ICP with ADP074

When a calibration has been performed using any of the preamplifiers listed above, that calibration information is saved for that preamplifier. If the preamplifier is switched from one of these types to another, then the calibration information already saved for that new preamplifier type is recalled. As long as the same microphone is being used with that preamplifier, the calibration should be correct.

Direct Data Input

Self-noise values can also be entered manually when using preamplifiers and/or microphones not included in the Model 831 data base.

Overload Level

The overload level is the highest peak level which can be measured without overloading the input of the Model 831.

Under Range Level

The Under Range Level is the higher of the following:

- (1) Noise Floor plus 9.14 dB (under range shown when self noise contributes ≥ 0.5 dB to the readings).
- (2) Actual point where the log-linearity exceeds maximum permitted value

Except for very low noise level microphones, the under range level is usually determined by (1).

Calibration Without Preamplifier

There may be situations where the microphone preamplifier provided with the Model 831 is not being used. For example when a hydrophone is being used, no level calibrator is available so the sensitivity must be input directly by the user. When the preamplifier has been disconnected, the **Sensitivity** tab will appear as shown in FIGURE 8-13.

The screenshot shows a software window titled "Calibrate Tool" with a timer at "0:00:00.0" and a battery icon. The "Sensitivity" tab is selected, with "History" and "Certific" tabs also visible. The interface includes the following fields and values:

Preamp:	Direct
Type	Other
Nominal	050.00 mV/Pa
Sensitivity	050.00 mV/Pa
Self Noise	-20.0 dB
Overload Level	143.4 dBpk
Under Range Level	24.0 dB A 22.0 dB C 28.0 dB Z
Noise Floor	11.2 dB A 12.5 dB C 18.9 dB Z

At the bottom of the window is a "Close" button with left and right arrow icons.

FIGURE 8-13 Sensitivity Tab Without Preamplifier

In this situation, the sensitivity of the transducer and the self noise, if known, can be input directly.

Certification



FIGURE 8-14 Certification Tab

A certification interval of one year is recommended but this can be lengthened or disabled depending on applicable requirements.

The user has the opportunity to set the calibration interval and a calibration reminder.

Certification Tab Parameter Selection

The **Certification** tab parameters are selected as shown in FIGURE 8-15.

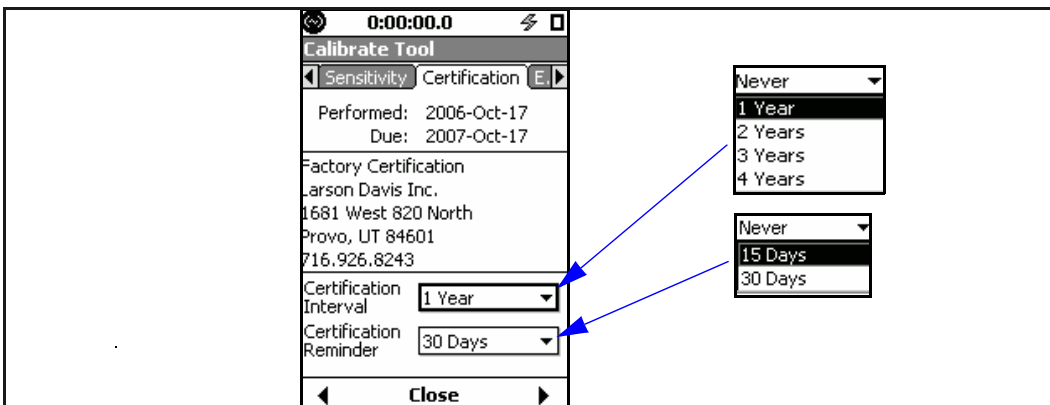

FIGURE 8-15 Certification Tab Parameter Selection

Available values of Certification Interval are as follows:

- 1 Year
- 2 Years
- 3 Years
- 4 Years
- Never

The default value is Never

Available values of Certification Reminder are as follows:

- 15 Days
- 30 Days
- 45 Days
- 60 Days
- Never

The default value is Never

Notification

When appropriate, the message “Certification will expire in xx days” or “Certification has expired” will be displayed as follows:

- When the instrument powers up
- When the Calibrate Tool is selected, as shown in FIGURE 8-1.

These messages will appear as shown in FIGURE 8-16 and FIGURE 8-17.

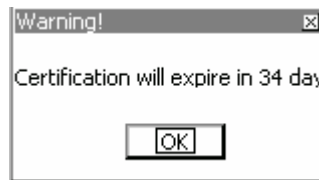

FIGURE 8-16 Message: Calibration will expire



FIGURE 8-17 Message: Calibration has expired

E.A. Check

When using a Larson Davis Model 426A12 Outdoor Preamplifier and Power Supply or Model 2100 Outdoor Preamplifier, this menu is used to perform a remote calibration check by switching on the electrostatic actuator (E.A.) contained within rain hat of the Model 426A12.

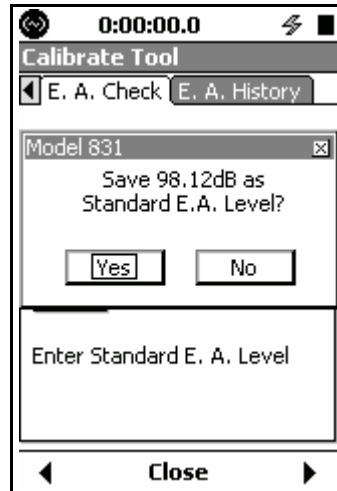

FIGURE 8-18 E.A. Check Menu

Initial Calibration

The sound pressure level produced by the E.A., typically in the range 94 to 96 dB, will depend upon the manner in which the rain hat is mounted upon the microphone, so it may change whenever removed and then replaced. However, once in place, it does generate a precision level that can be used to determine changes in the system calibration, whether in the microphone, instrumentation, cabling or in the Electrostatic Actuator itself. As a result, after installation of the rain hat, an initial calibration must be performed to establish the standard E.A. level. To do this, highlight **E.A**

Check and press **ENTER** to initiate a calibration, which will produce the display shown in FIGURE 8-19.

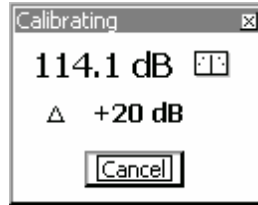

FIGURE 8-19 Calibrating In Progress Display

This display will indicate the difference between the present level and the previously measured level. When the measurement is complete, the display will be as shown in FIGURE 8-20

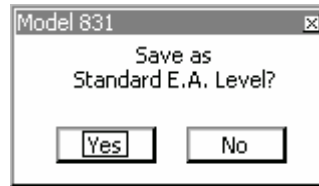

FIGURE 8-20 Save as Standard E.A. Display

For an initial calibration after replacing the rain hat, highlight **Yes** and pres **ENTER**, which will establish the level produced by this measurement as the Standard E.A. Level. This level will then appear in the E.A. Level box in the lower portion of the screen.

Calibration

Once the Standard E.A. Level has been established, as long as no changes have been made to the rain hat, follow the same procedure as for initial calibration. As long as the difference between the measured level and the Standard E.A. Level is acceptably small, this indicates the system is performing well. However, following a satisfactory calibration check, it is up to the individual user whether to select **Yes** or **No** to the Save as Standard E.A. Level inquiry. By selecting **Yes**, the Standard E.A. Level will change to follow the most recent calibration whereas selecting **No** will maintain the original Standard E.A. Level as the standard for comparison. All manual E.A.Checks that do not time-out will be stored in the calibration history, meaning that even if

No had been selected for the Save as Standard E.A. Level inquiry it will be saved.

Background Noise

If the measured level during calibration is not stable, the Model 831 will assume that there is contamination due to background noise and abort the calibration. Also, the E.A. calibration spectrum can be viewed to see if there was any significant out-of-band energy.

E.A. History

The last ten calibration E.A. calibration check levels are saved in a Check History. These are displayed on the **E.A. History** tab, shown in FIGURE 8-21,

During EA calibration the LDN is paused. The net result has no effect on the history data while the calibration tone is on.

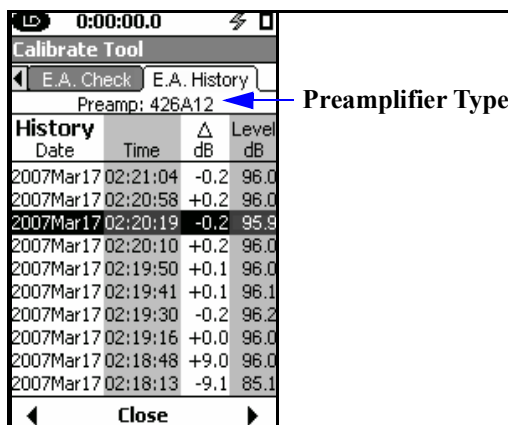

The screenshot shows the 'Calibrate Tool' interface with the 'E.A. History' tab selected. At the top, it displays 'Preamp: 426A12' with a blue arrow pointing to it from the label 'Preamplifier Type'. Below this is a table with the following data:

History		Δ	Level
Date	Time	dB	dB
2007Mar17	02:21:04	-0.2	96.0
2007Mar17	02:20:58	+0.2	96.0
2007Mar17	02:20:19	-0.2	95.9
2007Mar17	02:20:10	+0.2	96.0
2007Mar17	02:19:50	+0.1	96.0
2007Mar17	02:19:41	+0.1	96.1
2007Mar17	02:19:30	-0.2	96.2
2007Mar17	02:19:16	+0.0	96.0
2007Mar17	02:18:48	+9.0	96.0
2007Mar17	02:18:13	-9.1	85.1

At the bottom of the screen, there is a 'Close' button with left and right arrow icons.

FIGURE 8-21 E.A. History Tab

Note that E.A. History is only available when using either the 426A12 or PRM2100 Outdoor Preamplifier; as indicated in the upper section of the display.

The parameters for the most recent calibration appear at the top of the list. Both the absolute level measured and the difference from the Standard E.A. Level setting appear for each calibration, as well as the data and time of the calibration.

Industrial Hygiene

This chapter describes the measurement features associated with the Industrial Hygiene optional firmware 831-IH.

Measurement Setup

The Industrial Hygiene measurement features are setup from the Settings Screen, in the same manner as the basic measurement parameters are setup as described in Chapter 4 “Basic Measurement Setup” on page 4-1.

When this firmware is loaded, the **Dosimeter 1** and **Dosimeter 2** tabs appear, which are provided to permit the evaluation of two independent noise dose data sets. Other than being on separate pages, they are identical. The default values for **Dosimeter 1** tab parameters are shown in FIGURE 9-1.

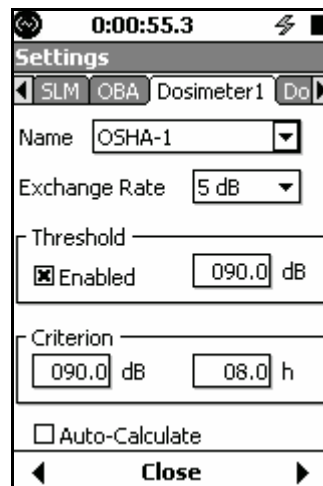

FIGURE 9-1 Dosimeter 1

Predefined Setups

In most cases, measurements of this type are setup to conform to a specific standard. The Model 831 permits the user to create such a setup in a single step by simply selecting the applicable standard. The standards addressed by the Model 831 and the corresponding parameters are as shown in Table 9-1 'Predefined Noise Dosimeter Setups'.

Standard	Exchange Rate	Threshold	Criterion	
			Level	Hours
OSHA-1	5	90	90	8
OSHA-2	5	80	90	8
ACGIH	3	80	85	8
NIOSH	3	80	85	8
IEC	3	Not Enabled	85	8

Table 9-1 Predefined Noise Dosimeter Setups

The Name field will already be highlighted when the Dosimeter 1 or Dosimeter 2 sections are opened. If this has been changed, use the 8 key to move the highlight back to the Name field.

The names of the predefined setups can be accessed from the Name field at the top of the display. Press the **ENTER** (ENTER) key to drop down a list of predefined setups by name as shown in FIGURE 9-2.



FIGURE 9-2 Predefined Dose Setups

Highlight the name of the desired setup and press **ENTER** to make the selection. The name of this setup will now appear in the Name field.

All parameters will be set according to the setup selected, as shown in FIGURE 9-3.

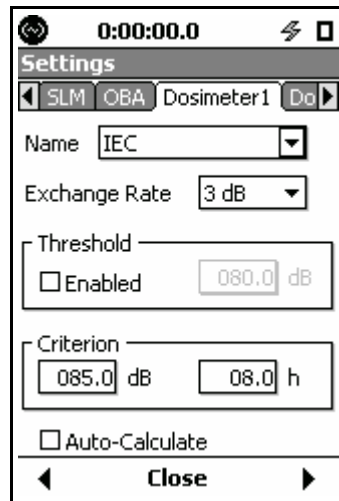

FIGURE 9-3 IEC Setup

Parameters Individually Defined

On the Dosimeter tabs, there are two fields (Name and Exchange Rate) and two sections (Threshold and Criterion).

Name Field

If a predefined setup has been selected and any of the preset parameters are modified, the user should consider changing the name of the setup.

The Name field is optional, although many users will enter text associated with the measurement to be performed such as a specific company Dose standard (“My Dose”) or the name of a standard not in the list. To enter a name, use the and keys to highlight the Name field. Use the key to highlight the name portion of the highlighted box; then press the key. Use the , , and keys to enter the desired characters. Press to complete your entry.

Parameter Fields

The titles of the second field (Exchange Rate) and the two sections at the lower portion of the display (Threshold and Criterion) correspond to the three parameters we wish to set. Within each is a numeric field into which the user can enter

the value desired. Highlight the desired section and proceed as described below.

Exchange Rate

To set the exchange rate, highlight the data field and press **ENTER** to open a drop down list of values, as shown in FIGURE 9-4 "Exchange Rate List" .

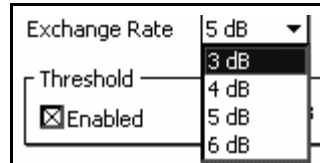

FIGURE 9-4 Exchange Rate List

Highlight the desired value and press **ENTER** to make the selection.

Threshold and Criterion

*Note that when setting the Threshold value, the Enabled check box must be checked before data can be entered into the numeric field. Use the Left Softkey to highlight the box and press **ENTER**.*

To set these parameters, highlight the appropriate section, press **ENTER**, enter the numeric value desired, then press **ENTER** again.

Auto-Calculate

As described above, the Criterion Level and Time are set independently. However, in the standards there is a linear relationship between the Criterion Level and the Time. When Auto-Calculate is activated, by checking the check box to the left, then only one of these need be entered and the other will be automatically set to follow the standard.

Data Display

The Industrial Hygiene measurement data are displayed on the **Overall** tab of the Data Display View, as are the results of the basic sound level measurements as described in Chapter 5 “Data Display” on page 5-1.

Four sections will appear: **Sound Exposure**, **Dosimeter 1**, **Dosimeter 2** and **SEA**. The two dosimeter displays will be identical except for the measurement values (if they had been setup with different measurement parameters). These four sections will be found just before the last section of the **Overall** tab.

Sound Exposure

Sound Exposure Level	
LAE	90.7 dB

Sound Exposure	
EA	130.1u Pa ² h
EA8	220.4m Pa ² h
EA40	1.1022 Pa ² h

EA	468.4m Pa ² s
EA8	793.60 Pa ² s
EA40	3968.0 Pa ² s

Run Time: 0:00:17.0

Menu

FIGURE 9-5 Overall Tab, Sound Exposure

The Sound Exposure page on the **Overall** tab shows sound exposure metrics (in this instance for A-weighted). L_{AE} is the sound exposure level (previously known as SEL). The Sound Exposure metrics indicate the actual and extrapolated (8 and 40 hours) exposure accumulated in terms of hours and seconds. These are discussed in "Difference between sound and noise: Sound is the physical phenomenon associated with acoustic (small) pressure waves. Use of the

word sound provides a neutral description of some acoustic event. Generally, noise is defined as unwanted sound. It can also be defined as sound that causes adverse effects on people such as hearing loss or annoyance. It can also be defined as the sound made by other people. In every case, use of the term noise involves someone's judgment. This often puts noise in the realm of psychology not physics." on page D-16 and "Sound Exposure Level (SEL, LE)" on page D-17.

Dosimeter 1 and 2

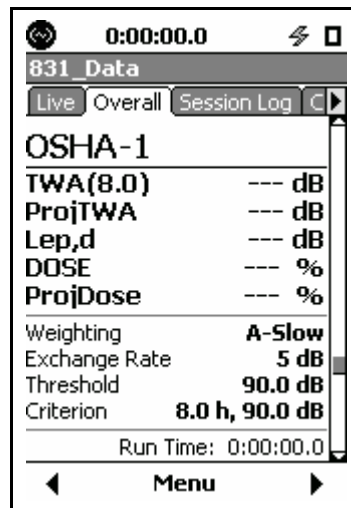

FIGURE 9-6 Dosimeter 1 Display

In this example, we can see that the measurement parameters correspond to the setup named "OSHA-1".

TWA(8.0)

The value of TWA(8.0) (Time Weighted Average for 8 hours) is based on data measured during the run time and calculated for the user-defined Criterion Time, in this case 8 hours. The value of Criterion Time is set by selecting a predefined setup as described in "Predefined Setups" on page 9-2 or by entering a numerical value as described in "Threshold and Criterion" on page 9-4.

As an example, suppose a measurement was performed over a time period of ten minutes. The value of TWA(8.0) would be the same as the TWA measured over an eight hour period if there had been no sound exposure other than that which occurred during that ten minute period.

ProjTWA

The ProjTWA (Projected Time Weighted Average) is calculated from data measured during the measurement run time and calculated without regard to the criterion time. Continuing with the example in the above paragraph, the ProjTWA for that ten minute measurement represents the value of TWA which would be measured if the noise measured during the ten minute period had continued for eight hours.

$L_{ep,d}$

The Daily Personal Noise Exposure, $L_{ep,d}$ is calculated from data measured during the run time of the measurement.

DOSE

Dose is based on data measured during the run time calculated for the user-defined Criterion Time and Criterion Level (100% definition). As an example, suppose a measurement was performed over a time period of ten minutes. The value of Dose would be the same as the Dose measured over an eight hour period if there had been no other sound exposure other than that which occurred during that ten minute period.

ProjDOSE

Projected Dose is based on data measured during the run time and calculated without regard to the criterion time. Continuing with the example in the above paragraph, the Projected Dose for that ten minute measurement represents the value of Dose which would be measured if the noise measured during the ten minute period had continued for eight hours.

The remainder of the display shows the parameters used for the measurement: Frequency Weighting, Exchange Rate, Threshold and Criterion (time and level).

SEA

The SEA parameter is used primarily in the Canadian province of Quebec.

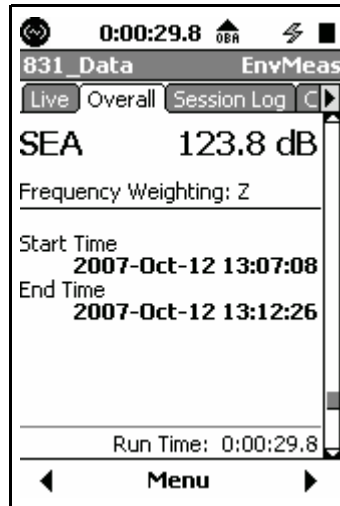

FIGURE 9-7 SEA Display

SEA is an integration of 1 second peaks that exceeded 120 dB. Both the SEA value and the frequency weighting used for the measurement are displayed.

Voice Recording

Control Panel - Voice Recording

Voice recordings are recorded using a sample rate of 8 kHz.



To activate the Voice Recorder Page, press the  (TOOLS) key and highlight the Voice Recorder icon as shown below.



FIGURE 10-1 Control Panel

Press the  (ENTER) key to open the Voice Recorder Page.

Press the **Close** Softkey to exit.

With Headset

When using a headset, the Jack Function must be set to Headset as described in the section “Jack Function” on page 18-13.

By connecting a headset to the headset jack on the bottom of the Model 831, voice records may be recorded using the headset microphone. Voice records may be played back through the headset speaker.

Without Headset

With no headset plugged in, a record may be made of the sound arriving at the measurement microphone.

Voice Recorder

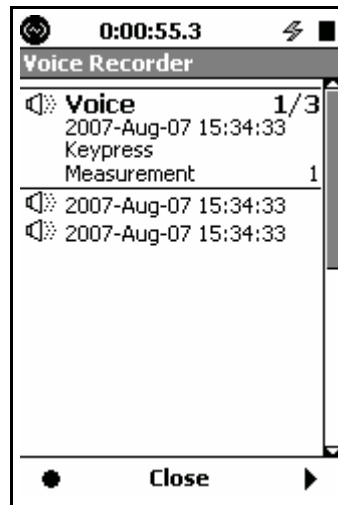



FIGURE 10-2 Voice Recorder Page

The  key can also be used to play the highlighted voice record.

The Voice Recorder page will present a list of existing voice records. Highlight a specific voice record and press the Right Softkey to play it back through a headset speaker. When measurement data are stored, all voice records that are shown on the list will be stored in the data file. The voice records list will then be empty.

Record

To begin a recording from the Voice Recorder Page, press the Left Softkey, just beneath the Record Icon.

Record Icon



The microphone level can be adjusted with the three position microphone switch found on the headset (ACC003).

The Recording message box will appear. The meter indicates the relative signal level from the recording microphone and the progress bar shows the elapsed time of the measurement. The progress bar length represents 25.6 seconds, which is the maximum time for a voice recording.



FIGURE 10-3 Recording

Press **ENTER** to stop recording if 25.6 seconds has not elapsed. At the end of 25.6 seconds, recording will stop automatically.

Save Prompt

When the recording has been stopped, the Save Prompt shown in FIGURE 10-4 will appear.



FIGURE 10-4 Save Recording Prompt

Select **Yes** to save the recording or **No** to close the recording session without saving the recording.

Playback

The **ENTER** key can also be used to play the highlighted voice record.

To playback a highlighted voice record, press the Right Softkey beneath the Playback Icon.

Playback Icon



Use the volume control on the headset (ACC003) to adjust the playback level.

With a headset attached to the headset jack on the bottom of the case, you will hear the voice recording in the headset speaker.



FIGURE 10-5 Playback

The meter indicates the relative amplitude of the recorded sound.

The progress bar indicates the elapsed time of the playback of the recording. The progress bar length represents the actual recording time.

Press **ENTER** to stop the playback.

At the end of the voice record, the playback will stop automatically.

Session Log Page

Voice recordings can also be played back from the Session Log Page, as described in “Voice Message/Sound Recording Playback” on page 5-27.

Time History

This chapter describes the measurement features associated with the optional data logging firmware 831-LOG and 831-FST.

Metrics Logged

Using the Time History mode, the Model 831 can automatically log a large number of metrics, or parameters, both acoustic and non-acoustic, at equal time intervals.

Available Time Intervals

831-LOG

When the Model 831 has the optional firmware 831-LOG enabled, the available range of intervals is from 20 milliseconds to 24 hours.

831-LOG and 831-FST

When the Model 831 has both the optional firmware 831-LOG and 831-FST enabled, the available range of intervals is from 2.5 milliseconds to 24 hours. For more detailed information, see "Increased Time Resolution" on page 11-2.

Available Metrics

Interval

When the user-selected time interval is ≥ 100 milliseconds, any or all of the metrics listed in the following sections will be measured and stored for each time increment.

When the user-selected time interval is ≤ 50 milliseconds, the only metrics which can be measured and stored are those shown in bold in the following sections.

Acoustical Metrics

Time Interval Values

These are integrated (L_{eq}), maximum (L_{peak} , L_{Smax} , L_{Fmax} , L_{Imax}) and minimum (L_{Smin} , L_{Fmin} , L_{Imin}) values evaluated for the time interval since the preceding sample. Separate values are determined for A, C and Z frequency weightings.

L_{Aeq} , L_{Apeak} , L_{ASmax} , L_{AFmax} , L_{AImax} , L_{ASmin} , L_{AFmin} ,
 L_{AImin}

L_{Ceq} , L_{Cpeak} , L_{CSmax} , L_{CFmax} , L_{CImax} , L_{CSmin} , L_{CFmin} ,
 L_{CImin}

L_{Zeq} , L_{Zpeak} , L_{ZSmax} , L_{ZFmax} , L_{ZImax} , L_{ZSmin} , L_{ZFmin} ,
 L_{ZImin}

Instantaneous Values

These are continuously varying sound levels, based on Slow (S), Fast (F) and Impulse (I) detectors and A, C and Z frequency weighting, measured at the each time interval.

L_{AS} , L_{AF} , L_{AI}

L_{CS} , L_{CF} , L_{CI}

L_{ZS} , L_{ZF} , L_{ZI}

Specialized Acoustic Metrics

L_{AFTim5} : Taktmaximal 5 (utilized in Germany) using A-weighting and Fast detector. This also requires selection from the Preferences page, "Takt Maximal Data" on page 18-14. The definition is shown in "Taktmaximal-5" on page D-21.

C-A weighted average level (L_{Ceq} - L_{Aeq}) and Impulsivity (L_{AImax} - L_{Aeq}).

The optional firmware 831-IH is required for these metrics to be measured.

L_{twa1} and L_{twa2} : time-weighted averages associated with Dose 1 and Dose 2 exchange rates and thresholds. See "Dosimeter 1 and 2" on page 9-6.

Increased Time Resolution

Tms Resolution

When the time history interval has been selected to be 500 ms or less, the user has the option of implementing increased time resolution, which will cause the time value to be

measured and saved with millisecond resolution. This is described in more detail in the section "Select Time History Metrics" on page 11-6.

1/1 and 1/3 Octave Spectra

The optional firmware 831-OB3 is required for these metrics to be measured.

When 1/1 and/or 1/3 octave analysis has been enabled in the setup, **Instantaneous Level, Leq, Lmax and Lmin** for 1/1 and 1/3 octave frequency bands will also be measured.

The time history Lmax will be a Bin Max when the time history period is less than 1 minute regardless of the Max Spectrum setting being set for **At Max**.

Non-Acoustical Metrics

From Model 831

Battery Level
External Power
Internal Temperature

From 426A12 Outdoor Microphone Preamplifier System

426A12 Outdoor Microphone System required. Internal Temperature
Internal Humidity

From PRM2103 Outdoor Microphone Preamplifier System

PRM2103 Outdoor Microphone Preamplifier System required. Internal Temperature
Internal Humidity

From External Transducers via the 831-INT Interface Unit

Wind Speed
Wind Gust Speed
Wind Direction
Temperature: Average, Max and Min Levels
Humidity: Average, Max and Min Levels

From SEN031 Weather Station

Wind Speed

Wind Gust Speed

Wind Gust Direction

Temperature: Average, Max and Min Levels

Humidity: Average, Max and Min Levels

Time History Setup

Setup time history on the **Time History** tab on the Measurement Setup View, as shown in Figure 11-1

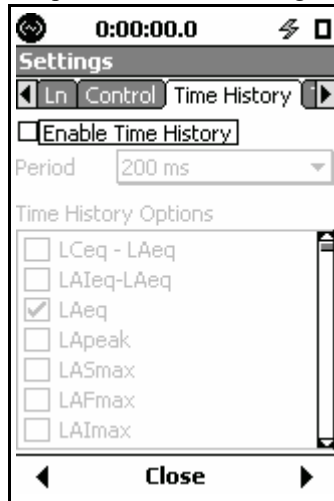

FIGURE 11-1 Time History Setup Menu

Press **ENTER** (ENTER) to enable the Time History functionality and to place a check in the Enable Time History check box. This will add additional items to the Time History setup

menu, as shown in FIGURE 11-2. Note that the default values for these parameters are as shown in FIGURE 11-2.

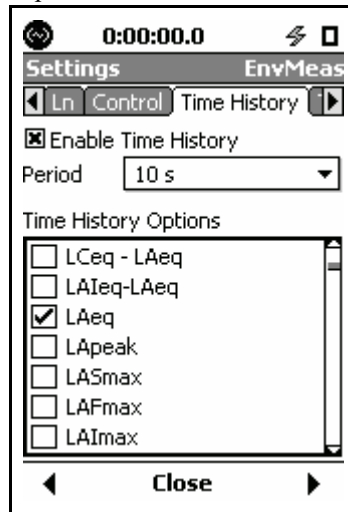



FIGURE 11-2 Time History Setup Menu: Enabled

Set Time History Period

To set the Time History Period, use the  key to highlight the Period data field and press  to list all the available values of time, as shown (partially) in Figure 11-3.

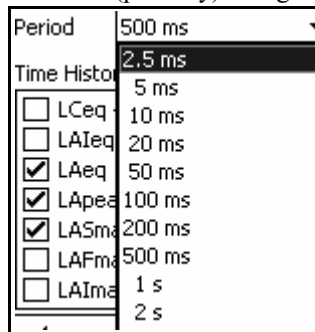

FIGURE 11-3 Time History Period Menu

The following values are available for selection as time increment for the Time History:

Note that the values 2.5 ms, 5 ms and 10 ms will only appear when the optional firmware 831-FST has been enabled. As you scroll downwards, when the highlight reaches the bottom of the window, the list will scroll upwards to reveal additional values.

Milliseconds

2.5, 5, 10, 20, 50, 100, 200, 500

Seconds

1, 2, 5, 10, 15, 20, 30

Minutes

1, 2, 5, 10, 15, 20, 30

Hours

1, 24

Highlight the desired increment of time and press  to make the selection.

Interval Time Sync

The setup to implement Interval Time Sync for both Time History and Measurement History is described in the section "Interval Time Sync" on page 12-2.

The interval time sync feature ensures that all measurement records, except the first, will begin at a time of day equal to a multiple of the measurement time selected. For example, if the measurement time is five minutes, and the measurement begins at 08:14:00 (h:m:s format), the first measurement will be cut short such that the subsequent measurements will begin at 08:15, 08:20, 08:25, etc.

Linear Integration Only

When the time history interval has been selected to be 10 ms or less, the integration method must be linear. If it is set to exponential when the time interval is set to one of these lower values, the message "Settings Conflict. Fix Automatically?" will appear. Reply **Yes** to change to linear and continue the setup process.

Select Time History Metrics

The metrics available for selection are described in "Metrics Logged" on page 11-1.

The Time History Options Menu is used to select, one-by-one, the metrics to be measured for each time increment. Highlight the Time History Options window and press .

Time History Increment > 10 ms

When the time increment selected is > 10 ms, the list of available metrics will appear as shown in Figure 11-4, with the first item in the options list highlighted.

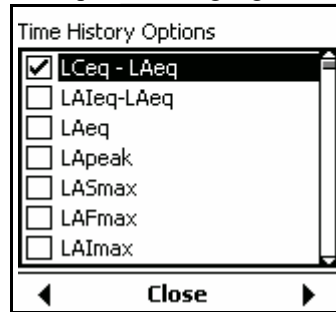

FIGURE 11-4 Time History Options Window: Time Increment > 10 ms

Tms Resolution

When $20 \text{ ms} \leq \text{Time Increment} \leq 500 \text{ ms}$ has been selected, the parameter Tms used to implement increased time resolution will appear at the bottom of the options list shown in FIGURE 11-4.

Note that spectrum metrics will only appear in the list when 1/1 octave and/or 1/3 octave have been selected. See "OBA Bandwidth Setting" on page 4-7 for details.

Highlight down or up, respectively, and use the \downarrow or \uparrow key to select an option and place a check in the check box. Use the same keys to deselect a box already checked.

Exiting Time History Options

When the options have been designated as desired, press ENTER to exit from the Time History Options Menu. You will then be able to display other tabs of the Measurement Setup Menu or exit from the Measurement Setup Menu by pressing the center softkey labeled **Close**.

Time History Increment ≤ 10 ms

When the selected time increment is ≤ 10 ms, the time history options window will appear as shown in FIGURE 11-5 .

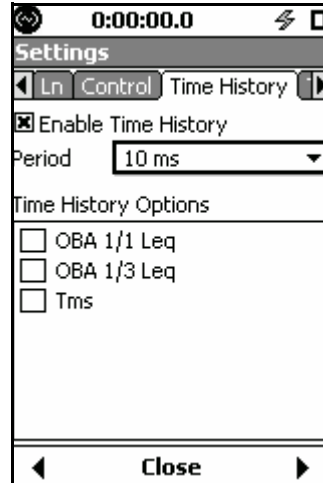

FIGURE 11-5 Time History Options Window: Time Increment ≤ 10 ms

When using such short time increments, the only parameters which can be stored are time history and Leq spectra. However, with this we can implement millisecond “display action”, Tms, which will time stamp the data with millisecond resolution.

To enable this feature, highlight the Time History Options section, press the **(ENTER)** key, highlight the Tms box and press **()** or **()** key to place a check mark and press **(ENTER)** once more.

When data is exported, the Tms data will appear in another column, separate from the normal time stamp data, allowing the use of Excel time and date formatting.

Time History Display

Single Value Metrics

When the Model 831 is not equipped with the optional firmware 831-OB3, or if it is equipped with this option but the measurement of 1/1 and 1/3 octave spectra has been set to Off in the measurement setup, all measured parameters will be single value parameters.

In this section we discuss the time history graph which appears for single value metrics such as sound levels and non-acoustic parameters.

Time History data is displayed on the **Time History** tab of the Data Display View as shown in Figure 11-6.

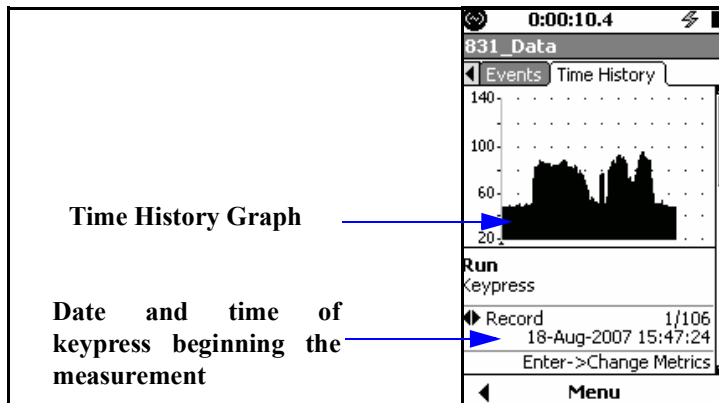

FIGURE 11-6 Time History Display: First Point; Keypress

Note that the graph scaling can be modified as described in section "Adjust Graph Scale" on page 5-29.

The initial graph on the **Time History** tab shows only 120 items from the time history at one time. There is no zoom in or out feature. Note that the cursor is located to the left of the graph and that there is no data digitally displayed. The label **Run** indicates that the cursor is not yet on a time point of the data set.

Data Display at Cursor Position

Holding down the left or right arrow keys will move the cursor faster as the key is held down longer. Holding the key accelerates movement through the time history.

The \leftarrow and \rightarrow keys are used to move the cursor right or left, respectively, in increments equal to the time history period. Press the \leftarrow key once to move the cursor to the location of the first time interval of the time history.

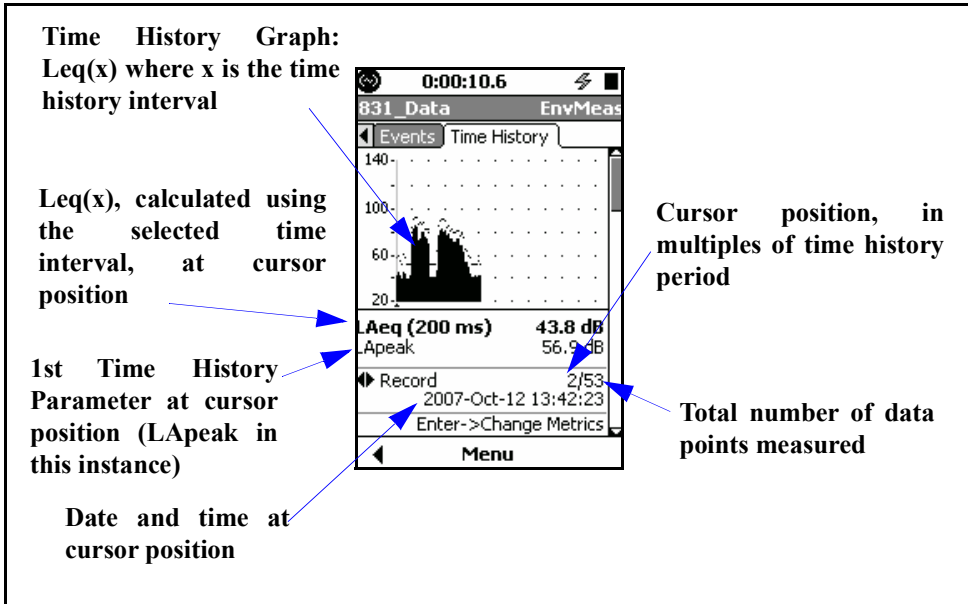

FIGURE 11-7 Measured Data at Cursor Position, First Parameter

Left/Right Arrow Keys

For the display shown in FIGURE 11-7, the \leftarrow and \rightarrow keys have dual roles as listed below. Press ENTER to toggle between them:

- Change Record
- Change Metrics (Measurement Parameters)

At any time, the role of the left and right arrow keys, as well as the means to change it, are indicated in the lower portion of the display, as shown in FIGURE 11-8.

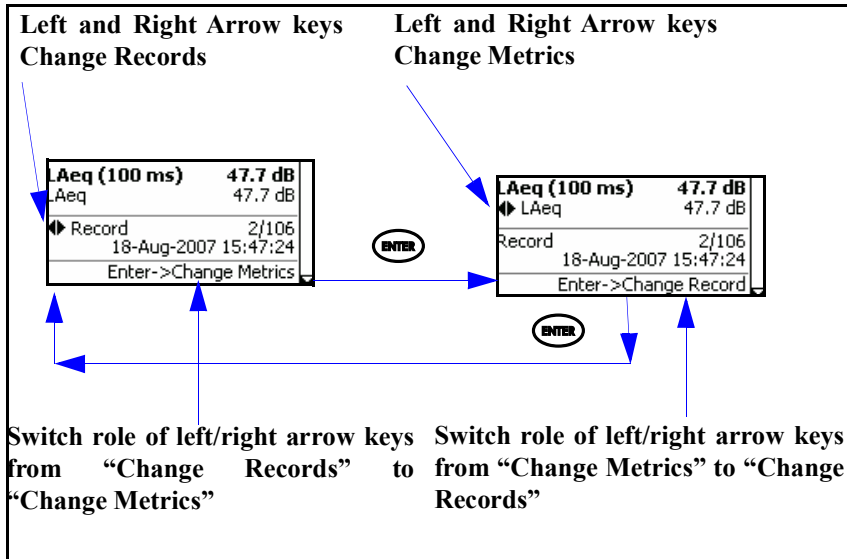

FIGURE 11-8 Role of Left/Right Arrow Keys: Time History Display

Locate Record Number

To jump to a specific record number, rather than step through the range of record numbers using the cursor, utilize the Locate Record Number feature, described in "Locate Record Number" on page 11-16

The time history graphs for Leq(x) and the selected time history parameter are overlaid on the display.

Change Metrics

As explained in section "Metrics Logged" on page 11-1, the user can select to log up to sixteen different parameters, or metrics, as a function of time, setup as described in section "Select Time History Metrics" on page 11-6. The default value is the first parameter selected during the setup procedure.

When repeatedly pressing the \diamond key, the logged metric values will be displayed in the same sequence as they

appeared in the list when selected, as described in "Select Time History Metrics" on page 11-6.

By pressing the \diamond and \diamond keys, the value displayed can be shifted to represent a metric one later or earlier, respectively, in sequence in the user-created list of metrics to log.

For example, in FIGURE 11-9 we have pressed the \diamond key to select LASmax, the next metric in the selection sequence, at the same cursor position used to graph and display Leq in FIGURE 11-7.

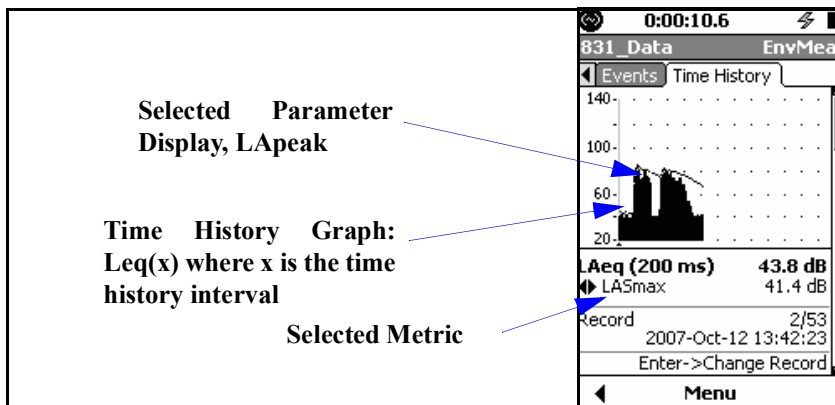

FIGURE 11-9 Time History Graph and Value of LASmax at Same Time

Frequency Spectra

When the Model 831 is equipped with the optional firmware 831-OB3 and either the 1/1 octave spectra or the 1/3 octave spectra, or both, have been selected for the measurement, then frequency spectra will appear in the list of metrics which can be logged.

When frequency spectra have been included in the list of metrics to be measured in the setup, as described in "1/1 and 1/3 Octave Spectra" on page 11-3, there will be additional displays as follows:

- **One additional display if all frequency spectra metrics are either 1/1 or 1/3 octave spectra.** Press the \cup key to show the spectrum display as shown in FIGURE 11-10.
- **Two additional displays if frequency spectra metrics include both 1/1 and 1/3 octave spectra.** Press the \cup key once to display metrics having the 1/1 octave format and press it a second time to display metrics having the 1/3 octave format

Except for the bandwidth, these displays are identical, so we will use a 1/3 octave spectrum as an example.

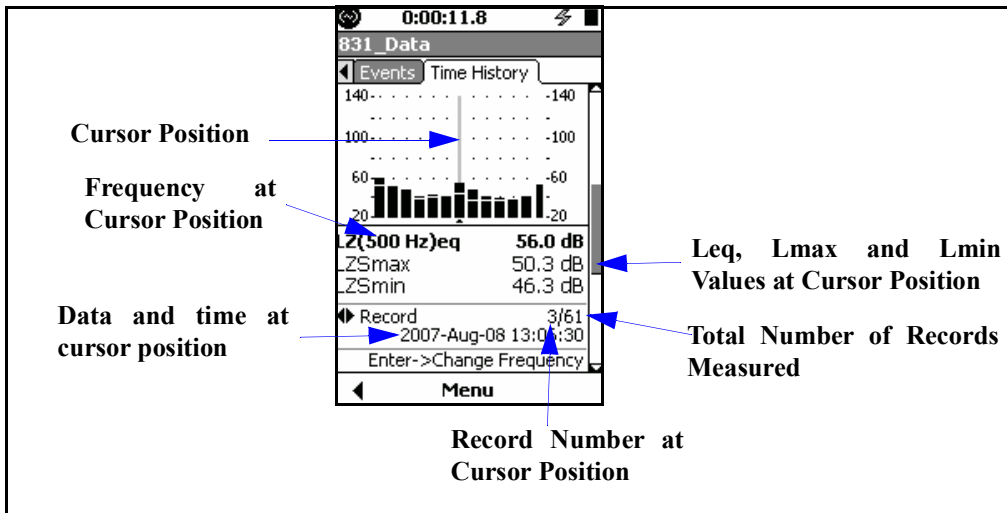

FIGURE 11-10 Time History Display: Spectra Metrics, Section 2 and 3

Left/Right Arrow Keys

For the display shown in FIGURE 11-10, the \leftarrow and \rightarrow keys have dual roles as listed below. Press ENTER to toggle between them:

- **Change Record:**
- **Change Frequency**

At any time, the role of the left and right arrow keys, as well as the means to change it, are indicated by the icon

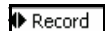

in the lower portion of the display, as shown in FIGURE 11-11.

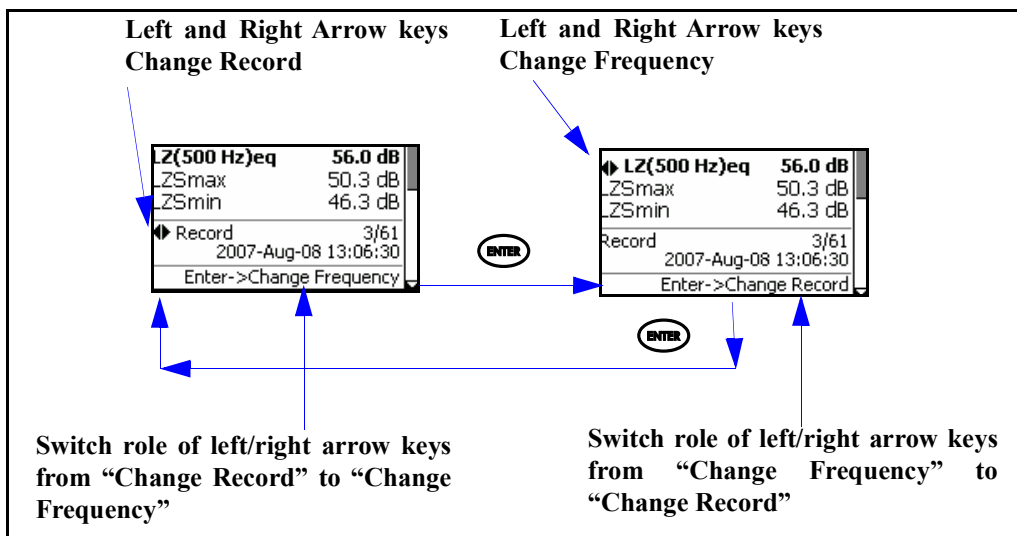



FIGURE 11-11 Role of Left/Right Arrow Keys: Frequency Spectra Display

Frequency Band Time History

From the frequency spectra display, press the  key to obtain the Frequency Band Time History display shown in FIGURE 11-12

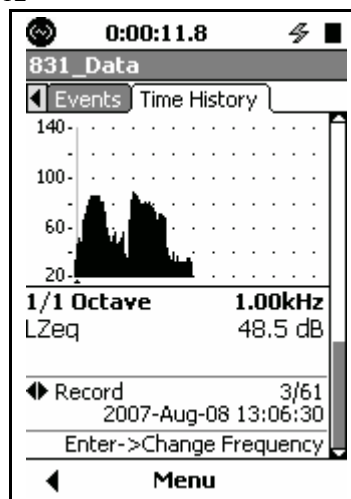

FIGURE 11-12 Frequency Band Time History Display

In this display, the time history of the LZeq level is shown at 1.00 kHz, the frequency of the cursor position used in frequency spectrum display shown in FIGURE 11-10 when changing to this display. Use the \leftarrow and \rightarrow keys to change the record number (time value).

Left/Right Arrow Keys

For the display shown in FIGURE 11-12, the \leftarrow and \rightarrow keys can have several roles as listed below. Use ENTER to toggle between them:

- **Change Record**
- **Change Frequency**
- **Change Metrics (Measurement Parameters)**

At any time, the role of the left and right arrow keys, as well as the means to change it, are indicated in the lower portion of the display, as shown in FIGURE 11-13.

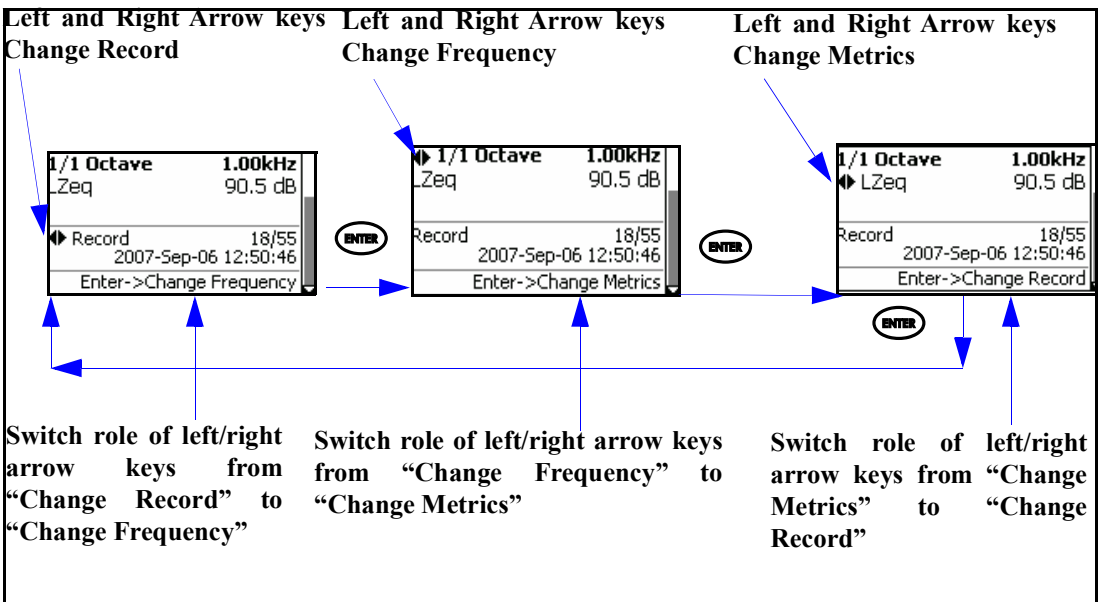

FIGURE 11-13 Role of Left/Right Arrow Keys: Frequency Band Time History

Locate Record Number

To rapidly change the record number, rather than use the cursor to step through the range of records, press the Menu softkey which will produce the display shown in FIGURE 11-17.

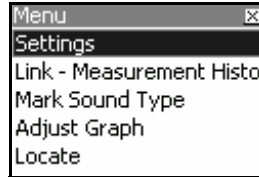

FIGURE 11-14 Locate Record Number

Highlight **Locate** and press **ENTER** to open the Locate Record Menu, shown in FIGURE 11-15.

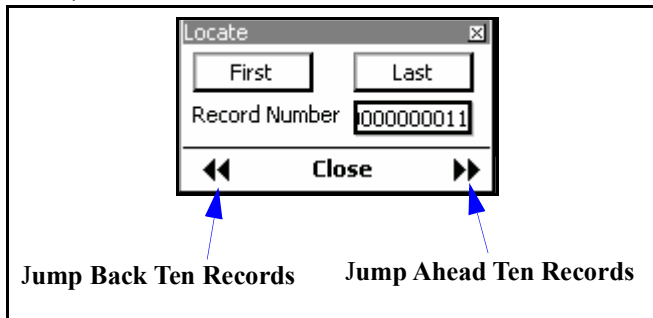

FIGURE 11-15 Locate Record Menu

Jump to First or Last Record

To jump to the first or last of the record numbers, highlight **First** or **Last**, respectively, and press **ENTER**.

Jump 10 Records Back or Ahead

To jump back or ahead ten records, highlight **Record Number** and press the left or right softkey, respectively, as indicated in FIGURE 11-15.

Locate a Specific Record

To locate a specific record, highlight the Record Number field and press **ENTER** to add a cursor to the Record Number field, as shown in FIGURE 11-16.



FIGURE 11-16 Record Number Cursor

Enter the desired record number using the **←** and **→** keys to move the cursor and the **⏏** and **⏏** keys to change the digits, then press **ENTER** to change the display to that record number.

Link to Measurement History Display

The major purpose of the Link to Measurement History is to locate the Measurement History record that applies to the same point in time as the current time history record. The inverse is also true; from the Measurement history you can Link to Time history, which will locate the Time History record with the time nearest the Measurement Time History.

To rapidly switch from a Time History display to a Measurement History display, press the Menu softkey which will produce the display shown in FIGURE 11-17.

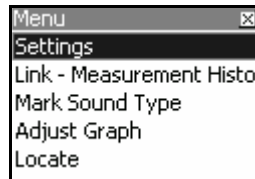

FIGURE 11-17 Link to Measurement History

Highlight **Link-Measurement History** and press **ENTER**.

Markers

Markers are used to annotate portions of the time history, especially for the purpose of identifying sound sources as they become dominant in the measurement. The Model 831 offers ten separate user-definable markers.

Markers Setup

Note that the default values for these parameters are as shown in FIGURE 11-18.

Markers are setup on the **Markers** tab in the Measurement Setup View, as shown in Figure 11-18.



FIGURE 11-18 Markers Setup 1-5

There are five markers with names predefined for convenience shown in this figure. Any of these names can be changed by the user. To view markers 6 -10, highlight the 6 - 10 text line and radio buttons and press **ENTER** to obtain the display shown in Figure 11-19.



FIGURE 11-19 Markers Setup 6-10

Naming a Marker

The process of naming markers is simplified by using the 831 Utility software.

Highlight the field of the marker to be named and press **ENTER**. This will produce a cursor which can be moved left and right to different digit positions in the data field using the **←** and **→** keys, as shown in Figure 11-20.



FIGURE 11-20 Marker Name Field

Enter a marker name and press the **ENTER** key to conclude the process.

Record with a Marker

The Record check box is available when the optional firmware 831-SR has been enabled. This will permit a sound recording snapshot to be made whenever the associated marker is activated. See "Marker Initiated Recording" on page 16-9 for more details.

Using Markers

The **Time History** tab of the Data Display View is used to display the data, as shown in FIGURE 11-6 “Time History Display: First Point; Keypress”.

After the measurement is begun, press the Menu key to bring up the display shown in Figure 11-21.

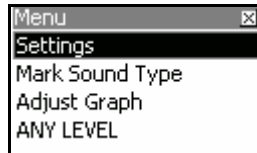

FIGURE 11-21 Menu Options

*Mark Sound Type is also available from the **Live Profile** and the **Session Log** display menus*

Highlight **Mark Sound Type** and press **ENTER**, which will bring up the Mark Sound Type dialog box as shown in Figure 11-22.

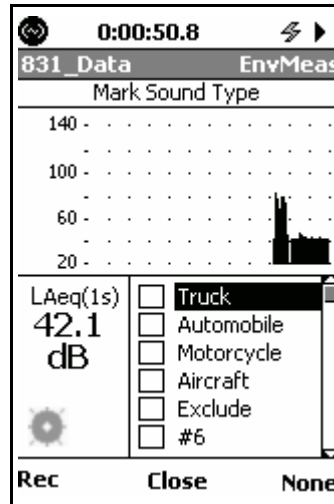

FIGURE 11-22 Time History Display with Markers

Setting Markers On/Off

At any time during a measurement, any of the markers can be set **On** or **Off**. The best way to enable or disable a marker is to press **ENTER**. The **↵** and **⏏** keys will turn the marker **On/Off** as well.

Setting All Markers Off

To set all markers to **Off**, press the right softkey labeled **None**.

Close Marker Control Window

Press the center softkey labeled **Close** to close the marker control window and return the display to the standard Time History display.

Markers on Time History Display

When any type of marker has been active during a time history measurement, this will be indicated by a solid horizontal line at the top of the screen as shown in "Marker Indication on Time History Display" on page 11-21.

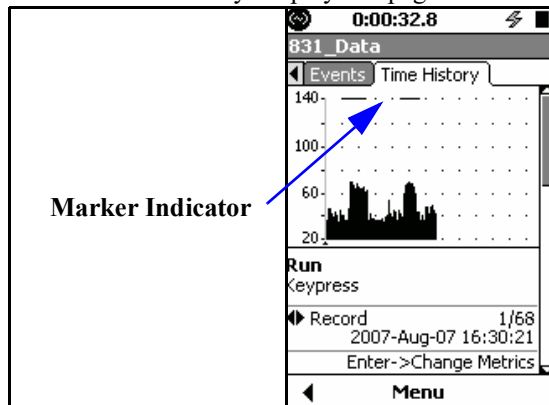

FIGURE 11-23 Marker Indication on Time History Display

The 831 Utility software provided with the Model 831 will show the names of the markers along with the time history data when the data is exported. See the 831 Utility User Manual for details.

Measurement History

Measurement History is used to perform a sequence of measurements using the same setup, either manually or automatically, which provide the same data as is obtained from the basic measurement, described in Chapter 5 “Data Display” on page 5-1. The optional firmware 831-ELA must be enabled to obtain the measurement history capability. This chapter presents a detailed description of the setup and use of the Measurement History feature and the data displays which it provides.

Run Control with Measurement History

Before working with Measurement History, review the setup of Run Modes, as described in Chapter 6,

*Please note, in the **Continuous**, **Single Block Timer**, and **Daily Timer** modes, setting a Measurement Time value of **00:00** (no time) will be saved as **00:01** (one minute) upon closing or exiting the **Control** tab.*

Measurement History is implemented from the **Control** tab of the Measurement Settings Screen by placing a check in the “Enable Measurement History” check box. When the Run Mode has been set to Continuous, this will produce a display as shown in FIGURE 12-1.

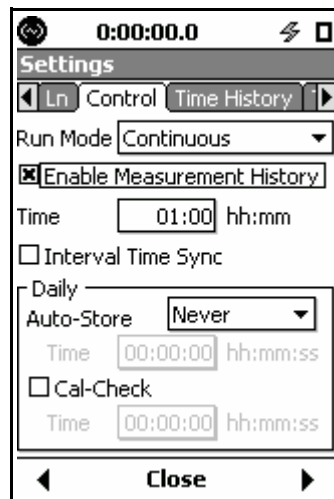

FIGURE 12-1 Measurement History Setup

Continuous and Timer Modes

For these run modes, when the Measurement History is enabled, a series of measurements will be performed and stored automatically, each running for a user-defined time interval. At the time the check mark is placed in the Measurement History check box to enable it, a window such as shown in Figure 12-2, will appear to define a time duration for each measurement.

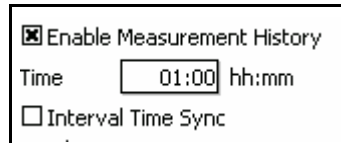

FIGURE 12-2 Measurement Time Menu

Note that the actual measurement duration may be shorter due to a manual stop, a timer stop or an autostore action.

Highlight the Time data field and press the **ENTER** (ENTER) key. Enter the desired value of time and press **ENTER** to conclude the process. The minimum permitted Interval Time is one minute; if a zero value is entered, the following message will appear.

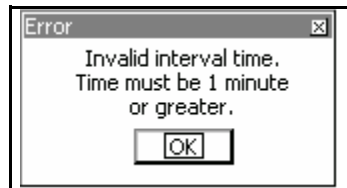

FIGURE 12-3 Invalid Time Warning

Interval Time Sync

The interval time sync feature ensures that all measurement records, except the first, will begin at a time of day equal to a multiple of the measurement time selected. For example, if the measurement time is five minutes, and the measurement begins at 08:14:00 (h:m:s format), the first measurement will be cut short such that the subsequent measurements will begin at 08:15, 08:20, 08:25, etc.

Valid Measurement Times

When other values are selected, the interval time sync will still function, but the time for which the first measurement is cut short will be different. See “Other Measurement Times” below for further detail.

The interval time sync function is intended to be used with the following measurement time values:

- 1, 5, 10, 20 or 30 minutes
- 1 hour

When the interval time sync function is used, each hour is divided into a number of equal time segments, based on the number of time intervals contained within one hour. For example, when the time interval is five minutes, there will be twelve segments within any one hour period beginning at xx:00:00, xx:05:00, xx:10:00, etc.

The instrument will begin the first measurement when the  (RUN/PAUSE) key is pressed. Regardless of the start time, when the clock of each instrument reaches the time corresponding to the beginning of the next segment, the measurement in progress will be stopped and stored, and a new measurement will be started.

Other Measurement Times

When values of measurement other than those listed above are used, the clock time at which the first measurement is cut short is based solely on the units of the measurement time; seconds, minutes or hours. For example, suppose the measurement time is set to three minutes. Based on the unit of minutes, the time intervals per hour are xx:00:00, xx:01:00, xx:02:00, etc. If the measurement were begun at 08:14:23, the first measurement would be cut short at the next measurement interval, so subsequent measurements would be started at 08:15:00, 08:18:00, 08:21:00, etc.

Timed Stop Mode

The Time Stop Mode with Measurement History has a feature not included for the other run modes; the ability to automatically measure and store a user-defined number of records, then stop. Subsequent runs, each manually initiated, will produce the same number of stored measurements.

Measurement Counter

When the Time is set to one minute or more for the Time Stop Mode, the Measurement Counter field will appear as shown in Figure 12-4.

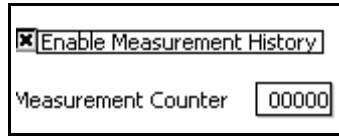

FIGURE 12-4 Measurement Counter

Measurement Counter is used to set the number of measurements to be made during each manually initiated measurement sequence.

Note that the measurement counter will be set to one and the selection field disabled when the measurement time has been set to less than one minute.

To enter the a value into the Measurement Counter field, time, highlight the Measurement Counter data field and press **ENTER**. Enter the desired value and press **ENTER** to conclude the process.

Example

The Continuous Mode, described in “Continuous and Timer Modes” on page 12-2, can be used to make an automatic Time History Measurement of a number of records, but the measurement process would need to be stopped manually when the desired number of records have been measured.



An example of the use of this would be when the user wishes to make a fixed number of separate measurements, each for the same run time, then stop. By setting the measurement counter to 4, for example, pressing the **▶/||** key would initiate a measurement sequence which would conclude when four measurements have been completed, each using the value of Run Time set as described in “Manual Stop, Timed Stop or Stop When Stable” on page 6-4.

This data is displayed on the Measurement **History** tab, as described in “Measurement Tab” on page 12-7, and can be saved by pressing the **■** (STOP) key.

Manual and Stop When Stable Modes

For these run modes, the Measurement History does not automate the measurement and storage of data as it does for the Continuous, Single Block Timer and Daily Timer modes. However, it does simplify the number of key presses required when making multiple measurements.

For these run modes, at the conclusion of a measurement, the data must be manually saved. Checking the “Enable Measurement History” checkbox does not add additional parameter fields to the display as it does with Continuous, Single Block Timer and Daily Timer modes.

With the Measurement History enabled, sequentially pressing the  and  keys will store the measurement and initiate another measurement, eliminating the need to perform a separate data store operation.

Display of Measurement History Data

*Note that the ANY LEVEL display of sound levels measured using all combinations of frequency weighting and time averaging can also be accessed from both the **Current** and the **Measurement** tabs. See “Any Level Display” on page 5-41.*

Measurement History data is displayed on the **Current** tab and the **Measurement** tab. These tabs are located to the right of the **Session Log** tab.

Current Tab

When the first measurement is in progress, the data will appear on the **Current** tab, the first section of which is shown in FIGURE 12-5.

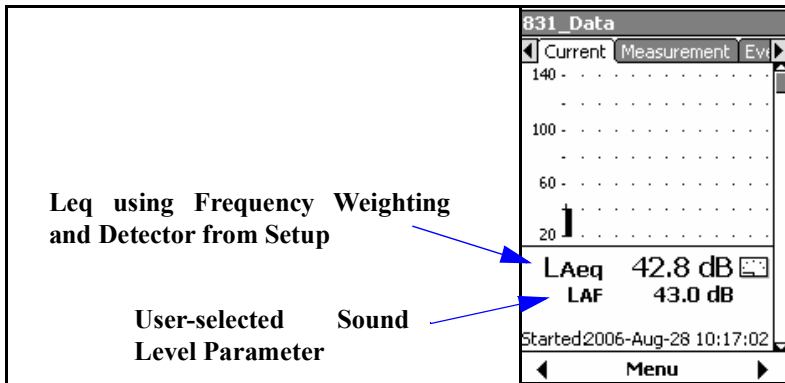



FIGURE 12-5 Time History Display: Current Tab

When that measurement is complete, its data will then be available for display on the **Measurement** tab. The **Current** tab is then reset and begins displaying data for the next measurement in progress. As a result, at any time the **Current** tab displays the measurement in progress.

*The **Current** tab also includes a page indicating the Remaining Leq.*

The **Current** tab can display as many as fourteen different data pages, depending on the firmware options enabled and the setup used. Press the  and  keys to navigate through these different pages. With the exception of the first page, these pages are similar to those displayed on the **Measurement** tab, as described in the next section. The main difference is that there is no reference to a record number.

On the first page, shown in FIGURE 12-5, the 1st numerical value displayed is Leq using the frequency weighting and detector from the setup. The 2nd numerical value displayed, L_{AF} in this example, is a user-selected parameter. This parameter is selected the same as for the Live SLM Display, described in “User-Selected SLM Parameter” on page 5-3.

Measurement Tab

The **Measurement** tab can display data for any one of the previously completed measurements. These measurement records are numbered in sequence from the first to the last. The data displayed in the first section of the **Measurement** tab is shown in Figure 12-6.

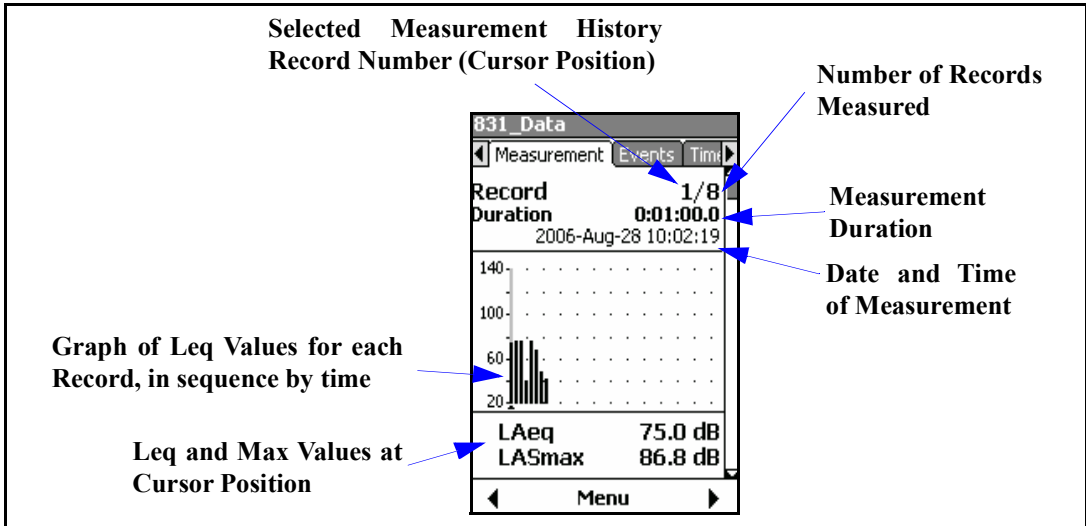



FIGURE 12-6 Measurement Record Display: Measurement Tab

During the first measurement, the same data will appear on the **Overall** and **Current** tabs. After that, the overall measurement will continue while new current measurements will be made as the measurement sequence proceeds.

Figure 12-6 shows the first page appearing on the **Measurement** tab. Figure 12-7 shows the pages that may appear on this tab, depending on the firmware options enabled and the setup used. Use the  and  keys to page sequentially through these different data displays. Table 3-1 lists these displays by name and indicates the position of that display in FIGURE 12-7.

Section	Display Type	Location in FIGURE 12-7	Comments
1	Measurement Record Display	Row 1 Column 1	See Figure 12-6 for detailed view.
2	Large Digit Display	Row 1 Column 2	

Table 3-1 Examples of Displays on Measurement Tabs

Section	Display Type	Location in FIGURE 12-7	Comments
3	Records Profile Display with Leq, L _{Smax} and L _{Smin}	Row 1 Column 3	See Figure 12-8 for detailed view
4	Max, Min and Peak Levels	Row 1 Column 4	
5	1/1 Octave Spectrum	Row 1 Column 4	Option 831-OB3 Required
6	1/3 Octave Spectrum	Row 2 Column 1	Option 831-OB3 Required
7	Ln Percentiles	Row 2 Column 2	If the user were to manually change the Ln values to be displayed during a measurement, as described in “Modifying Ln Values During a Measurement” on page 4-8, it should be noted that the Ln data presented for each record will correspond to the values selected at the time that record ends.
8	Spectral Ln	Row 2 Column 3	Option 831-OB3 Required
9	Exceedances	Row 2 Column 4	Option 831-ELA Required
10			
11			
12			
13			Overloads
14	Dose 2	Row 3 Column 4	Equivalent Levels
15	GPS	Row 3 Column 5	Sound Exposure
16	Weather	Row 4 Column 1	Dose 1

Table 3-1 Examples of Displays on Measurement Tabs

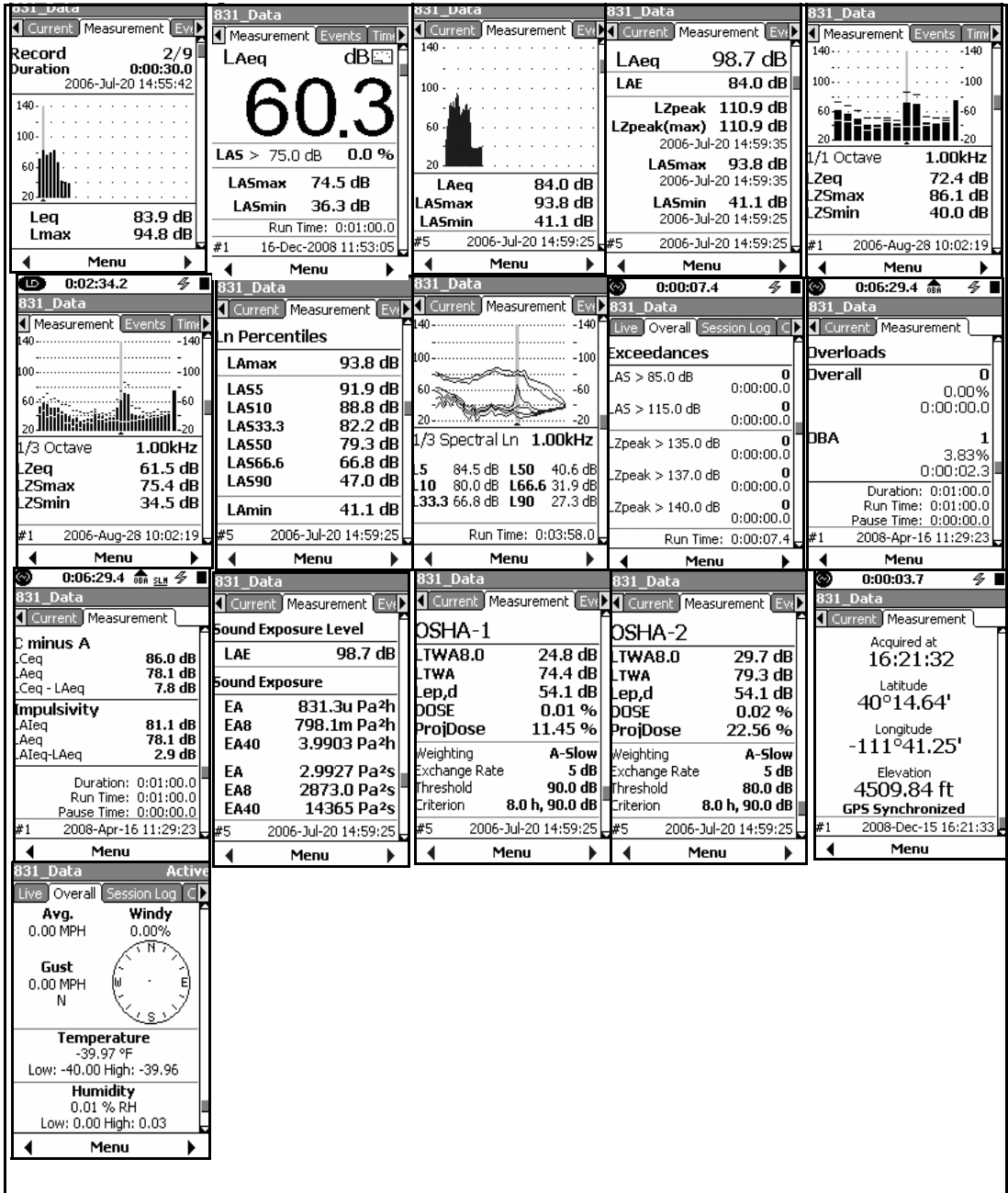

FIGURE 12-7 Measurement History Displays

Record Profile Display

There is no cursor on this graph nor a numerical display of amplitude or time.

The third section on the **Measurement** tab presents a Profile (Level versus Time) for the selected measurement record, as shown in FIGURE 12-8

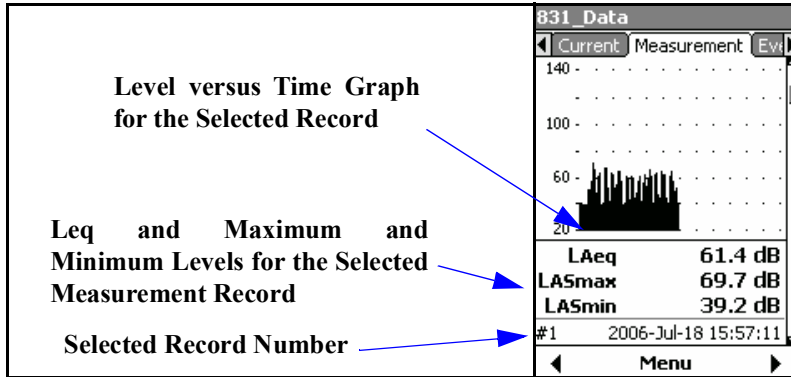

FIGURE 12-8 Profile Display: Measurement Tab

Equivalent Level Display

The Equivalent Level Display, shown in Figure 12-9, is a condensed version of the Community Noise display shown in Figure 5-23; the L_{den} and L_{dn} data do not appear in this display.

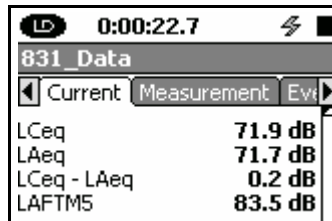

FIGURE 12-9 Equivalent Levels: Measurement Tab

Changing Displayed Record

For the Measurement Record Display, shown in Figure 12-6 on page 12-7, the selected record number for which data is being displayed is indicated at the upper right. For all other displays, the selected record number is indicated below the graph as shown in Figure 12-8 on page 12-10.

Non-Spectra Displays

With the exception of frequency spectra displays, the $\left\{ \right\}$ and $\left\{ \right\}$ keys are used to step the selected measurement record number up or down, respectively.

Frequency Spectra Displays

When a frequency spectrum is displayed, the $\left\{ \right\}$ and $\left\{ \right\}$ keys are used to move the cursor to the right and left, respectively, so that the levels can be displayed for different frequency bands. To change the displayed record, shift to a non-spectrum display to make the change then return to the frequency spectrum display.

Storing a Measurement History

Although the measurement history data can be displayed during a measurement and after it has been stopped, the data has not been stored to memory. To store the data, press the $\left\{ \right\}$ (Stop/Store) key.

Link to Time History

When Time History has also been enabled, a link is provided to make a rapid transition from any of the Measurement History displays to the same point in time of the Time History display. To implement this link, press the **Menu** softkey which will produce the display shown in FIGURE 12-10.

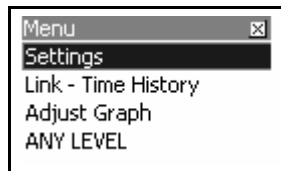

FIGURE 12-10 Link to Time History Display

Highlight Link-Time History and press ENTER to obtain the display shown in FIGURE 12-11.

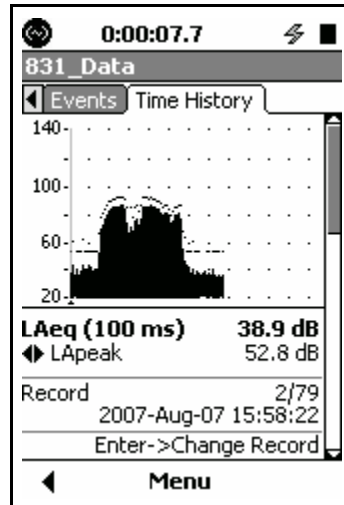

FIGURE 12-11 Time History Display

Event History

The optional firmware module 831-ELA is required in order to measure and store the metrics associated with exceedance events.

Level Based Events

Read “Triggers Tab” on page 4-11 prior to working with the Event History module.

Event History provides enhanced information on measured events defined by the user. Events are initiated and stored when the measured sound level exceeds the trigger levels **SPL1** and **Peak 1** for the specified minimum duration. **SPL1** and **Peak 1** are specified on the **Triggers** tab and the minimum duration is specified on the **Event History** tab.

Basic Measurement Data

When the basic measurement capability of the Model 831 is utilized, as described in the section “Triggering” on page 5-7, only a very limited set of data are saved for each threshold associated with the five trigger levels:

- The number of exceedances for each threshold level.
- The sum total of the time the measured level was above each threshold.

Event History Data

Event History provides a detailed record for each noise event including metrics such as:

- Date and time
- Duration
- Equivalent level (Leq)
- Maximum RMS and Peak levels
- 1/1 or 1/3 Octave Leq and max spectra (optional 831-OB3 firmware required)

Event History Setup

The Event History is setup on the **Event History** tab in the Measurement Settings Screen. If this is not already enabled, there will be nothing except an unchecked **Event History** check box.

The default values for these parameters are shown in FIGURE 13-1.

Press the **(ENTER)** key to place a check mark in the Event History check box and to enable the Event History. This will change the display to that shown in Figure 13-1.

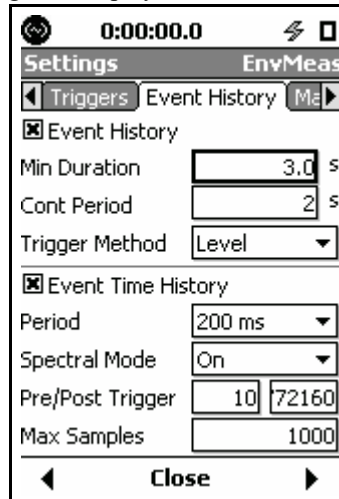

FIGURE 13-1 Event History Setup

Minimum Duration

Shorter duration noise events will still be counted as part of the basic measurement described in “Triggers Tab” on page 4-11, even though Event History data are not stored for them.

In situations where only noise events lasting longer than a certain time interval are of interest, the user can select a minimum duration requirement for the storage of noise events data. To set the minimum duration, highlight the Minimum Duration data field and press **(ENTER)**. Enter the desired values and press **(ENTER)**.

Note that the maximum permitted value of Minimum Duration is 9.9 seconds.

Continuation Period

Since each noise event is initiated when the sound level (SPL or Peak) exceeds a threshold level, one might define the end of the sound event at the instant both the SLM and

Peak levels drop below their threshold values. However, there may be situations where the sound level drops below the threshold for a short period of time before rising above it again, in which case the user may prefer to consider this a continuation of the event rather than the conclusion of the event and the beginning of another. This possibility is included by providing a user-defined Continuation Period.

Beginning when the levels both drop below their thresholds, if neither level rises above its respective threshold over a time interval equal to the continuation period, the noise event is considered complete. If, however, there is an exceedance of a threshold during the continuation period, the event is considered to be continued as if there had been no level drop below a threshold.

To set the Continuation Period, highlight the Continuation Period data field and press **ENTER**. Enter the desired value and press **ENTER**.

Trigger Method

There are two Trigger Methods provided.

- **Level:** in which an event is triggered when the measured sound level exceeds user-defined trigger levels.
- **Dynamic:** in which a single trigger level is utilized which tracks the background noise level.

Level Trigger Method

In the section “Triggers Tab” on page 4-11, it is explained how the Triggers Menu, shown in Figure 13-2, is used to set the parameters defining exceedance events.

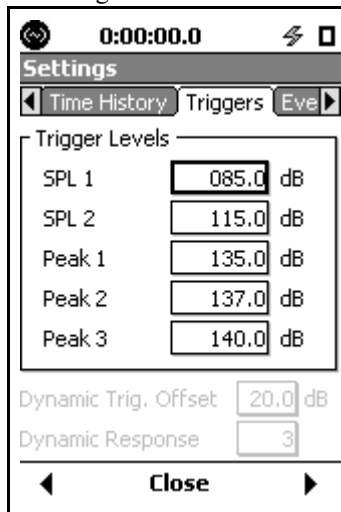

FIGURE 13-2 Triggers Menu

An exceedance event for which Event History data is measured and stored is initiated when either of the following occur:

- The SPL level (Fast, Slow or Impulse detector) exceeds the user-defined SPL 1 level
- The Peak level (Peak detector) exceeds the user-defined Peak 1 level

When the SPL level also exceeds the SPL 2 level, this is noted in the Events display of the **Overall** tab, as shown in FIGURE 5-21 "Overall Tab: Exceedances" on page 5-21.

When the Peak level also exceeds the Peak 2 level or the Peak 3 level (which should be higher than the Peak 2 level), this is noted on the **Exceedances** page of the **Overall** tab.

To select the Level Trigger Method, highlight the Trigger Method field and press **ENTER** to open the Trigger Method menu, shown in FIGURE 13-3.

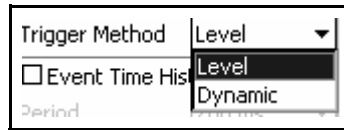

FIGURE 13-3 Trigger Method Menu

Highlight **Level** and press **ENTER** to implement the selection.

Dynamic Trigger Method

Dynamic triggering is a technique in which event triggering tracks the background level. This is implemented by making the event trigger levels equal to the background level plus an offset. The following example illustrates the value of this feature.

Barking Dog Example

During the day the sound of a barking dog may be masked by background noises such as passing cars, lawn mowers, etc. whereas during the night, when the background noise is lower, this would more likely be perceived as an annoyance.

Fixed Level Trigger

When performing unattended noise monitoring on a 24-hour basis using a fixed trigger level which is appropriate for capturing the higher level events, the dog barks would be missed since they are below the trigger level, as shown in FIGURE 13-4.

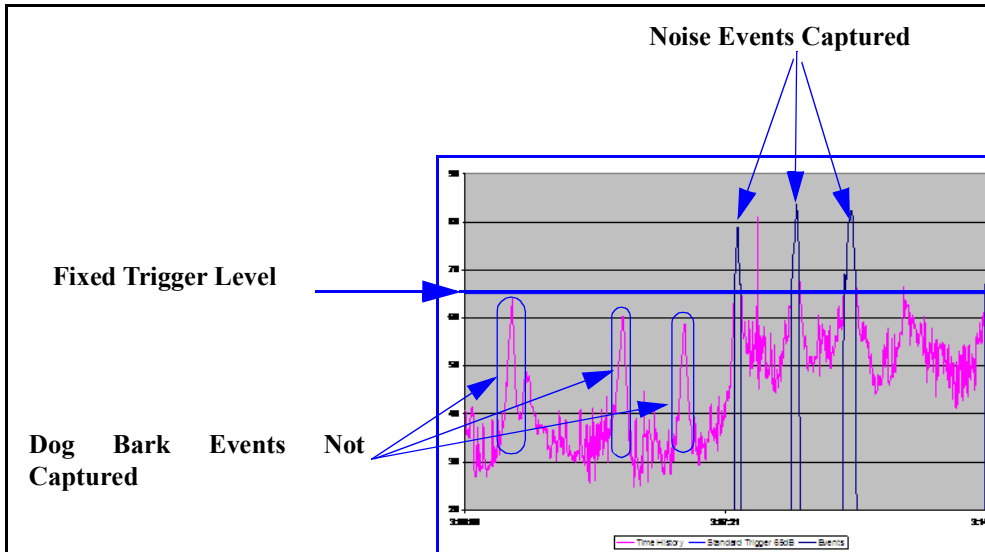

FIGURE 13-4 Fixed Level Trigger; Lower Level Events Missed

Dynamic Trigger

Using the dynamic trigger method, you can select to track the L_{90} level (background noise) and trigger a noise event when the measured level exceeds the L_{90} level plus an offset, which in this example we set to 15 dB. This permits the capture of lower level noise events which occur during periods of low background noise, as shown in FIGURE 13-5.

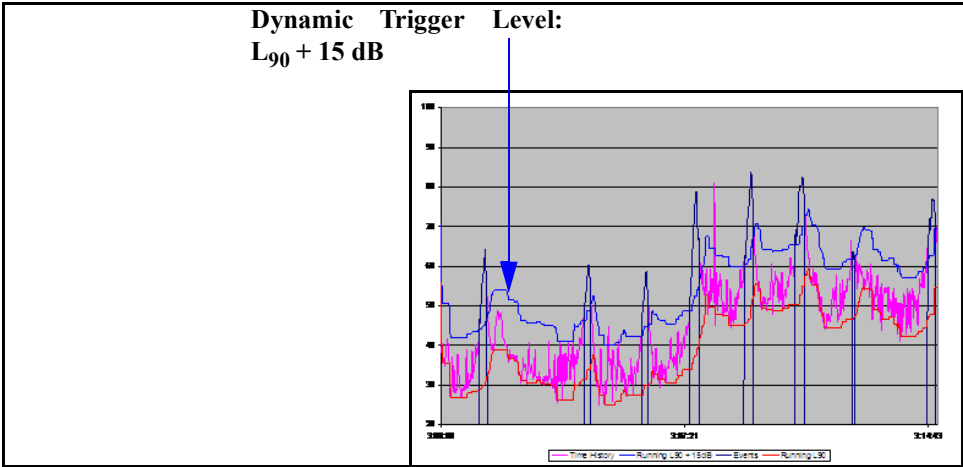

FIGURE 13-5 Dynamic Trigger: Lower Level Events Captured During Low Background Noise Periods

To select the Dynamic Trigger Method, highlight the Trigger Method field and press **ENTER** to open the Trigger Method menu, shown in FIGURE 13-6

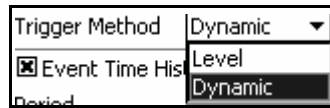

FIGURE 13-6 Trigger Method Menu

Highlight **Dynamic** and press **ENTER** to implement the selection.

Dynamic Trigger Parameters

After selecting the Dynamic Trigger Method, it is necessary to return to the **Triggers** tab, shown in FIGURE 13-7, by pressing the left softkey

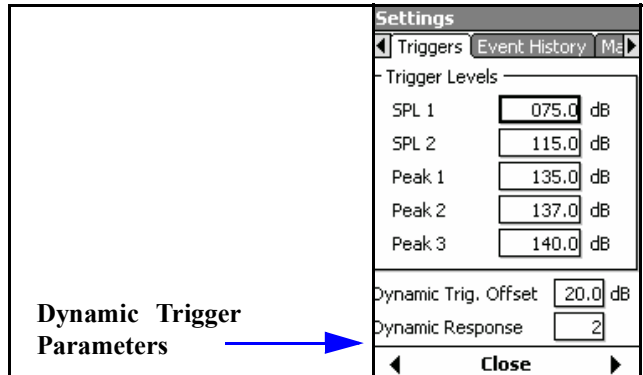

FIGURE 13-7 Triggers Menu: Dynamic Triggering

The **Triggers** tab now includes the dynamic triggering parameter fields Dynamic Trigger and Dynamic Response, which did not appear when Level Triggering had been selected, as seen in FIGURE 13-2.

When dynamic triggering is used, an event will be initiated when the measured sound level exceeds the Dynamic Trigger Offset plus the background level and it will conclude when the level drops below the Dynamic Trigger Offset plus the background level.

Dynamic Trigger Offset

To set the Dynamic Trigger Offset, highlight the Dynamic Trigger Offset data field and press **ENTER**.

Enter the desired values and press **ENTER**.

Dynamic Response

The background sound level used with dynamic triggering is a user-selected Ln level, calculated using an algorithm which includes the rise rate in dB per minute. There are five

options available, having the characteristics presented in TABLE 13-1.

Setting Number	Tracking Ln Percentile	Rise Rate, dB/minute	Description
1	95%	0.5	Lower Tracking Level
2	90%	1/3	Slower
3	90%	0.5	Default, Normal Operation
4	90%	1	Faster
5	80%	1	Faster and Higher Tracking Level

TABLE 13-1 Dynamic Response: Dynamic Triggering

To set the Dynamic Response, highlight the Dynamic Response data field and press **ENTER**. Set the digit to a value between 1 and 5 and press **ENTER**.

Dynamic Trigger Example

Suppose the dynamic trigger was set with the following parameters:

SPL1: 65 dB

Dynamic Trigger Offset: 20 dB

Dynamic Response: 3 (Tracking Ln Percentile = 90% and Rise Rate = 0.5 dB/minute)

The initial background tracking level is set at SPL Trigger Level 1 minus the offset setting.

When the measurement is first begun, the background tracking level is set to Trigger Level SPL1 minus the offset setting. In this situation, the tracking level would then be $65 - 20 = 45$ dB. The initial event trigger level would then be $45 + 20 = 65$ dB.

As the measured sound increases above the tracking level, the tracking level will increase at the rise rate. Conversely as the measured sound decreases below the current tracking level, the tracking level will decrease at the rate determined by the tracking Ln percentile and its corresponding rate.

The limitation to this increase in the event trigger level would be that the rate of increase in the value of Ln used to determine the event trigger level would be limited to a maximum of 0.5 dB/minutes. Thus, a rapid change in the value of calculated Ln of say several dB would not produce an immediate change in the event trigger level.

Event Time History Setup

When Event Time History has been enabled, time history data will be measured as a part of each event history.

Note that the default values for these parameters are as shown in FIGURE 13-8.

Highlight the Event Time History check box and press **ENTER** to enable it and place a check in the check box. This will produce the Event Time History Setup menu shown in FIGURE 13-8.

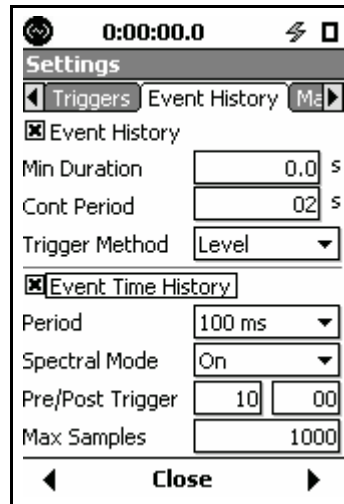

FIGURE 13-8 Event Time History Setup Menu

Period

Period defines the time period of each time history sample, which is the inverse of the sample rate. Highlight the Period data field and press **ENTER** to obtain the Period menu, shown in FIGURE 13-9.

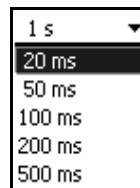

FIGURE 13-9 Event Time History Period Menu

The available choices are as follows:

Milliseconds

20, 50, 100, 200, 500

Seconds

1, 2, 5, 10

Highlight the desired Period value and press **ENTER** to make a selection.

Spectral Mode

A Spectral Time History can be measured for each event by setting Spectral Mode to **On**. The bandwidth of the Spectral Time History is either 1/1 or 1/3 octave, depending on the OBA bandwidth selected, as shown below.

- **1/1 Octave:** Spectral Mode is 1/1 Octave
- **1/3 Octave or 1/1, 1/3 Octave:** Spectral Mode is 1/3 Octave

Highlight the Spectral Mode data field and press **ENTER** to obtain the Spectral Mode menu, shown in FIGURE 13-10.

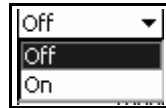

FIGURE 13-10 Event Time History Spectral Mode Menu

Highlight **On** or **Off** and press **ENTER** to make a selection. Setting the spectral mode **Off** will reduce the memory used for data storage.

Pre/Post Trigger

Pre-trigger is used when it is desired that the event time history include samples which occurred prior to the event threshold exceedance triggering the event and post-trigger is used when it is desired that the event time history include samples which occurred after the end of the event. Both can be enabled at the same time.

Pre-trigger

To set the number of pre-trigger samples, highlight the Pre-trigger data field and press **ENTER**. Enter the desired value and press **ENTER**.

Post-trigger

To set the number of post-trigger samples, highlight the Post-trigger data field and press **ENTER**. Enter the desired value and press **ENTER**.

Maximum Number of Samples

To limit the amount of memory used by event time histories, the user can specify the maximum number of samples to be measured for each event. The permitted range for this parameter is 10 to 9,999, with the default value being 1,000. This does not include pre-trigger samples, so the actual number of samples stored will equal the maximum number of samples plus the number of pre-trigger samples.

Event History Display

Event History data are displayed on the **Events** tab. There can be as many as six different sections to the Event History Display, depending upon the instrument setup. Use the 2 and 8 keys to navigate downwards or upwards, respectively, through these displays. The first section is the Event Trigger Status Display, shown in FIGURE 13-11.

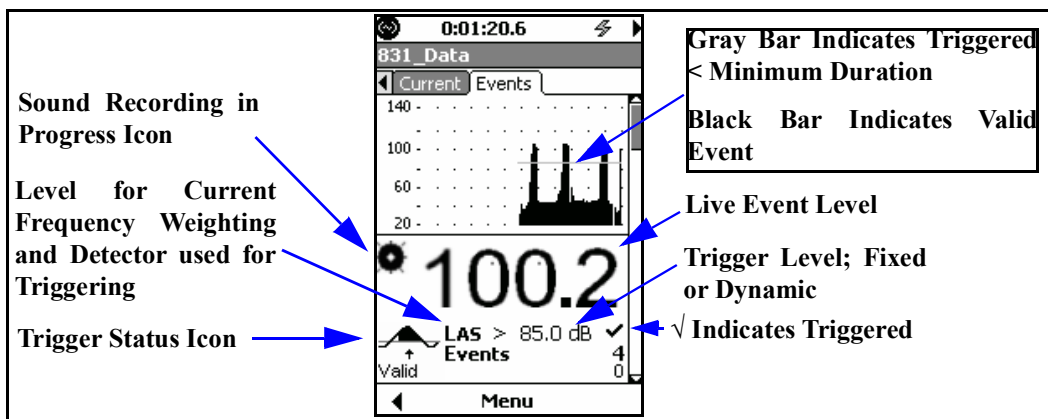



FIGURE 13-11 Event Trigger Status Display

Trigger Status Icons

The Model 831 begins sampling data as soon as the  (Run/Pause) key is pressed. The trigger status is indicated by one of five Trigger Status icons as described below.

Pre-Trigger



Pre-trigger is being collected but there are fewer samples than the pre-trigger samples setting. When enough samples have been collected the Ready state is activated. It is possible to transition to the Triggered state before the pre-trigger buffer is full.

Ready



The Ready state has all the pre-trigger samples needed and is waiting for an event to occur.

Triggered



When the level exceeds the trigger level the triggered state is entered.

Valid



When the level has exceeded the trigger level for longer than the minimum duration the Valid state is entered. At this point we have a valid event record.

Continuation



When the level no longer exceeds the trigger level we enter the Con? state where we wait for the continuation time in preparation to end the event. We continue processing event data and transition back to the Valid state if the level exceeds the trigger level during the continuation time.

Typical Icon Sequence

In a typical measurement, these icons will appear sequentially in the order presented above as the event measurement proceeds from the period prior to an event to the conclusion of the event.

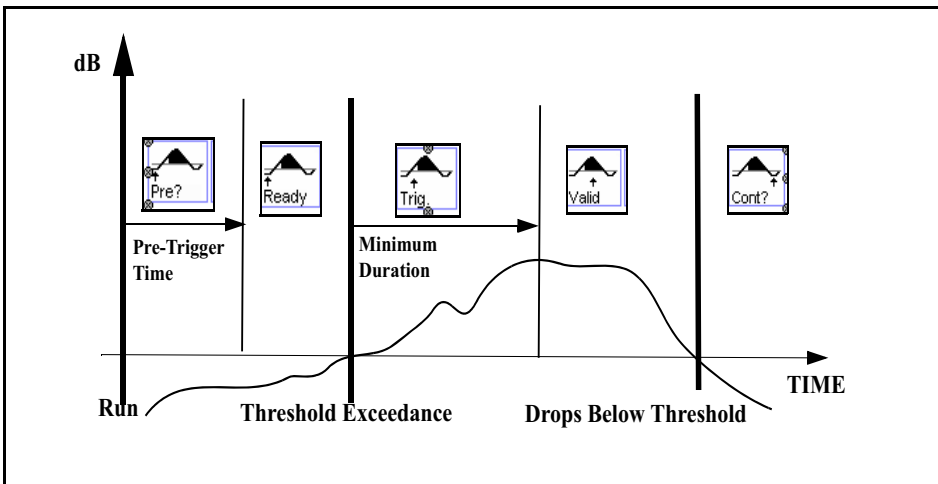

FIGURE 13-12 Typical Icon Sequence

Sound Recording in Progress

When automatic event sound recording has been enabled, as described in "Event Sound Recording" on page 16-14, the Sound Recording in Progress icon will be illuminated whenever a sound recording is being made. This icon is grayed out when no recording is taking place.

Levels Display

The second section is the Levels Display, which is shown in Figure 13-13.

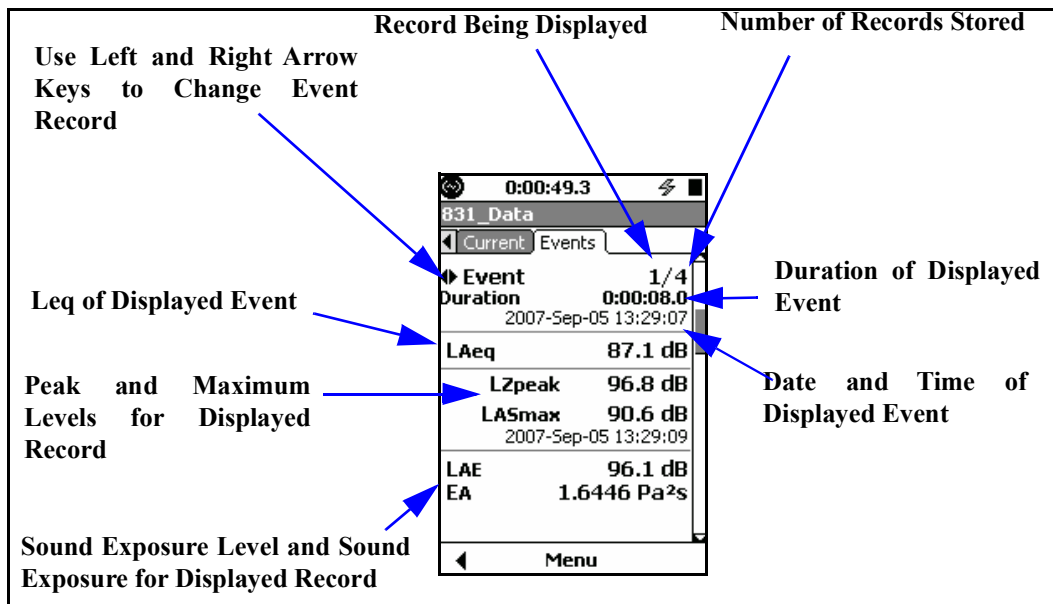

FIGURE 13-13 Event History: Levels Display, Section 2

Changing the Displayed Event Record

Event history records are stored sequentially in time, beginning with record 1. The Levels Display shown above presents data for the 1st of 4 events. Use the \leftarrow and \rightarrow keys to navigate backward or forward, respectively, through the stored records.

1/1 Octave Spectrum Display

With all possibilities included, the 3rd display would be a 1/1 octave spectrum for the displayed event, as shown in FIGURE 13-14

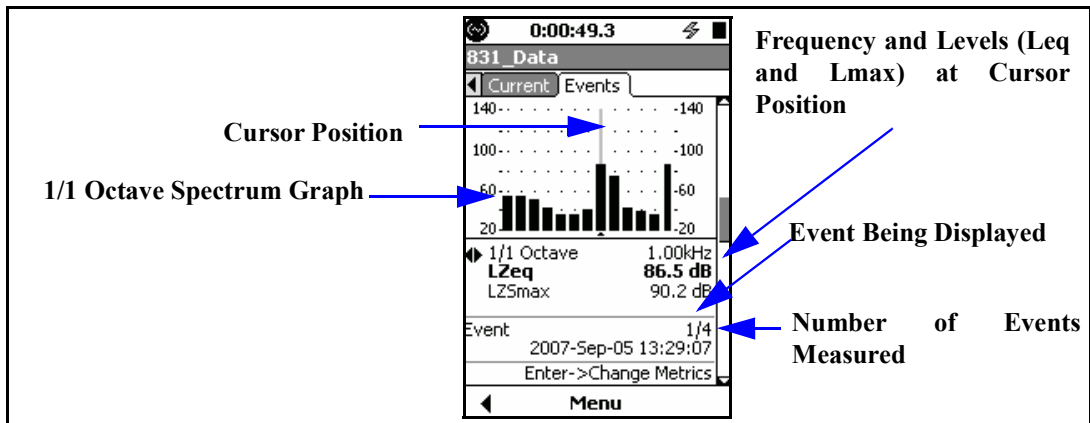

FIGURE 13-14 Event History: 1/1 Octave Display, Section 3

Left/Right Arrow Keys

For the display shown in FIGURE 13-14, the \leftarrow and \rightarrow arrow keys can serve three different purposes as listed below. Use ENTER to toggle between them:

- **Change Frequency**
- **Toggle between display of L_{ZSmax} and L_{AE}**
- **Change Event**

At any time, the role of the left and right arrow keys is indicated by the left/right arrow icon.



Press ENTER to change the role, as indicated in the lower portions of the display, and as shown in FIGURE 13-15.

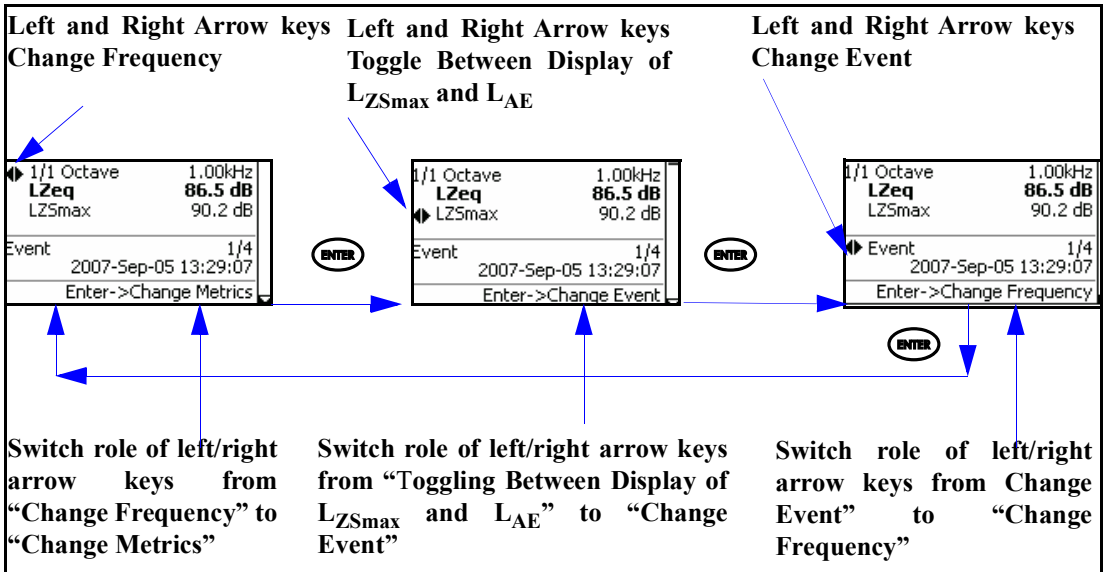

FIGURE 13-15 Role of Left/Right Arrow Keys: 1/1 Octave Spectrum

1/3 Octave Spectrum Display

With all possibilities included, the fourth display would be a 1/3 octave spectrum for the displayed event, as shown in FIGURE 13-16.

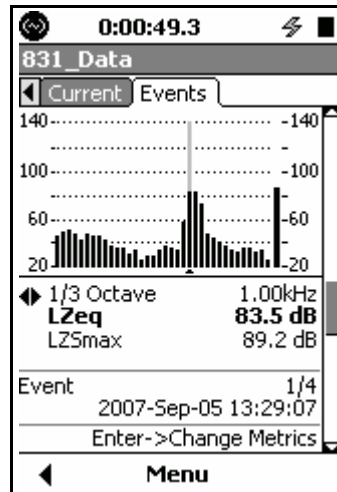

FIGURE 13-16 Event History: 1/3 Octave Display, Section 4

Except for the difference in frequency resolution, the data displayed and the use of the left and right arrow keys to control the cursor position and to step through the events are the same as for the 1/1 Octave display described in “1/1 Octave Spectrum Display” on page 13-16

Event Time History Display

With all possibilities included, the fifth display would be a Time History for the displayed event, as shown in FIGURE 13-17.

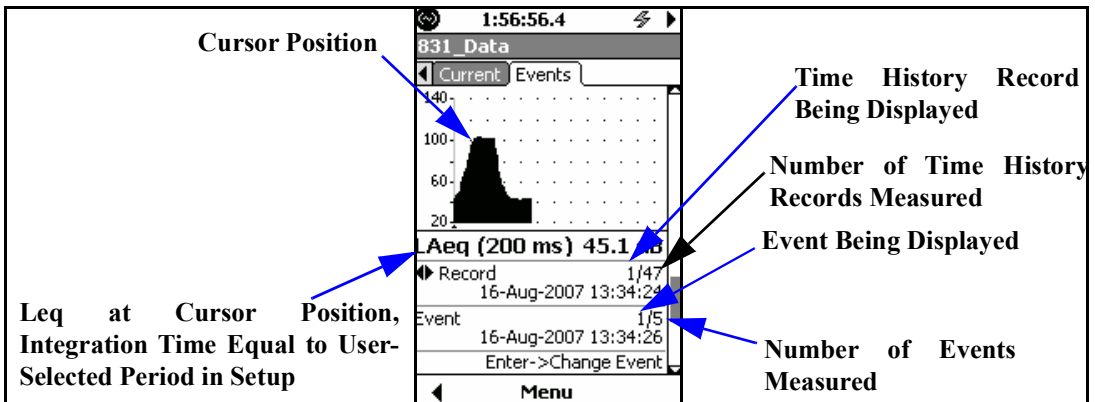

FIGURE 13-17 Event Time History Display, Section 5

Left/Right Arrow Keys

For the display shown in FIGURE 13-17, the $\left\langle \right\rangle$ and $\left\} \right\}$ arrow keys have dual roles as listed below. Use ENTER to toggle between them:

- **Change Record**
- **Change Event**

At any time, the role of the left and right arrow keys is indicated by the left/right arrow icon



and the action of ENTER to change their role is indicated in the lower portions of the display, as shown in FIGURE 13-15.

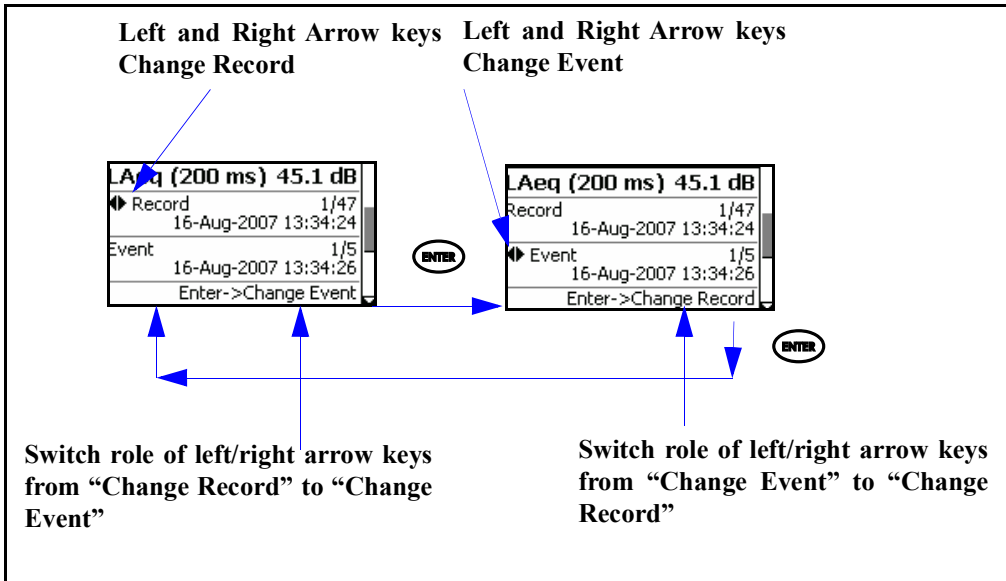

FIGURE 13-18 Role of Left/Right Arrow Keys: Event Time History

Event Spectra Time History Display

With all possibilities included, the sixth display would be a Spectra Time History for the displayed event, as shown in FIGURE 13-19.

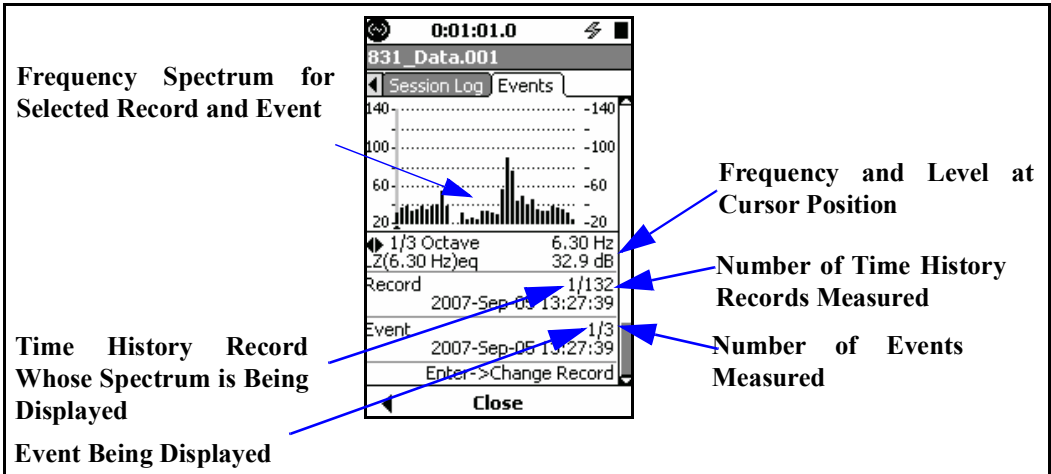





FIGURE 13-19 Event Spectra Time History Display, Section 6

Left/Right Arrow Keys

For the display shown in FIGURE 13-19, the  and  arrow keys have three roles as listed below. Use  to step through them:

- **Change Frequency**
- **Change Record**
- **Change Event**

At any time, the role of the left and right arrow keys is indicated by the left/right arrow icon



and the action of  to change their role is indicated in the lower portions of the display, as shown in FIGURE 13-15.

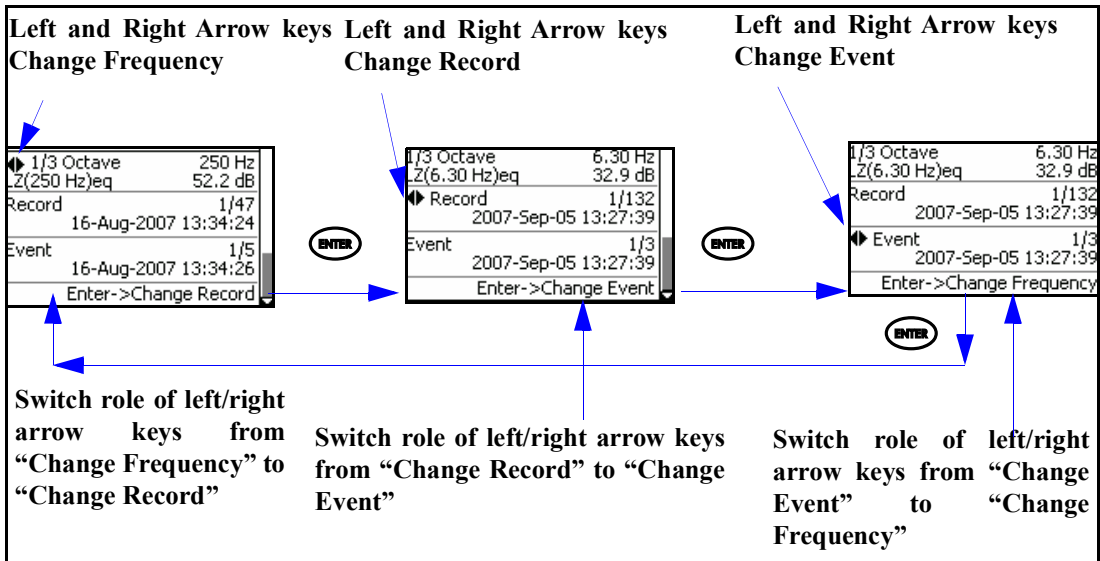

FIGURE 13-20 Role of Left/Right Arrow Keys: Event Spectra Time History

By-Time Event Spectral Time History

With all possibilities included, the seventh display would be a By-Time Event Spectral Time History for the displayed event, as shown in FIGURE 13-19.

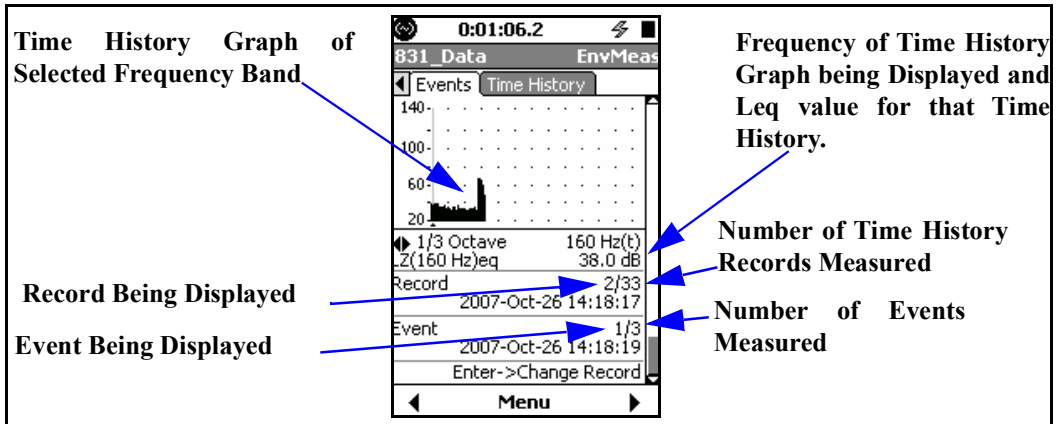

FIGURE 13-21 By-Time Event Spectral Time History Display, Section 7

Left/Right Arrow Keys

For the display shown in FIGURE 13-21, the \leftarrow and \rightarrow arrow keys have three roles as listed below. Use the ENTER key to step through them:

- **Change Frequency**
- **Change Record**
- **Change Event**

At any time, the role of the left and right arrow keys is indicated by the left/right arrow icon



and the action of the ENTER key to change their role is indicated in the lower portions of the display, as shown in FIGURE 13-15.

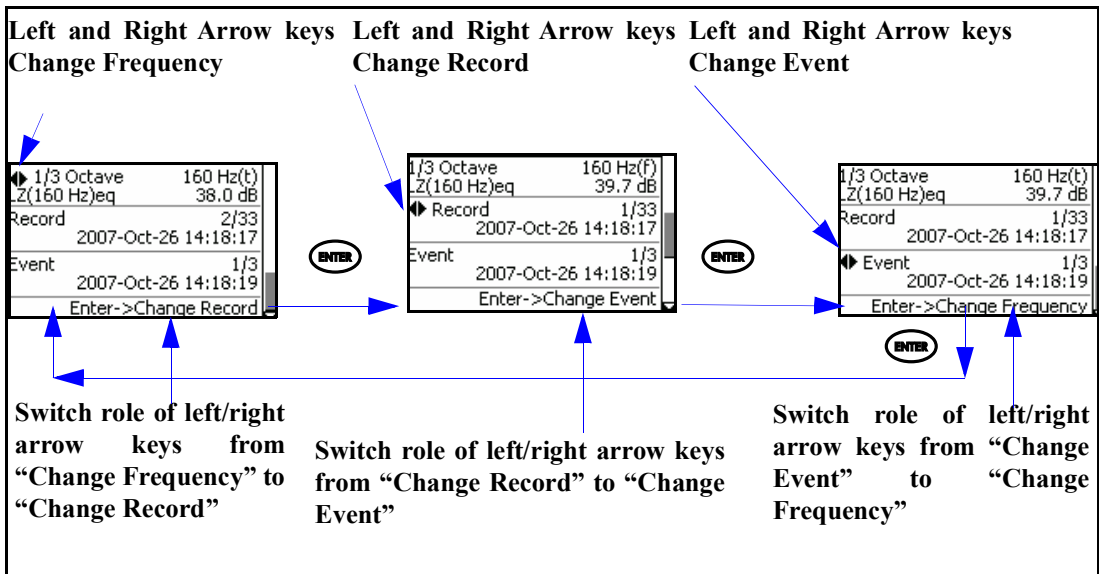

FIGURE 13-22 Role of Left/Right Arrow Keys: By-Time Event Spectral Time History

Link to Time History and Measurement History

When Time History and/or Measurement History have also been enabled, a link is provided to make a rapid transition from any of the Event History displays to the same point in time of the Time History and/or Measurement History display.

Suppose, for example, we are displaying the Time History of the 1 kHz frequency band associated with the 15th record of the 2nd event, as shown in

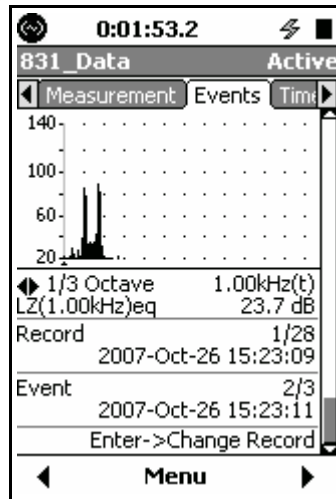

FIGURE 13-23 By-Time Event Spectral Time History

To implement a link, press the **Menu** softkey which will produce the display shown in FIGURE 13-24.

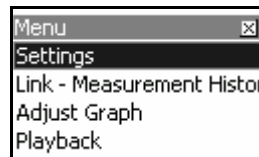

FIGURE 13-24 Link to Time History and Measurement History Displays

Highlight the desired display and press the **ENTER** key to switch to that display, as shown in the following figures.

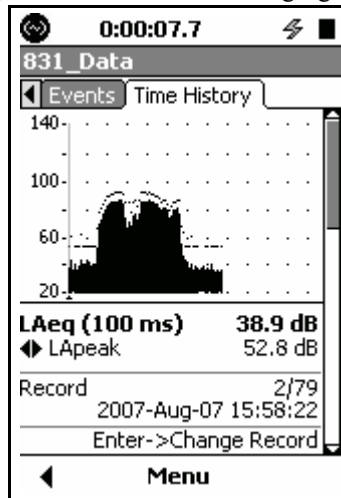

FIGURE 13-25 Time History Display

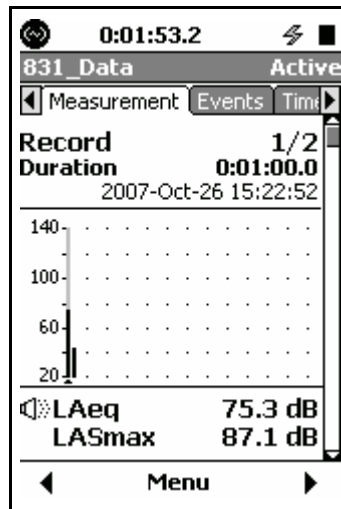



FIGURE 13-26 Measurement History Display

FFT and Tonality

*NOTE: FFT and Tonality functionality is only available on DSP Rev 0.5 or higher. DSP Rev is shown on the **About** display described in Chapter 20.*

The optional FFT mode (831-FFT) is used for signal analysis and tonality measurement using the Fast Fourier Transform (FFT). The FFT provides an amplitude spectrum with linear frequency resolution and is used to determine the frequency content and tonality of sound.

Accessing FFT Mode

To quickly access FFT mode, press the  (TOOLS) key and then navigate up to select the FFT icon.

For tonality assessment, the Model 831 must be in FFT mode and the **ISO 1996-2 Tonality** option must be enabled on the **Tonality** tab under Settings. See "Viewing Tonality Results" in this chapter for more information.

There are two ways to activate the FFT instrument mode on the Model 831. One way is to select the FFT icon on the Control Panel and the other is to recall an FFT setup using Setup Manager as described in Chapter 4.

To access FFT mode, press the  (TOOLS) key to open the Control Panel, select the FFT icon as shown in FIGURE 14-1. Changing modes from the control panel loads the settings that were previously in use for the mode.

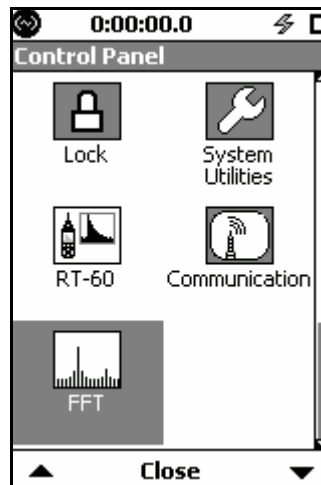

FIGURE 14-1 FFT Icon

Press **ENTER** (ENTER) to open the FFT mode tabs as shown in FIGURE 14-2.

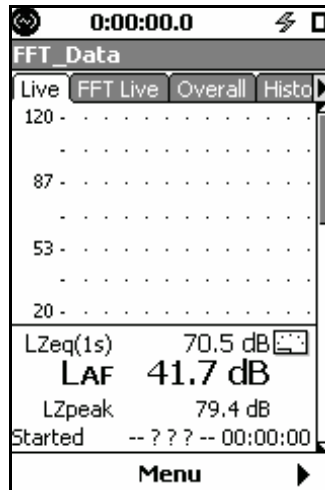

FIGURE 14-2 FFT Pages

The Setup Manager is described in Chapter 4.

In the Setup Manager, the instrument mode associated with each setup file is indicated in the right-hand column as shown in FIGURE 14-3. It is possible to load any setup file without regard to the current instrument mode.

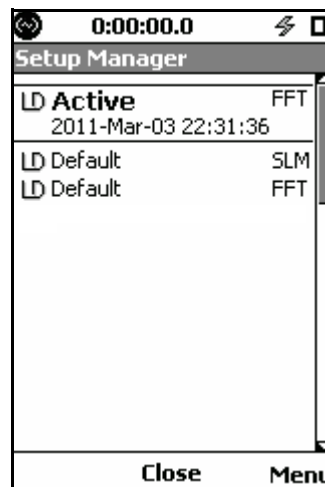

FIGURE 14-3 FFT Setup Manager

Configuring a Measurement

To access the measurement settings, press the Softkey labeled **Menu**, highlight **Settings**, and press **ENTER** to display the settings tabs shown in the following section. The active parameter values shown in this section represent the default values.

General Tab

The **General** setting tab, shown in FIGURE 14-4, provides a default filename and measurement description text field to annotate the measurement. These are similar to those of other instrument modes. Use the Setup Manager and these fields to organize and document your measurement projects.

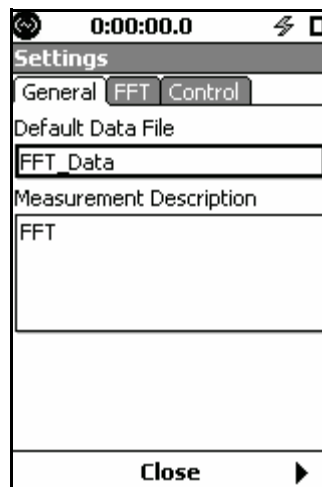

FIGURE 14-4 General Tab

Default Data File

The **Default Data File** text field is used to customize the file name for FFT data files. This file name can be used to indicate the type of data that was taken or the project the data is from. This name can be up to 8 characters long and contain letters, numbers, and certain symbols.

Measurement Description

The **Measurement Description** is used to annotate a measurement and can be up to 63 characters in length.

FFT Tab

The **FFT** tab is used to specify settings for FFT measurements, as shown in Figure 14-5.

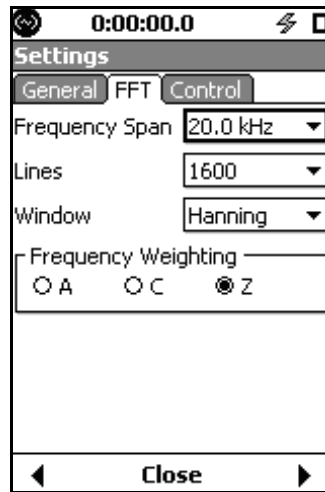

FIGURE 14-5 FFT Tab

Frequency Span

Use the **Frequency Span** setting to specify the upper end of frequency response. The choices are:

- 20 kHz
- 10 kHz
- 5 kHz
- 2 kHz
- 1 kHz
- 500 Hz
- 200 Hz
- 100 Hz

Lines

The **Lines** setting selects the number of discrete frequency bands or bins.

The choices are:

- 6400
- 3200
- 1600
- 800
- 400

The frequency resolution is rounded to at most 2 decimal places on the Model 831.

The frequency resolution and bandwidth of each bin is determined by the Frequency Span and the number of lines as shown in Table 14-1.

		Frequency Span (Hz)							
		100	200	500	1000	2000	5000	10000	20000
Number of Lines	400	0.25	0.5	1.25	2.5	5	12.5	25	50
	800	0.125	0.25	0.625	1.25	2.5	6.25	12.5	25
	1600	0.0625	0.125	0.3125	0.625	1.25	3.125	6.25	12.5
	3200	0.03125	0.0625	0.15625	0.3125	0.625	1.5625	3.125	6.25
	6400	0.015625	0.03125	0.078125	0.15625	0.3125	0.78125	1.5625	3.125

Table 14-1 Frequency Resolution (Hz)

Window

Three **Window** options are available in the Model 831 to provide emphasis or balance between frequency selectivity and amplitude ripple as the signal frequency varies from one bin to another. The choices are:

- Rectangular
- Hanning
- Flat Top

Frequency Weighting

The **Frequency Weighting** setting selects a broadband A, C or Z-weighted pre-filter. A broadband Leq and peak level is measured using this weighting in addition to the weighting being applied to the FFT spectrum.

Control Tab

FIGURE 14-6 shows the options for the **Control** tab.

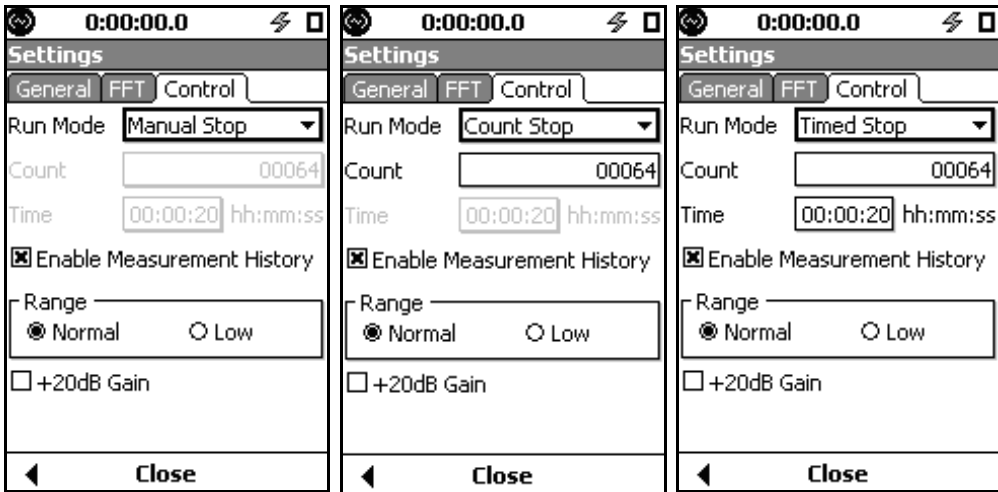

FIGURE 14-6 Control Tab Options

Run Mode

The **Run Mode** setting controls how a measurement is terminated and how history records are accumulated. The three run modes are described in Table 14-2 below.







Manual Stop	A Manual Stop measurement begins with a press of the  (RUN/PAUSE) key and ends with a press of the  (STOP/STORE) key. If measurement history is enabled, a history record will be created with each stop. As many runs as desired can be made and the overall data includes all samples from each FFT record.
Count Stop	A Count Stop measurement begins with a press of the  key and ends when the number of discrete FFT records equals the Count setting value. If measurement history is enabled, a history record is created. A measurement may be terminated early by pressing  .
Timed Stop	A Timed Stop measurement begins with a press of the  key and ends when the run time for this measurement equals the Time setting value. If measurement history is enabled, a history record will be created when the number of FFT records equals the Count setting value. A measurement may be terminated early by pressing  .

Table 14-2 FFT Run Modes

Time

The **Time** setting is used to determine the run time for the Timed Stop mode as described in Table 14-2.

A history record is an average of FFT records. The number of FFT records in each history record is controlled by the Count and/or Run Mode as described in Table 14-2.

Enable Measurement History

The **Enable Measurement History** setting enables the storing of history records. The measurement history is helpful as an automatic notebook to save each manual measurement for tonal or THD analysis, or it can store a time history for a waterfall graph or to illustrate a machine run-up or run-down cycle to evaluate modes.

Range

The **Range** setting, in conjunction with the **Gain** setting, determines the amplitude measurement range of the FFT as illustrated in the Table 14-3.

+20 dB Gain

The +20 dB **Gain** setting, in conjunction with the **Range** setting, determines the amplitude measurement range of the FFT as illustrated in Table 14-3.

The maximum input levels shown are for a typical microphone sensitivity of 50mV/Pa

	+20 dB Gain Off	+20 dB Gain On
Normal	143 dB peak maximum	123 dB peak maximum
Low	110 dB peak maximum	90 dB peak maximum

Table 14-3 Maximum Input for Range and Gain

Count

The **Count** setting is used with the Count Stop and the Timed Stop modes to generate a *count average* measurement as described in Table 14-2.

The minimum required count value is determined by the Frequency Span settings as illustrated in Table 14-4. The minimum count prevents data being gathered faster than it can be stored into flash memory.

Frequency Span	Minimum Count
20 kHz	20
10 kHz	10
5 kHz	5
2 kHz	2
1 kHz	1
500 Hz	1
200 Hz	1
100 Hz	1

Table 14-4 Minimum Count

$$\text{Resolution} = \text{Span} / \text{Lines}$$

$$\text{FFT Time} = 1 / \text{Resolution}$$

Narrow frequency resolutions take longer to gather, so the response is slower. For example, when configured for 100 Hz span and 6400 lines, each FFT record is 64 seconds long. Using 67% overlap allows the subsequent frequency spectrum updates to occur at approximately 1/3 the time of the initial update. These nominal times are given in Table 14-5.

		Frequency Span (Hz)							
		100	200	500	1000	2000	5000	10000	20000
Lines	400	1.32	0.66	0.264	0.132	0.066	0.0264	0.0132	0.0066
	800	2.64	1.32	0.528	0.264	0.132	0.0528	0.0264	0.0132
	1600	5.28	2.64	1.06	0.528	0.264	0.1056	0.0528	0.0264
	3200	10.56	5.28	2.11	1.06	0.528	0.2112	0.1056	0.0528
	6400	21.12	10.56	4.22	2.11	1.06	0.4224	0.2112	0.1056

Table 14-5 Nominal Calculation Time (seconds) with 67% Overlap

The actual amount of overlap can vary based on processor load. Varying the amount of overlap allows the Model-831 to process all incoming sound samples even when the processor is busy (i.e., storing a file). Variations in the

amount of overlap also appear as variations in the duration of individual FFT records for a given history record.

For example, if you generate or export FFT data files from SLM Utility-G3 or G4, you may see that start times of some measurements begin before previous measurement durations are completed. This disparity reflects the overlapping method used by the meter for capturing and processing all sound samples.

Tonality Tab

The **Tonality** tab, as shown in Figure 14-7, provides settings for ISO 1996-2 Annex C Tonality Assessment.

When enabling the Tonality feature, the Model 831 presents a prompt if any settings are not in agreement with the ISO 1996-2 Standard. The prompt also includes the option to automatically change settings to values in accordance with the standard.

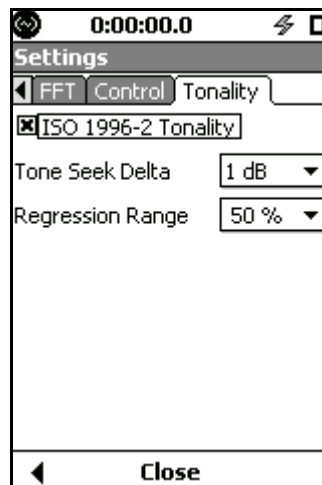

FIGURE 14-7 Tonality Tab

ISO 1996-2 Tonality

To measure and assess tonality in accordance with the ISO 1996-2 standard, the measurement must be A-weighted, averaged for at least one minute, and use a Hanning window type.

The **ISO 1996-2 Tonality** setting enables tonality measurements while in FFT mode.

Press **(ENTER)** to enable tonality assessment.

Tone Seek Delta

Specify the **Tone Seek Delta** to determine noise pauses in your measurement, as described in ISO 1996-2 C.4.2. The default is 1 dB.

For normal and smooth spectra, consider specifying a tone seek delta of 1 dB. For irregular spectra, or spectra with short averaging times (as mentioned in C.2.2), specifying values of 3 dB or 4 dB may provide better results.

If Tonality is enabled but Measurement History disabled, calculations are made using Overall data.

For more information on selecting a regression range, see ISO 1996-2 section C.4.

Regression Range

Specify the **Regression Range** to determine masking noise, as described in ISO 1996-2 C.4.4.

The percentage selected reflects the + and - range of the critical bandwidth to the right and left of the center frequency. For example, selecting **75%** results in a range that is 75% to both the left and right of the central frequency.

Viewing and Analyzing Results

The Model 831 can measure FFT spectra with up to 6400 lines of resolution. Because of the limited resolution of the display, every line displayed on the graph may contain more than one measured value. The amplitude and frequency displayed for the cursor position is determined by the maximum value of the underlying FFT lines.

Figure 14-8 shows data on the **FFT Live** tab.

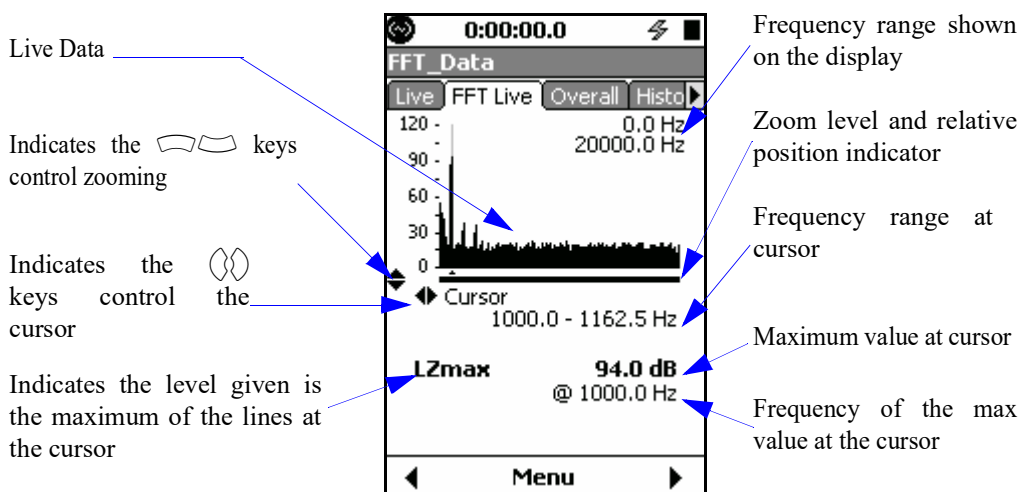

FIGURE 14-8 FFT Live

Figure 14-9 shows FFT data on the **Overall** tab.

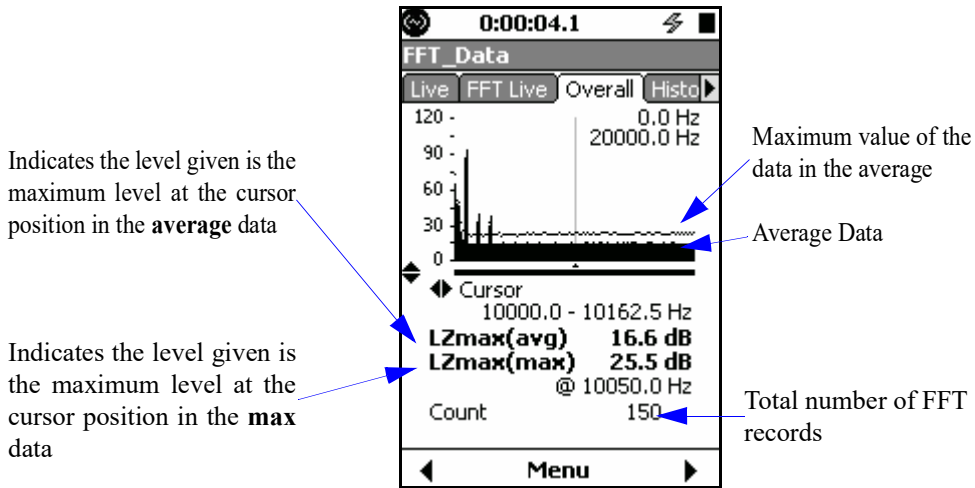

FIGURE 14-9 FFT Overall

Figure 14-10 shows FFT History data on the **History** tab.

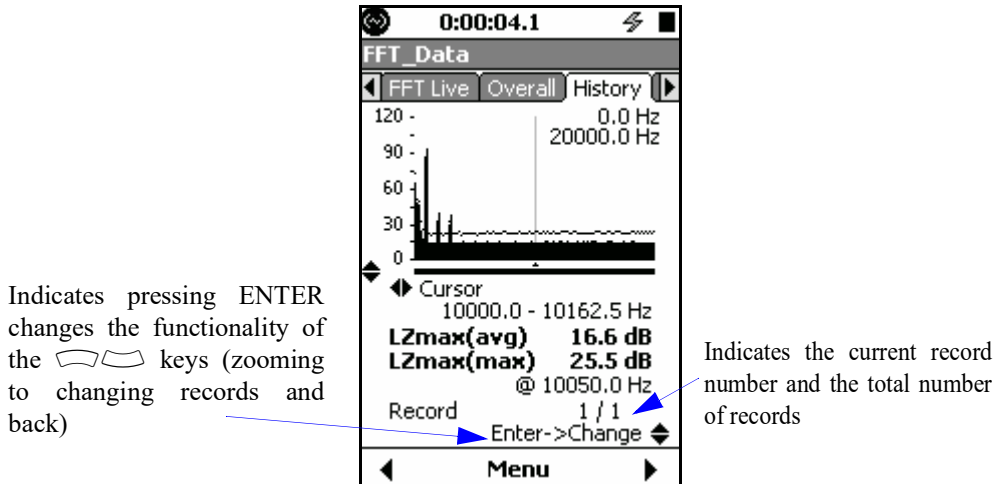



FIGURE 14-10 FFT History

Zooming In/out

The Model 831 provides a graphical zoom function that displays a narrower frequency range and the spectrum on the graph is displayed at a higher frequency resolution. This is useful if you want to take a closer look at an area of interest.

The Model 831 allows zooming from the configured number of lines up to a one-to-one correspondence between displayed lines and FFT lines. When zoomed in one-to-one, the level indicator changes to indicate that the displayed level is no longer the max of lines, but rather the value of the line at the cursor (see FIGURE 14-11).

To zoom in, press the  key and press the  key to zoom out. Notice that the bar underneath the graph indicates the zoom level and relative position of the displayed data within the overall dataset. Additionally, the frequency range currently displayed on the graph is shown in the top-right corner.

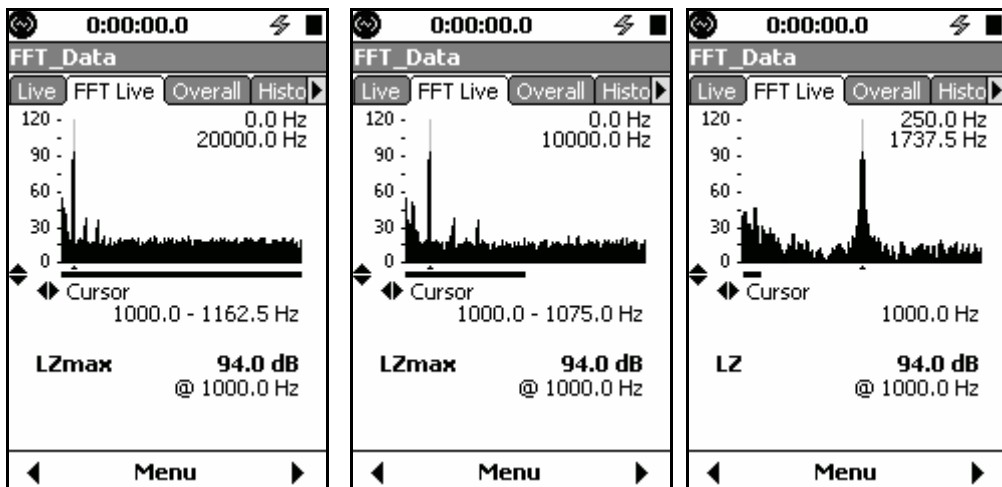

FIGURE 14-11 FFT Live Tab

Changing the Cursor Type

The Model 831 provides both manual cursor control and a max-tracking cursor, both of which can be displayed with or without harmonic cursors. To change the cursor type press the **Menu** soft-key, highlight **Cursor Type** as shown in FIGURE 14-12 and press **ENTER**.

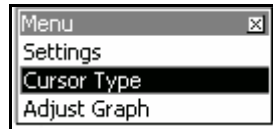

FIGURE 14-12 Cursor Menu

The cursor control dialog shown in FIGURE 14-13 will appear at the bottom of the display.

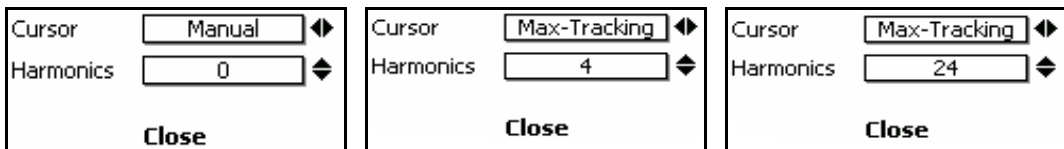

FIGURE 14-13 Cursors Type



Cursor Type

Select either **Manual** or **Max-Tracking** cursor with the **↩** and **↪** keys.

With the cursor type set to **Manual** the frequency cursor is controlled manually using the **↩** and **↪** keys.

With the cursor type set to **Max-Tracking** the cursor will be set automatically to the frequency band that has the highest amplitude.

Harmonic Cursors

The number of harmonic cursors can be set from zero to twenty-four in increments of four using the  and  keys. Depending on the frequency of the primary cursor, all of the harmonic cursors may not be shown. For example, with a frequency span of 20 kHz and a fundamental frequency of 5 kHz only three harmonic cursors are within the frequency range and shown. FIGURE 14-14 illustrates this example.

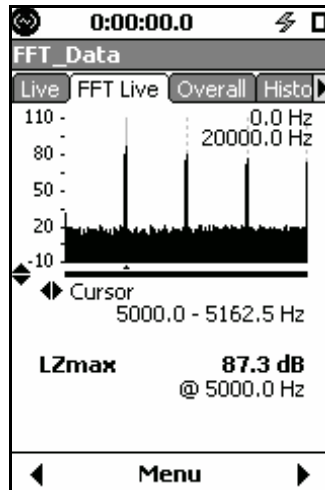

FIGURE 14-14 Harmonic Cursors

Max-Tracking Cursor

With the cursor type set to Max-Tracking, the cursor will be set automatically to the frequency band that has the highest amplitude. When zoomed in, if the maximum is not in the display window, the window moves to center over the max. The max-tracking state and the relative position of the display window are indicated on the display as shown in FIGURE 14-15.

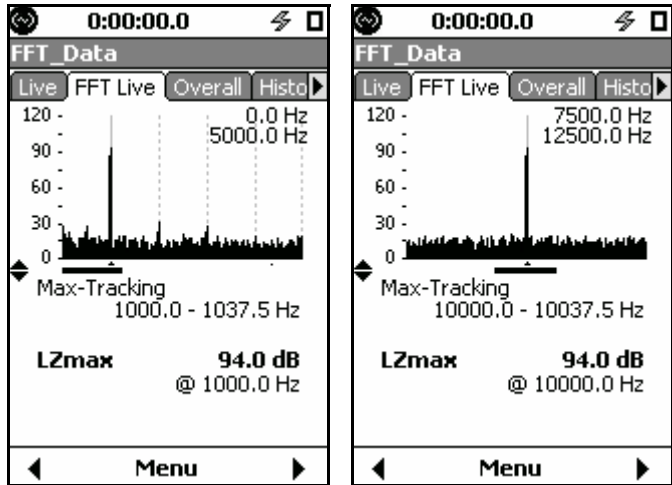

FIGURE 14-15 Max-Tracking Cursors

Additional Information

When the cursor is on a line less than 3 Hz, (-3 dB), the displayed values are gray as shown in FIGURE 14-16.

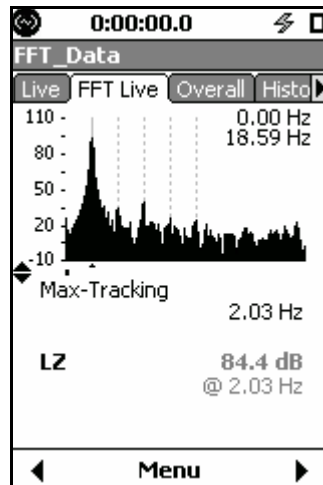

FIGURE 14-16 Below 3Hz

The scaling of the y-axis can be adjusted as described in the Adjust Graph Scale section of Chapter 5.

The FFT graphs on the **FFT Live**, **Overall**, and **History** tabs can be adjusted independently of the sound pressure level graph on the **Live** tab as shown in FIGURE 14-6.

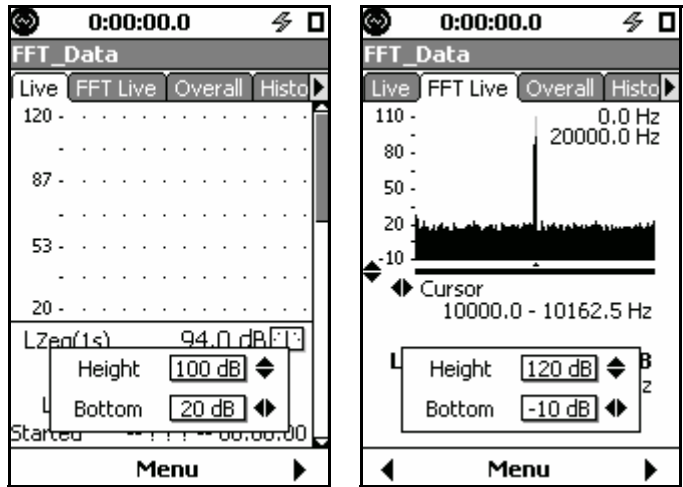

FIGURE 14-17 Dual Range Displays

Viewing Tonality Results

To view tonality data, navigate to the **Tonality** tab in FFT mode. The **Tonality** tab is shown in Figure 14-18.

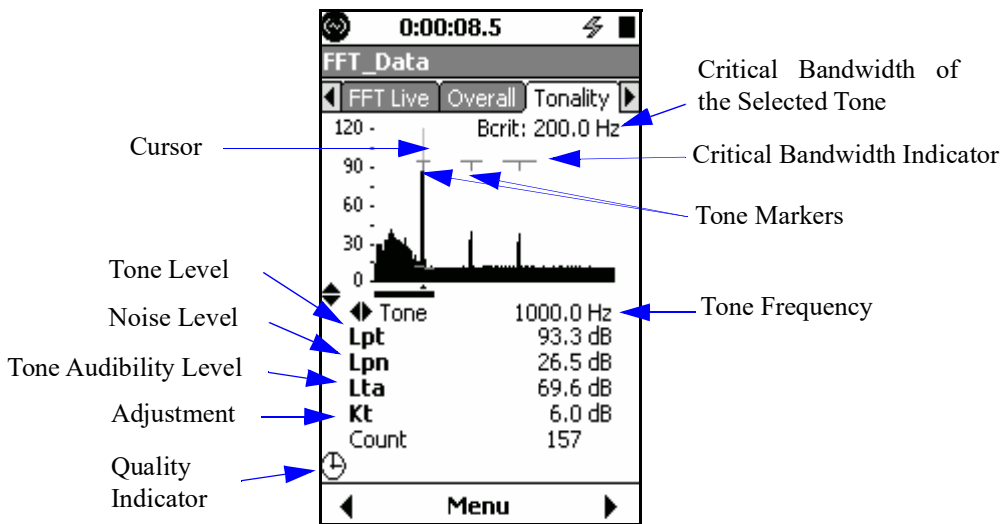

FIGURE 14-18 Tonality Data

For more information on **Lpt**, **Lpn**, **Lta**, **Kt**, and **Critical Bandwidth**, see the ISO 1996-2 Standard, Annex C.

You cannot navigate through tones while simultaneously performing a measurement.

With Measurement History enabled, you can navigate through Tonality measurement records, just as you can with other FFT measurements.

The Tonality graph displays critical bandwidth, tone indicators, and noise regression.

To view Tonality results, you can navigate the same as you would on other tabs in FFT mode. You can also view specific data for each tone by navigating from tone to tone on the graph by using the \leftarrow and \rightarrow keys. If a measurement is complete, the cursor starts on the first valid tone (or the tone corresponding to the lowest frequency). If no valid tones exist in the measurement, you can also navigate to the unqualified tones that do not meet bandwidth regression criteria. You can also zoom in and out of the Tonality graph the same as you would on other FFT graphs.

Additionally, you can specify the cursor type appearing on the Tonality graph to be **Manual** or **Max-Tracking** in the same way as other FFT results. You can also specify the number of harmonic cursors appearing on the Tonality

graph, similar to other FFT results. For more information, see the "Changing the Cursor Type" section in this chapter.

Tonality Measurement Deficiencies

When the % indicator is displayed, the graph will show narrow bands of noise that do not meet the bandwidth requirements in the Tonality Standard. You can navigate and view information on these bands the same as if they were valid tones according to the Tonality Standard.

The **Tonality** tab displays quality indicators when deficiencies, in relation to the ISO 1996-2 Standard, are detected in measurements.

Figure 14-19 shows an example of the **Tonality** tab with quality indicators appearing.

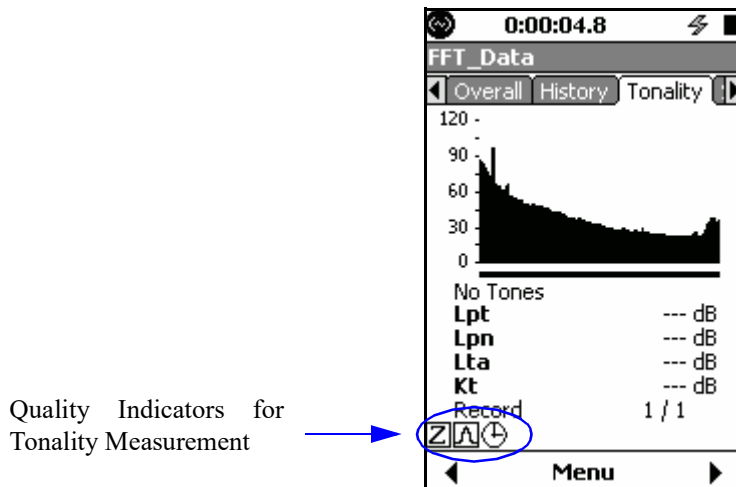

FIGURE 14-19 Quality Indicators on Tonality Tab

Table 14-6 describes each quality indicator, the corresponding deficiency for each indicator, and the remedy for each deficiency.









Quality Indicator Icon	Deficiency	Remedy
	The measurement has not been averaged for at least one minute (see ISO 1996-2 section C.2.2)	Run the measurement for at least one minute.
	The weighting is set to C (see ISO 1996-2 section C.2.2).	Change the setting to A weighting to perform a standard measurement.
	The weighting is set to Z (see ISO 1996-2 section C.2.2).	Change the setting to A weighting to perform a standard measurement.
	The window type is not Hanning (see ISO 1996-2 Note 1).	Change the setting to Hanning window to perform a standard measurement.
	The tone bandwidth is not less than 10% of the critical bandwidth (see ISO 1996-2 section C.2.2).	Increase the resolution of the measurement by increasing the number of Lines , or by decreasing the Frequency Span in the FFT settings. The appearance of the icon even after the Hanning window is selected indicates that the bands of noise do not qualify as tones as specified in the ISO 1996-2 standard.
	The effective bandwidth is not less than 5% of the critical bandwidth.	Change the window type.
	The sound measurement does not contain sufficient regression data and therefore cannot display a standard linear regression line.	Increase the Regression Range on the Tonality tab.

Table 14-6 Quality Indicators for Tonality Deficiencies

Storing Data

Tonality data can be stored in the same method as described for other FFT data in this section.

Press the  key to store data. As shown in FIGURE 14-20, the suggested filename is what was configured on the **General** settings tab.

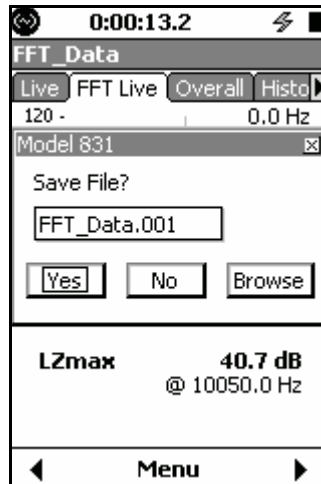





FIGURE 14-20 Saving Files

Viewing Stored Data

Data Explorer only shows files for the current instrument mode.

Use the Data Explorer utility to view stored measurements on the Model 831. Data Explorer is opened by pressing the  key and then selecting the icon labeled **Data Explorer**. When this utility opens, it displays saved files. To open a file, select it and press . The data can now be viewed as outlined in the "Viewing and Analyzing Results" section with the exception that the **Cursor Type** and **Adjust Graph** controls are not available. These settings follow the configuration used when viewing live data.

Return to Sound Level Meter Mode

When the FFT mode is active, the SLM icon is available in the Control Panel as shown in FIGURE 14-21. To return to the Sound Level Meter mode, press the  key to open the Control Panel, select the SLM icon and press .

Changing modes using the icon on the control panel loads the setup that was previously in use for that mode.



FIGURE 14-21 SLM Icon

This chapter describes the measurement features associated with the RT-60 optional firmware 831-RT.

Accessing RT-60 Mode

There are two ways to activate RT-60 measurement mode. One way is to select the RT-60 icon on the Control Panel and the other is to recall an RT-60 setup using Setup Manager.

Using the RT-60 Icon

A shortcut is to press the  (TOOLS) key and then the Up Arrow key twice to highlight the RT-60 icon.

The RT-60 icon is replaced by the Room Acoustics icon if the 831-RA option is installed.

To access the RT-60 mode, press the  (TOOLS) key to open the Control Panel, select the RT-60 icon as shown in FIGURE 15-1.

Changing modes using the icon on the control panel loads the setup that was previously in use for that mode.

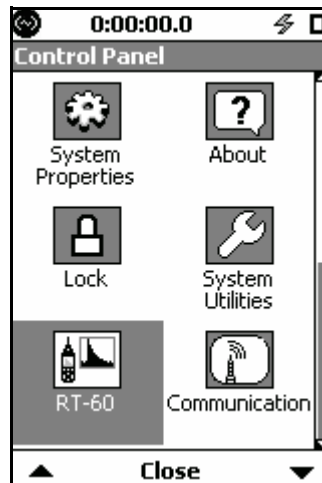



FIGURE 15-1 RT-60 Icon

Press the  (ENTER) key to open the RT-60 mode tabs as shown in FIGURE 15-2.

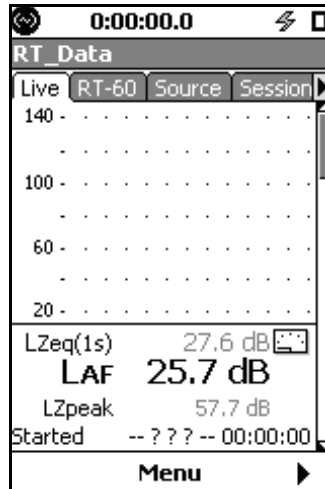

FIGURE 15-2 RT-60 Tabs

Using the Setup Manager

To load a setup file via the Setup Manager, press the  key to open the Control Panel. Select the Setup Manager icon as shown in FIGURE 15-3.



FIGURE 15-3 Setup Manager Icon

Open the Setup Manager to display the available setups as shown in FIGURE 15-4. Note that the instrument mode associated with each setup file is indicated in the right-hand column. RA indicates RT-60 (Room Acoustics) mode.

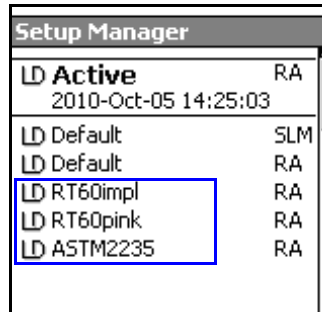

Setup Manager	
LD Active	RA
2010-Oct-05 14:25:03	
LD Default	SLM
LD Default	RA
LD RT60impl	RA
LD RT60pink	RA
LD ASTM2235	RA

FIGURE 15-4 RT60 Setups in Setup Manager

If you have created and saved your own RT-60 setups, these will also appear in the list and can be similarly selected.

As a “quick start”, several predefined RT-60 setups are provided (see the “Making a Measurement” on page 15-3’):

- **RT60impl** - Impulse method
- **RT60pink** - Interrupted Noise method using pink noise via the internal noise source
- **ASTM2235** - Specific to ASTM E2235 using the internal noise source

Any setting changes made while one of these setups is active will become permanent. Refer to the Setup Manager section in Chapter 4 for information on creating custom setup files.

Making a Measurement

Selecting the Method

There are two methods available for measuring reverberation time:

- Impulse Method (using Schroeder reverse integration)
- Interrupted Noise Method

In many instances, RT60 measurements can be made using the predefined setup files provided.

Impulse Method

Step 1 Recall RT60impl from the Setup Manager.

Step 2 Make a measurement using a starter pistol or balloon burst (operator is in room).

Step 3 Move microphone or source position and repeat as desired.

Interrupted Noise Method

Step 1 Recall RT60pink from the Setup Manager.

Step 2 If using the internal noise generator, connect the AC output of the Model 831 to an amplifier/speaker system. If using an external generator, set the RT-60 noise type to “OFF” (see the “Customizing Measurements” on page 15-20’) and generate noise externally.

Step 3 Make a measurement (operator exits room until the desired number of decays is obtained). A trial measurement may be needed to ensure the noise source is sufficiently loud and the trigger level is exceeded.

Step 4 Move microphone or source position and repeat the number of times needed for desired accuracy grade (see “Accuracy Grade” on page 15-28).

Measurement State Sequence

This section presents the sequence of Model 831 screen displays and actions taking place during an a measurement.

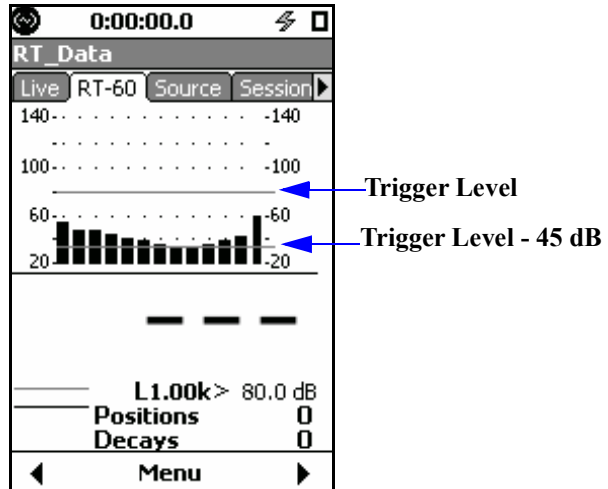

FIGURE 15-5 RT-60 Status Screen

Initiate Measurement

Initiate a measurement by pressing the  (RUN/PAUSE) key, at which time the icon shown in FIGURE 15-6 will appear in the lower left corner of the screen. This lasts as long as the configured Exit Time. No data is taken while this icon is shown.



FIGURE 15-6 Exit Prompt

Background Noise Measurement

After the Exit Time has passed, the background noise is measured, as indicated by the icon shown in FIGURE 15-7. The background noise level is measured for 5 seconds and is then used for determining signal-to-noise ratio on successive decays. The background noise level is measured for every position, i.e., every time “Run” is pressed.

T20 uses data from -5 dB to -25 dB and requires a signal to noise ratio of at least 35 dB. T30 uses data from -5 dB to -35 dB and requires a signal to noise ratio of at least 45 dB.



FIGURE 15-7 Background Measurement Display

Filling Pre-trigger Buffer

When the background measurement has completed, the pre-trigger buffer fills as indicated by the icon shown in FIGURE 15-8.

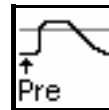

FIGURE 15-8 Pre-Trigger Buffer Display

Ready For Excitation Signal



When the pre-trigger buffer is full, the “Ready” icon shown in FIGURE 15-9 will appear in the lower left corner of the screen, and the  (STOP/STORE) key will flash red to indicate that the source within the room should be activated. If using the internal noise source, it will start automatically.



FIGURE 15-9 Ready Display

Valid (Interrupted Method Only)

The Valid display will not appear when using the Impulse Method.

When using the Interrupted Noise method, the “Valid” icon shown in FIGURE 15-10 indicates that the room has been successfully energized. This occurs when the trigger level is exceeded for at least as long as the configured Build Time. If using an external noise source, do not stop the noise output until this icon is displayed. The  key will stop flashing to indicate that an external noise source should be turned off. If using the internal noise source, it will stop automatically.

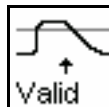

FIGURE 15-10 Valid Display

Triggered

When the measurement has been triggered, the “Triggered” icon shown in FIGURE 15-11 will appear in the lower left corner of the screen.

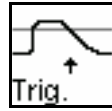

FIGURE 15-11 Triggered Display

Measurement Complete

When the measurement has completed, the display shown in FIGURE 15-12 will appear. The icon in the lower left of the screen indicates a successful measurement, and the position count has been incremented. The spectrum graph displayed is for the last excitation.

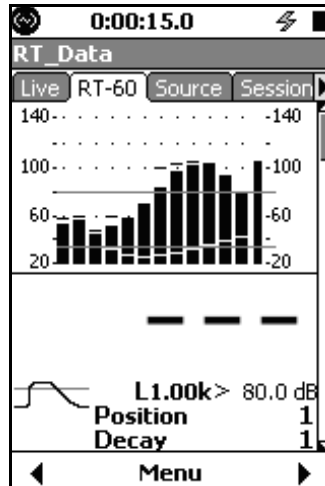



FIGURE 15-12 Measurement Completed

Repeat Measurement

The operator can now move the microphone and/or noise source and press the  key to initiate another measurement sequence.

Viewing and Analyzing Results

The data displays are the same regardless of the method used for the measurement.

Following a measurement, the data can be viewed on the **RT-60** tab as follows:

- RT-60 Status
- RT-60 Spectra
- RT-60 Decay Curve
- Excitation Levels
- Quality Summary (two pages for 1/3 octave data)
- Quality Detail
- Accuracy Grade

RT-60 Status

The RT-60 Status display shows the previously described measurement states. After the measurement is complete, it also shows the L_{max} , L_{eq} , and background level for each frequency, as well as the Z-weighted L_{eq} value.

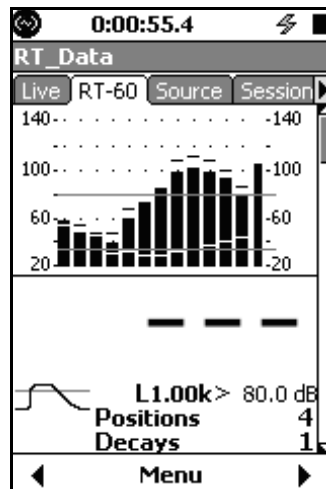

FIGURE 15-13 RT-60 Status

RT-60 Spectra

The RT-60 Spectra display shows a graph of the reverberation times for each frequency of the ensemble average or an individual decay. Both T30 (black line) and T20 (gray line) data are displayed.

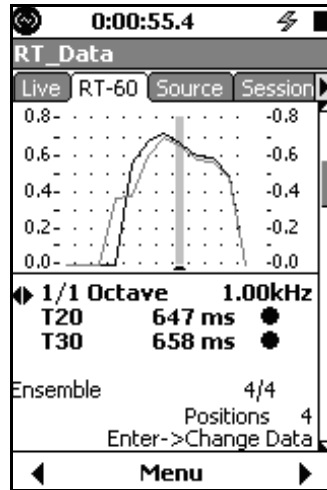

FIGURE 15-14 RT-60 Spectra

*The navigation described here applies to most of the pages on the **RT-60** tab.*

*A prompt near the bottom of the display (**Enter -> Change data** in Figure 15-14) indicated where the focus of the left/right arrows will go when **ENTER** is pressed.*

When viewing information for the ensemble average, pressing **ENTER** toggles the role of the left/right arrow keys between changing ensemble/decay and changing frequency.

When viewing information for an individual decay, pressing **ENTER** toggles the role of the left/right arrow keys between changing ensemble/decay, frequency, and decay number. See FIGURE 15-5.

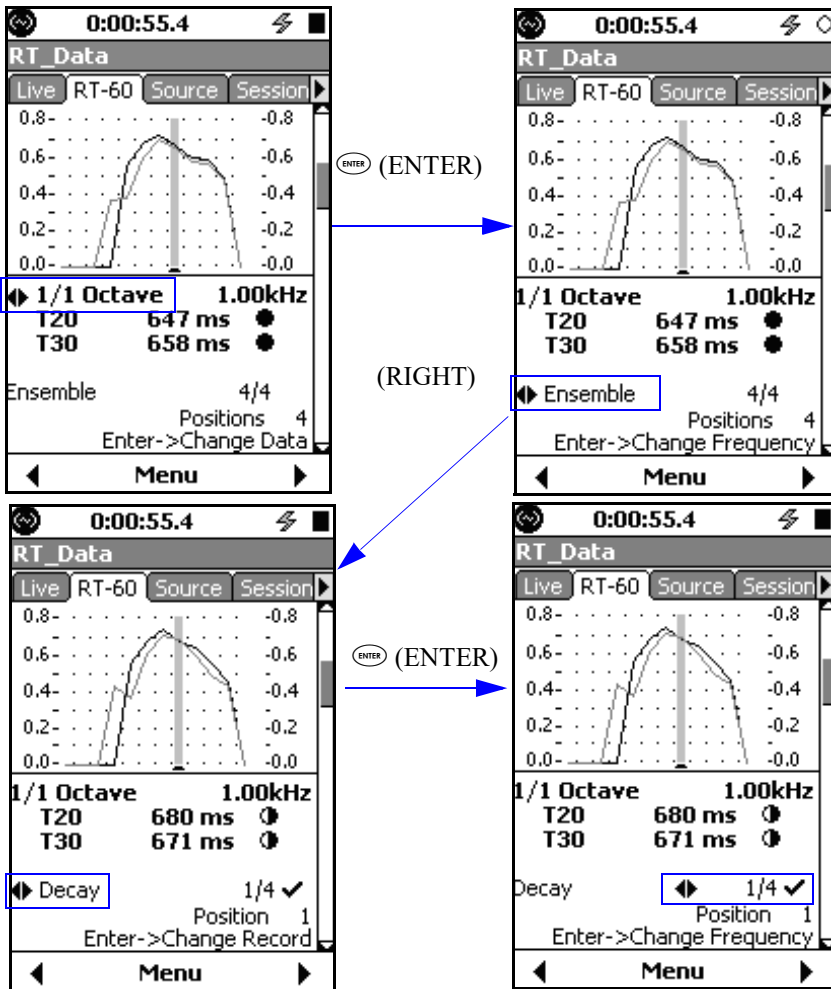

FIGURE 15-15 Navigation

RT-60 Decay Curve

In the upper right corner of the display is a $t=1.98s$. This value represents the time duration of the data being displayed

The RT-60 Decay Curve display shows the time domain ensemble or individual decay curve.

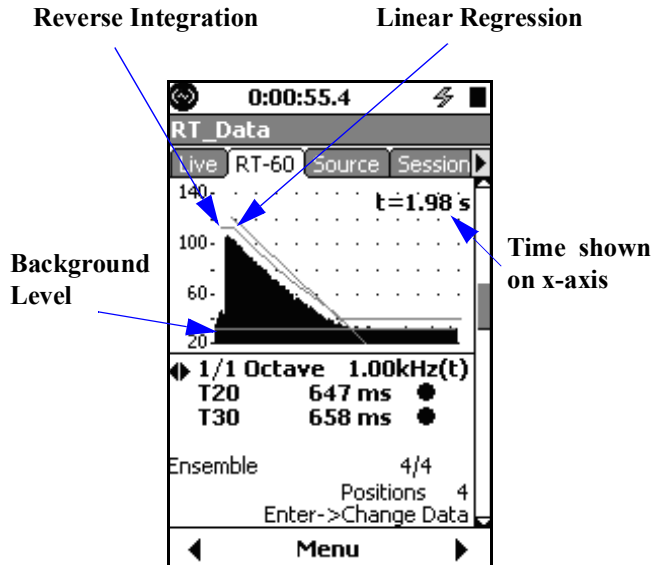

FIGURE 15-16 RT-60 Decay Curve

The linear regression line on the graph is usually associated with the T30. However, if the T30 decay time was undetermined, the T20 data is used. When the Impulse method is used, the reverse integration curve is also shown on the graph.

Excitation Levels

The Excitation Levels display shows the equivalent, maximum, and background levels for all frequency bands of the ensemble average or for an individual decay. From this it can be determined which frequencies were sufficiently energized for a desired decay range.

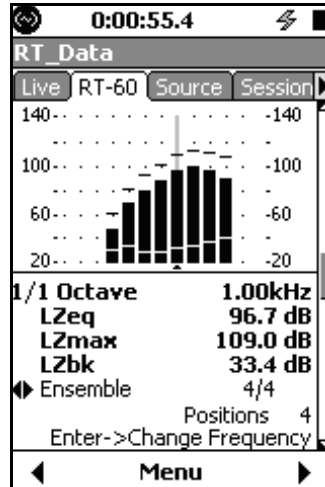

FIGURE 15-17 Excitation Levels

LZeq is computed as the Leq between the initial exceedance of the trigger level to when the signal falls below the trigger level minus 5 dB.

LZmax is the maximum value of the time history.

LZbk is the background level measured for this frequency at this position.

Quality Summary

The left/right arrows keys will toggle between T20 and T30.

This display provides a summary of the quality indicators for all frequencies between the configured highest and lowest filters. For 1/3 octave measurements, this display may span two pages. For more information about the quality indicators, see the “Quality Indicators” on page 15-27.

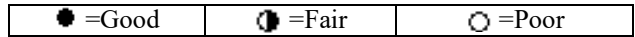

If a decay time could not be determined, the quality indicator icon will not be present.

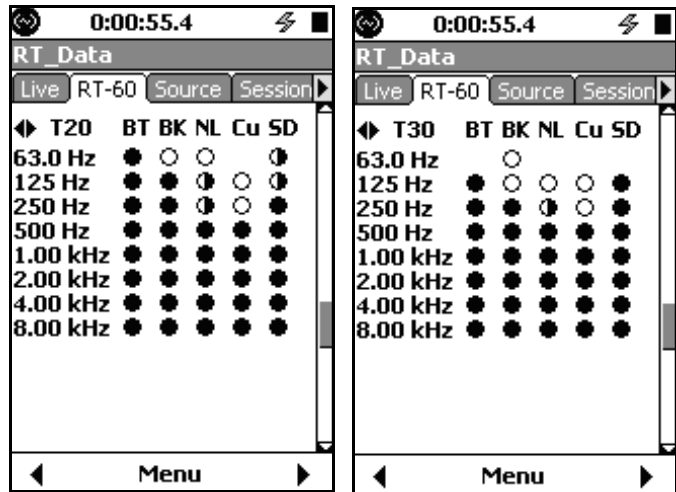

FIGURE 15-18 Quality Summary

Quality Detail

The left/right arrow keys will scroll through the frequencies.

This display provides details about the quality indicators for the selected frequency. If a metric is determined to be “Fair” or “Poor”, the criteria that failed is shown in the right-hand column as shown in FIGURE 15-19.

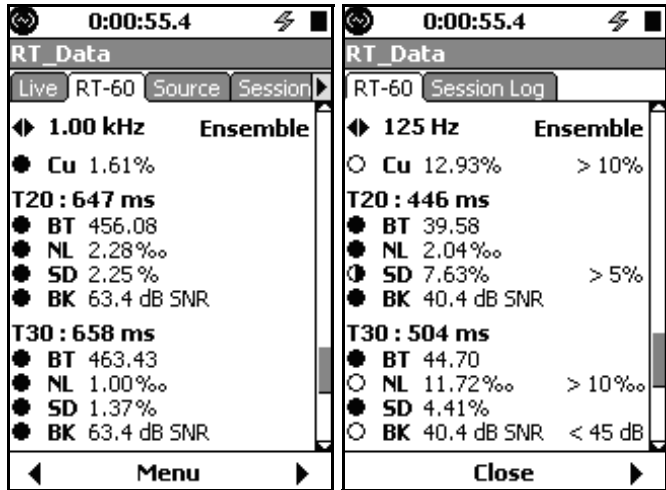

FIGURE 15-19 Quality Detail

Accuracy Grade

For more information on accuracy grade, including Estimated Grade, Frequency Range, Positions, and Decays, see ISO 3382-2:2008 (E) and the G4 LD Utility manual.

The Accuracy Grade page shows values according to the criteria described in ISO 3382-2:2008 (E).

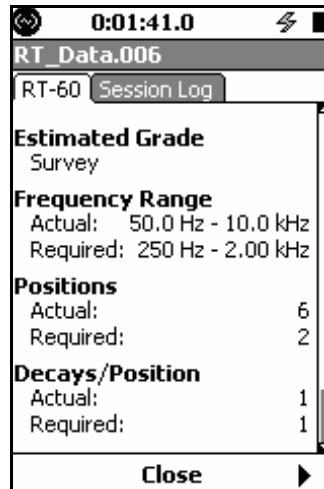

FIGURE 15-20 Accuracy Grade Page

Excluding Samples from the Ensemble

Excluding a decay will exclude all frequencies for the selected decay.

Once the data has been stored, it cannot be edited in the Model 831; therefore individual decays cannot be included or excluded from the ensemble.

When the display is showing data for an individual decay, the operator has the option of excluding the current decay from the ensemble average. Excluding decays from the ensemble is useful when one or more are corrupt, as is evident in FIGURE 15-21. In this case, the operator coughed during a measurement.

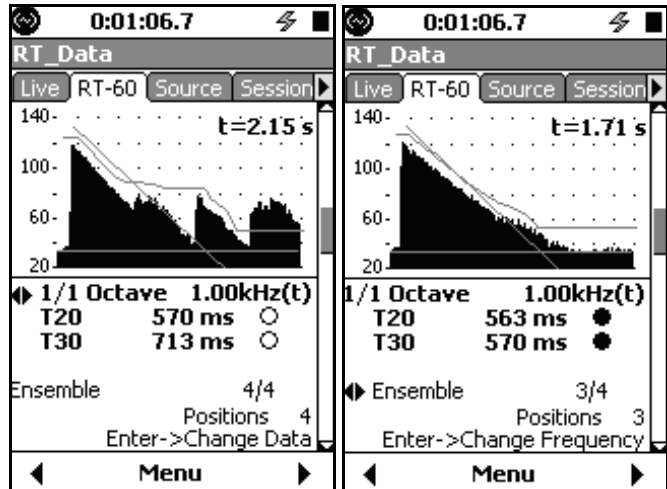

FIGURE 15-21 Ensemble Before and After Excluding a Corrupt Decay

To exclude a decay, press the Center Softkey labeled **Menu**, highlight **Exclude**, press **ENTER**. An “X” will appear next to the sample number to indicate it is excluded.

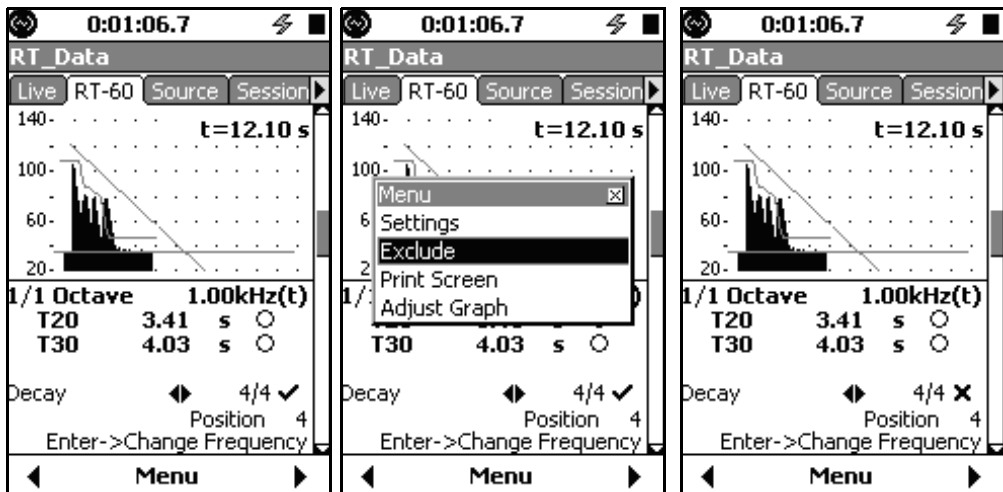

FIGURE 15-22 Steps to Exclude a Measurement

To re-include a decay that has been excluded, follow the same steps except highlight **Include** on the menu.

Manually Controlling the Internal Noise Source

When operating in the Room Acoustics instrument mode, the Model 831 provides an internal noise generator capable of outputting white or pink noise via the AC output jack.

The noise source is controllable from the Source display as follows:

- The **W** and **P** keys control the noise type.
- The **+** and **-** keys control the attenuation, which adjusts in 3dB steps.
- The **ENTER** key toggles the mute on and off.

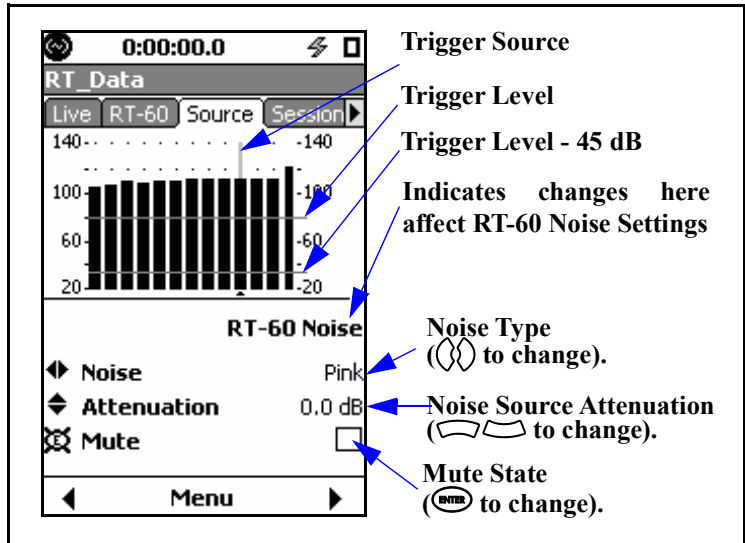

FIGURE 15-23 Source Display Summary

When the measurement method is set to Impulse or the Link to Source Display control is unchecked, the source is controllable independent of the RT-60 measurement.

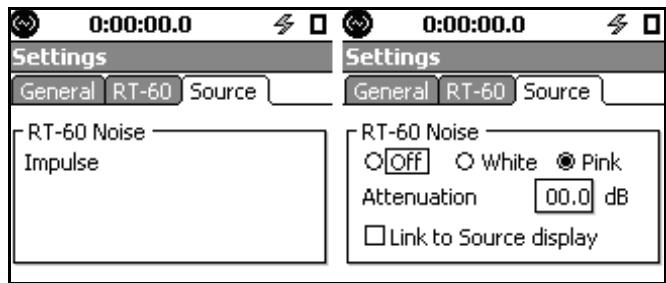

FIGURE 15-24 No Link to Source Display

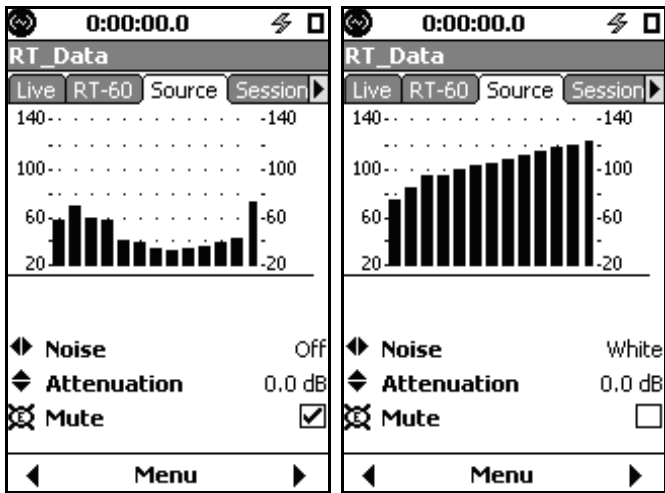

FIGURE 15-25 Independent Controls

When the measurement method is set to Interrupted Noise and the Link to Source Display control is checked, adjustments made on the display are reflected in the RT-60 Noise controls. In this case there is a notification under the graph and the trigger level and trigger source are shown.

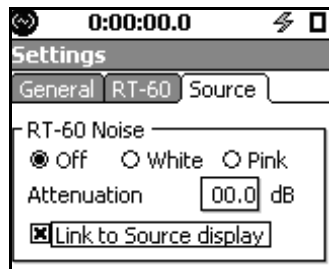

FIGURE 15-26 Link to Source Display

If the trigger source is set to Z or Mid Band, a cursor will not be shown.

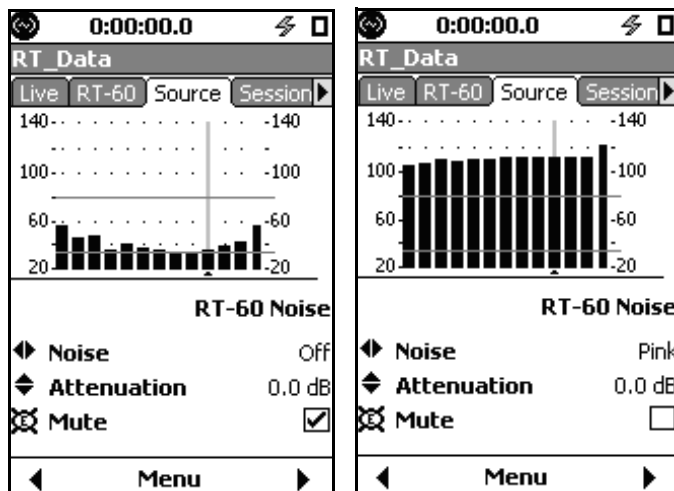

FIGURE 15-27 Linked Controls

Hints on Making a Good RT-60 Measurement

- Make sure the exit time is long enough to allow egress and any residual noise to die down
- Turn off your cell phone and remove other possible sources of sound contamination.
- Be quiet during the background level measurement (between the exit period and filling the pre-trigger buffer. See the “Measurement State Sequence” on page 15-5’.
- Minimize the ambient noise in the room by turning off the mechanical equipment (i.e., HVAC units).
- Close doors, windows, and partitions to reduce reverberant energy from adjoining areas.
- Use a sound source with repeatable amplitude and spectral content.
- Use the exclude feature when something goes wrong. It is a good idea to configure the instrument to take a few more decays than what is required just in case.
- Trigger near the maximum level. For interrupted noise method measurements, a few trial runs may be required to determine a good trigger point due to the requirement that the noise source level be above the trigger level for a specific duration (Build Time).

- Energize the room sufficiently. It may take multiple sound sources and measurements to characterize the decay times over the full desired spectrum.
- Make measurements at many different source-microphone combinations to improve the ensemble uncertainty. See the “Accuracy Grade section on page 13-28 for more information.
- Minimize what is in the room (see ISO 3382-2:2008(E) Section 4.1).
- ASTM E2235 requires working with a diffuse field (random incidence) microphone. You can select the correction FF->RI to adapt your microphone characteristics if needed.

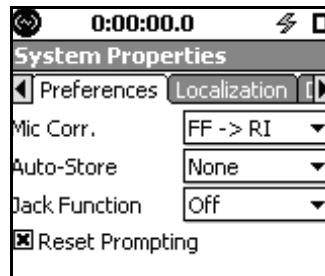

FIGURE 15-28 Microphone Correction

Customizing Measurements

From any of the pages on the **RT-60** tab, press the Center Softkey labeled **Menu**, highlight **Settings**, press **ENTER** to display the settings tabs shown below. These pages are used to modify the measurement parameters. The active parameter values shown represent the default values.

General Settings

Impulse and Interrupted Methods

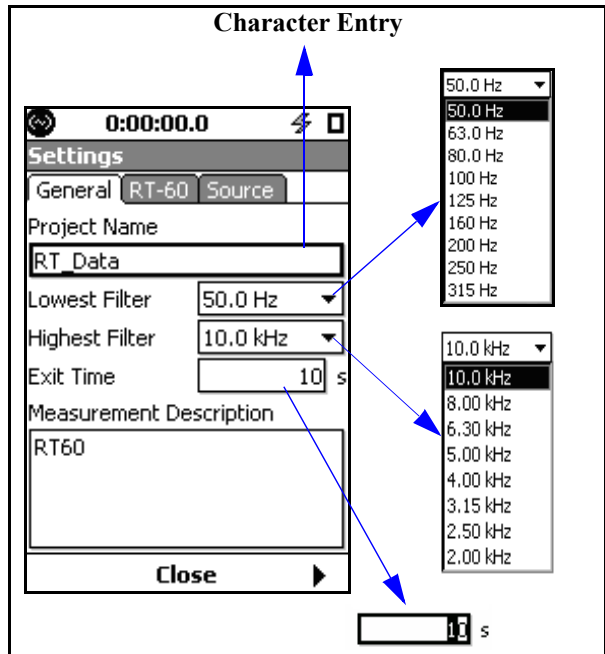

FIGURE 15-29 General Settings

Lowest and Highest Filters define the frequency range over which the measurement will be made.

The Exit Time is set to give the operator enough time to exit the room and to allow any residual noise to decay before starting a measurement and can range from 0 to 99 seconds.

RT-60 Settings

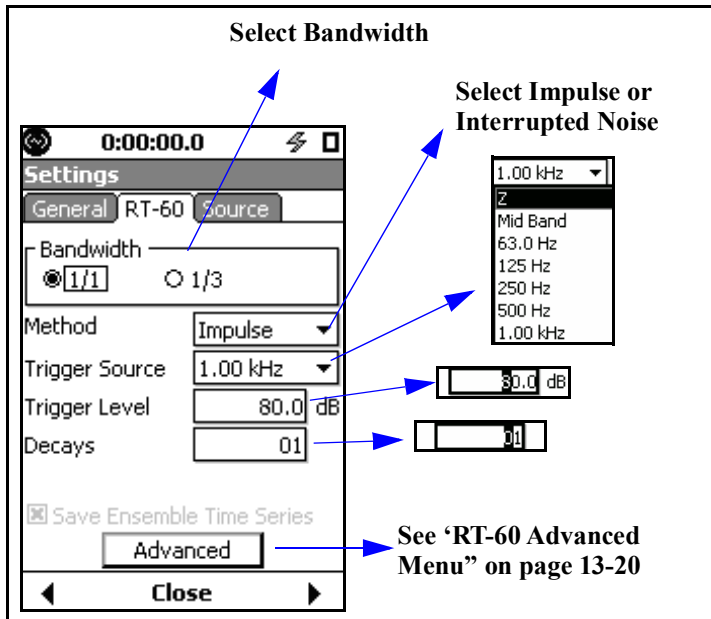

FIGURE 15-30 RT-60 Settings: Impulse Method

*The Trigger Source will also be limited to be between the Lowest and Highest filters (inclusive) as set on the **General** Tab shown in FIGURE 15-29.*

Method can be either Impulse or Interrupted Noise.

Trigger Source allows the user to select which filter output to use as the trigger source to when making a measurement and can be:

- Z-weighted
- Mid-Band: using the energy from the filters between 500 Hz and 2 kHz
- 1/1 or 1/3 octave filters, based on the bandwidth selected

Trigger Level is the signal level at which a reverberation time measurement is triggered. When using the Impulse method, data acquisition is triggered when the rising sound level exceeds the configured Trigger Level. When using the Interrupted Noise method, data acquisition is triggered when the decaying sound level drops to 5 dB below the configured Trigger Level.

Decays indicates the number of successive reverberation time measurements to take at a location. Once the measurement is started by pressing , the Model 831 will

begin making the measurement and automatically stop when the configured decay count has been reached.

RT-60 Advanced Menu

The advanced menu provides additional options that can be used to fine tune a measurement.

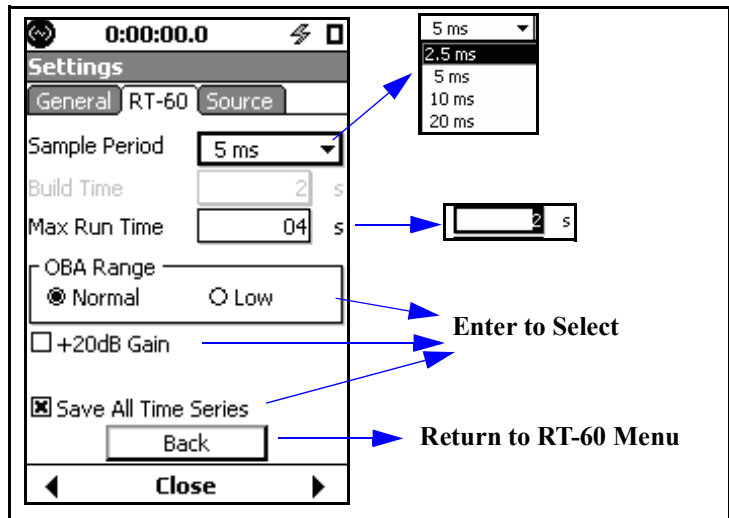

FIGURE 15-31 RT-60 Advanced Settings: Impulse Method

Sample Period sets the time interval between samples of the sound decay curves.

Max Run Time is used to set the post trigger run time. The maximum value is dependent upon the Sample Period as indicated by “Max Run Time vs Sample Period” on page 15-23.

Sample Period (ms)	Max Run Time (s)
20	19
10	18
5	9
2.5	4

Table 15 - 1 Max Run Time vs Sample Period

Care must be taken to ensure the decays are sampled adequately and this can be evaluated using some simple math. Consider that we have a reverberation time of 420 ms for a 60 dB decay. 20 dB is 1/3 of 60 dB, so for T20, we have $420 / 3 = 140$ ms. Sampling at 5 ms gives us $140 / 5 = 28$ data points. For T30 we have 210 ms or 42 data points.

Build Time is available when the method is set to Interrupted Noise. The Build Time is the time the noise level must be above the configured Trigger Level to sufficiently energize the room. For example, if the Build Time is set to five seconds, the sound source will be on for five seconds plus the time it takes for the sound level to reach the trigger level.

Use +20 dB gain only for Interrupted Noise since impulses quickly exceed 120 dBZ.

Source Menu

Impulse Method

The RT-60 noise controls are unavailable when using the Impulse method.

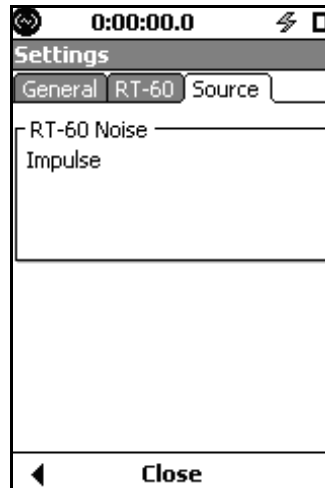

FIGURE 15-32 Source Setting: Impulse Method

The impulse signal is generated externally, i.e., with a starter pistol, a balloon, etc.; there is nothing to configure on this page.

Interrupted Noise Method

Whether using an external source or the internal source, the Model 831 is designed to automate and simplify the process by making measurements based upon triggers.

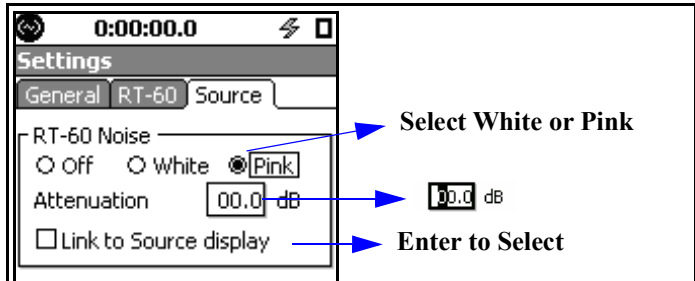

FIGURE 15-33 Source Settings: Interrupted Noise Method

The signal used to energize the room can be generated by an external sound source or using the internal noise source of the Model 831. If using an external source, select “Off”. If using the internal noise source, select “White” or “Pink” noise.

WARNING!

Making interrupted noise RT-60 measurements using an internal noise source involves connecting an amplifier or speaker system to the AC output. Make sure to disable the AC/DC Out preference, or turn off your amplifier or speaker system, before switching to the SLM mode. Otherwise, you may damage your amplifier or speaker system, as well as your hearing, from the resulting feedback.

The Model 831 outputs the noise signal via the AC output connector. An external amplifier and speaker system is needed to sufficiently energize a room.

Attenuation is used to reduce the output signal from the Model 831 in instances where the level might overload the amplifier input.

The Link to Source Display check box, when checked, will allow the user to control these settings in real-time from the source display.

Storing Data

Press the  key to store data.

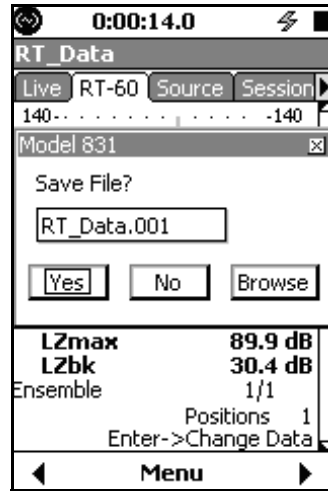

FIGURE 15-34 File Save Dialog



Viewing Stored Data

The stored data displays are the same regardless of the method used for the measurement.

Note: The Data Explorer only shows files from the current instrument mode.

Following a measurement, the stored data can be viewed on the **RT-60** tab pages as follows:

- RT-60 Spectra
- RT-60 Decay Curve
- Excitation Levels
- Quality Summary (two pages for 1/3 octave data)
- Quality Detail
- Accuracy Grade

Use the Data Explorer utility to view stored measurements on the 831. Data Explorer is opened by pressing the  key and then selecting the icon labeled “Data Explorer”. When this utility opens, it will display the saved files. To open one of the files, highlight the file and press . The data can now be viewed just as was outlined in the “Viewing and Analyzing Results” section. One exception is that the data

cannot be edited, therefore individual decays cannot be included or excluded from the ensemble.

Quality Indicators

The Model 831 provides a variety of measurement “quality indicators” using criteria described in ISO 3382-2:2008(E). For more information, including the equations used to calculate each metric, please refer to ISO 3382-2:2008(E). Each quality indicator is described below, and Table 3-2 shows the criteria for being considered “Good”, “Fair”, or “Poor”.

	● = Good	◐ = Fair	◑ = Poor
BT	>16	NA	≤ 16
BK	≥ 35 dB (T20) ≥ 45 dB (T30)	NA	< 35 dB (T20) < 45 dB (T30)
NL	≤ 5‰	5‰ < NL ≤ 10‰	> 10‰
Cu	0% ≤ Cu ≤ 5%	5% < Cu ≤ 10% -5% < Cu < 0%	> 10% ≤ -5%
SD	≤ 5%	5% < SD ≤ 10%	> 10%
NA = Not Applicable			

Table 15 - 2 Quality Indicator Criteria

BT – BT is the product of the filter bandwidth and the T20 or T30 decay time for that frequency. BT is used to determine if the measured reverberation time may have been influenced by the filter response time. See ISO 3382-2:2008(E) Section 7.3 equation 4.

BK – BK is a measure of the dynamic range between the excitation signal and the background noise level. BK is calculated from LZmax when using the Impulse method, and from LZeq when using the Interrupted Noise method. See ISO 3382-2:2008(E), Sections 5.2.1 and 5.3.2.

NL – NL is the degree of non-linearity of the T20 or T30 portion of the decay curve, and is reported as per mill ‰ (parts per thousand) deviation from perfect linearity. See ISO 3382-2:2008(E), Annex B.2.

Cu – Cu is the degree of curvature, and is a comparison of the T20 and T30. Cu is expressed as the percentage deviation from being perfectly in-line. See ISO 3382-2:2008(E), Annex B.3.

SD – SD is the standard deviation of the measurement results for the T30 or the T20 decay times. See equations 2 and 3 in ISO 3382-2:2008(E), Sections 7.1. For impulsive excitation, $n = 10$ is used as defined in section 7.2

Accuracy Grade

ISO 3382-2:2008(E) describes three methods of differing measurement uncertainty as follows:

Survey Method

The survey method is appropriate for the assessment of the amount of sound absorption for noise control purposes, and survey measurements of the airborne and impact sound insulation. It should be used for measurements in ISO 10052. Survey measurements are made in octave bands only. The nominal accuracy is assumed to be better than 10% for octave bands.

Make measurements of the reverberation time for at least one source position. Find the average of results from at least two source-microphone combinations, see Table 15 - 3.

Engineering Method

The engineering method is appropriate for verification of building performance for comparison with specification of reverberation time or room absorption. It should be used for measurements in ISO 140 (all parts) with remarks to reverberation time measurements. The nominal accuracy is assumed to be better than 5% in octave bands and better than 10% in one-third octave bands. See Table 15 - 3.

Measure reverberation time two or more times for each source-microphone combination. At least six independent source-microphone combinations are required, see Table 15 - 3 'Minimum Number of Positions and Measurements'.

Precision Method



The precision method is appropriate where high measurement accuracy is required. The nominal accuracy is assumed to be better than 2.5% in octave bands and better than 5% in one-third-octave bands.

Measure reverberation time three or more times for each source-microphone combination. At least twelve independent source-microphone combinations are required, see Table 15 - 3 'Minimum Number of Positions and Measurements'.

	Survey	Engineering	Precision
Source-microphone combinations	2	6	12
Source-positions	≥1	≥2	≥2
Microphone-positions	≥2	≥2	≥3
No. decays in each position (interrupted noise method)	1	2	3
Method	Impulse or Interrupted	Interrupted	Interrupted
Filter bandwidth	1/1	1/1 or 1/3	1/1 or 1/3
Frequency Range (minimum)	250 Hz to 2 kHz	125 Hz to 4 kHz (1/1) 100 Hz to 5 kHz (1/3)	
Standards	ISO 10052	ISO 140	

Table 15 - 3 Minimum Number of Positions and Measurements

Return to Sound Level Meter Mode

A shortcut is to press the  key and then the  key to select the SLM icon.

When the RT-60 mode is active, select the SLM icon in the Control Panel to return to Sound Level Meter mode, as shown in Figure 15-35.

Changing modes using the icon on the control panel loads the setup that was previously in use for that mode.



FIGURE 15-35 SLM Icon

Sound Recording

This chapter describes the digital sound recording features associated with the optional firmware 831-SR. This feature is not intended for recordings over extended time periods, such as “all day” recordings. We recommend the use of an external recorder connected to the Model 831 AC output for these types of applications.

Sound Recording Types

There are four types of sound recordings described in this chapter:

- Manual Sound Recording: described in “Manual Sound Recording” on page 16-7
- Marker Initiated Sound Recordings: described in “Marker Initiated Recording” on page 16-9
- Event Sound Recordings (Option 831-ELA required): described in “Event Sound Recording” on page 16-14
- Measurement Sound Recordings (Option 831-ELA required): described in “Measurement History Sound Recording” on page 16-18:

The main difference between them is how the recordings are initiated. With manual and marker initiated recordings, the user must initiate each recording. With event recording, the exceedance of a threshold sound level automatically initiates the recording. With measurement recording, a segment at the beginning of each measurement history record is automatically recorded. Note that both event and measurement sound recordings can be enabled at the same time.

Sound Recording Setup

The Sound Recording feature of the Model 831 implements the digital recording of the sound signal output from the measurement microphone. Regardless of the sound recording type(s) to be utilized, the basic recording parameters are set as described in this section.

Note that the default values for these parameters are as shown in FIGURE 16-1.

Sound Recording is setup using the **Sound** tab of the Measurement Setup View, as shown in Figure 16-1.

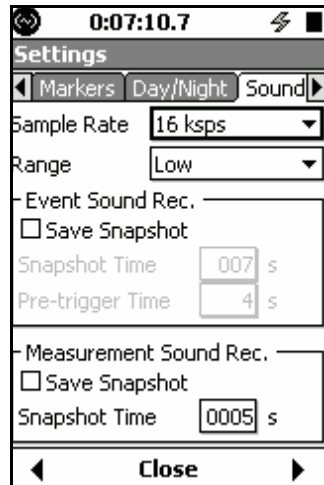

FIGURE 16-1 Sound Recording Setup Menu

Sample Rate

The Sound Recorder feature of the Model 831 is a powerful tool for source identification and for advanced analysis. The sample rates used for source identification are 8k, and 16k sps (samples per second) and the sample rates used for advanced analysis are 24k and 48k sps.

Sample Rate Selection

The Sample Rate data field is used to select the sample rate for the digital data recording. Highlight this field and press **ENTER** to open the Sample Rate Menu shown in Figure 16-2

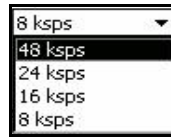

FIGURE 16-2 Sample Rate Menu

Highlight the desired sample rate and press **ENTER** to make a selection.

Source Identification Setup

Sample rates above 16k sps are not available for source identification recording (see Restrictions below)

The 8k sps setting is generally sufficient for a quality sound recording that can be used for source identification and provides the lowest memory consumption. The sound recording can be recorded automatically by enabling the Event Recorder (see “Event Sound Recording” on page -14), Measurement History (see “Measurement History Sound Recording” on page -18) or manually by enabling Markers sound recording and then activating a marker (see “Manual Sound Recording” on page -7).

Advanced Analysis

Be sure to disable the Time History, Event History and Marker Sound Record options in order to use the sound recorder at 24k and 48k sps (see restrictions below).

To record sound information for advanced analysis, enable the Measurement History and the Measurement Sound Recorder settings (see “Measurement History Sound Recording” on page -18). The sample rate can be 8k, 16k, 24k or 48k sps, with 48k sps offering the highest frequency bandwidth.

When a measurement is performed by pressing the Run key (or at a programmed interval), a sound recording file will be created for the duration specified (unless stopped manually prior to a complete duration). The resulting sound recording file can then be downloaded and exported with G4 LD Utility. The exported wave file can be analyzed with a software package such as Mat Lab.

Restrictions

It is not possible to use the sound recorder at 24k and 48k at the same time as the Time History, Event History or Marker

Sound Recording options. When any of these features are activated while the sample rate is set to 24k or 48k, the Setting Conflict message shown in FIGURE 16-3 will appear.



FIGURE 16-3 Setting Conflict Message

The Sound Recorder Sample Rate will be automatically set to 8k sps if Yes is chosen, or, the feature will not be enabled if No is chosen.

If any of the History, Event History or Marker Sound Record options are enabled, the list of sound recorder Sample Rate options will be 8k and 16k sps, as shown in the next image, and sound record is enable for source identification.

Effect of Sample Rate

A formula for calculating the memory size of sound recordings is given in the section “Sound Recording” on page 25-3.

A general rule of thumb is that the playback of a digital sound recording will provide accurate reproduction of frequency content up to 0.48 times the recording sample rate. Thus, a 48 kHz sample rate would provide a recording having good fidelity over the complete human hearing range. The drawback is that the size of the recording data block is proportional to the sample rate. If the upper frequency content of the signal is known, the sample rate can be reduced to match it. For example, in terms of comprehension, human speech would be satisfactorily reproduced using a sample rate of 8 kHz.

Range

There are two amplitude ranges used for sound recording:

- Low (default value)
- High

The following section provides guidance in the selection of range setting.

These have a 33 dB gain difference between them. They are similar to the two ranges available for use with the 1/1 and 1/3 octave band filters, described in “OBA Range Setting” on

page 4-7. To select the range, highlight the Range field and press **ENTER** to open the Range Menu shown in Figure 16-4.

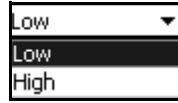

FIGURE 16-4 Range Menu

Highlight the desired sample rate and press **ENTER** to make a selection.

Sound Recording Range

A/D Convertor

The 16-bit A/D convertor used for sound recording provides a measurement range of approximately 90 dB. This means that it is capable of recording sound signals whose amplitudes are no more than 90 dB below the level at which the instrument will overload. When the overload level is expressed in terms of peak level and the signal level as root-mean-square (rms), this range is actually 93 dB. Note, however, that in practice this lower limit can be limited by the internal noise floor of the instrument.

Peak Overload/Noise Level

The **Sensitivity** tab, as described in the section “Sensitivity Tab” on page 8-13, can be used to determine the peak overload level and Z-weighted noise level on of the Model 831. Levels are indicated for specific instrument setups using microphones having given sensitivities. Since the Model 831 can be setup to have a gain of either 0 or 20 dB, as described in “20 dB Gain” on page 4-5, there are two possible values of peak overload level and noise level for a given microphone.

Sound Recording Range Calculation

When the peak sound level and noise level values have been determined for the Model 831 using a specific microphone, the useful sound recording range can now be determined as shown in TABLE 16-1. In this example, the peak sound levels and noise levels correspond to a microphone having a nominal sensitivity of 50 mV/Pa.

Step 1 For each combination of Instrument Gain (0 or 20 dB) and (Low or High), enter the peak overload level values in the 3rd row. For the High range use the values determined as described in “Peak Overload/Noise Level” on page 16-5. For the Low Range, subtract 33 dB from the High range value.

Step 2 For each column, subtract 93 dB from each peak overload level to obtain the lower level of A/D range and enter this in the 4th row.

Step 3 For each column, enter the value of noise floor in the 5th row.

Step 4 For each column, determine the sound recording range. The lower limit will be the larger of the lower level of A/D range and the instrument noise floor. The upper limit will be the peak overload level

Instrument Gain	0 dB	0 dB	20 dB	20 dB
Range	High	Low	High	Low
Peak Overload Level	143 dB	110 dB	123 dB	90 dB
Lower Level of A/D Range	50 dB	17 dB	30 dB	-7 dB
Instrument Noise Floor	23 dB	23 dB	21 dB	21 dB
Sound Recording Range	50 - 143 dB	23 - 110 dB	30 - 123 dB	21 - 90 dB

TABLE 16-1 Sound Recording Range Calculation: Microphone Sensitivity of 50 mV/Pa

The quality of a sound recording will depend upon the levels of sound being recorded and the choice of instrument gain and range used in the instrument setup. Should the sound level exceed the peak overload level, there will be clipping of the signal which will introduce distortion into the playback. If the sound level drops below the lower limit of the sound recording range, its signal will be lost in noise during playback. Thus, the selection of instrument gain and

recording range should be made to meet the characteristics of the sounds being recorded.

When measuring very loud noise levels (gun blasts, sonic booms, space shuttle lift off) use the High range. When trying to identify quiet noise sources (crickets, airplanes flying at 30000', national park soundscape studies, people talking in the vicinity of the microphone) and don't mind the very loud noises being clipped (distorted), use the Low range. The low range is like turning up the volume on a tape recorder input; if the sound gets too loud it will clip and distort the recording but you will be able to hear the quiet noises more clearly. Turning the volume control down may drop the quiet sounds below the background noise and make them inaudible, but the louder sounds will be heard with greater fidelity.

Manual Sound Recording

*Sound recordings can only be made when the instrument is running. If the unit is stopped, the **Rec** softkey will not appear.*

A manually initiated sound recording can be made from any of the following screens, as illustrated in

- Profile Page of the Live tab
- Session Log tab (while running)
- Time History tab (while running)

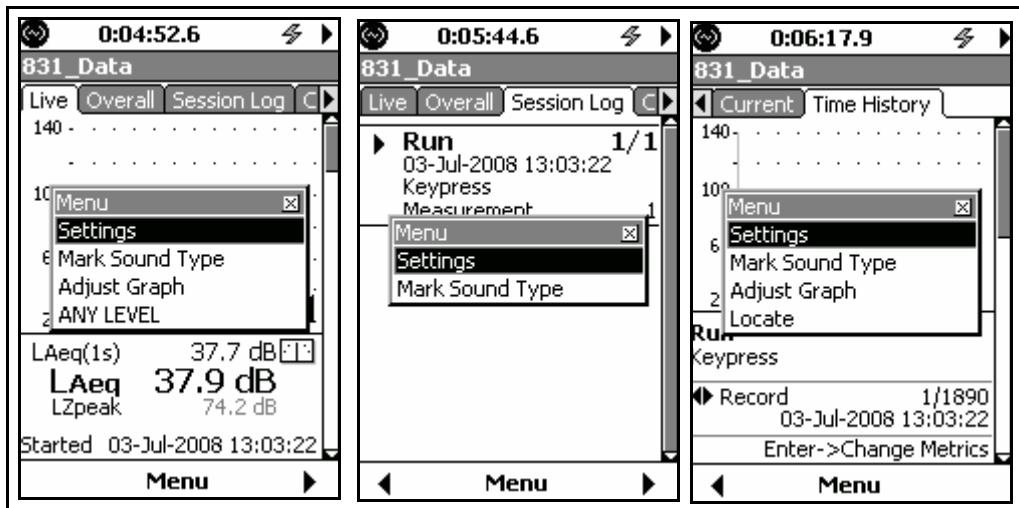

FIGURE 16-5 Screens for Initiating a Manual Sound Recording

Highlight Mark Sound Type and press **ENTER** to obtain the Markers Setup Menu shown in FIGURE 16-6.

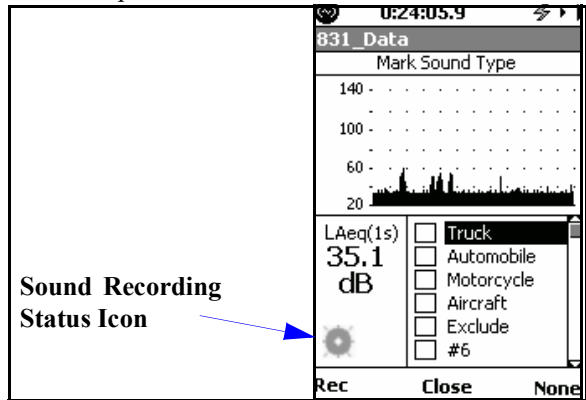

FIGURE 16-6 Markers Setup Menu

Initiate a Manual Sound Recording

When a recording is in progress, the Recording Status Icon, shown grayed out in Figure 16-6, will become active, as shown in Figure 16-7.

Press the **Rec** softkey to initiate a sound recording. The recording will continue until the recording is manually stopped.

When the recording has begun, the **Rec** softkey will be replaced by a **Stop** softkey, as shown in FIGURE 16-7

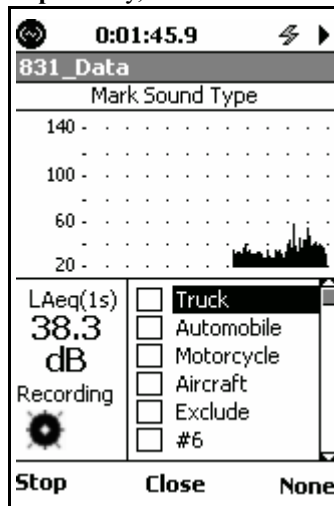



FIGURE 16-7 Markers Setup Menu, Sound Recording in Progress

Stop a Manual Recording

Pressing any of the following keys will stop the sound recording:

The sound recording will also stop when the memory is full. Note that if left recording, the memory will fill and create very large files that will be time consuming to download and playback.

- Stop softkey
- None softkey
- Close softkey
-  (STOP/STORE) key

Marker Initiated Recording

Markers are also with Time History measurements, described in Chapter 11 “Time History” on page 11-1, which requires the optional firmware 831-LOG.

In order to identify the source or some other characteristic of a sound being recorded, the user can define up to ten markers and attach one or more marker(s) to a sound recording. These markers can then be used to initiate sound recordings from the markers setup menu.

Markers Setup

Note that the default values for these parameters are as shown in FIGURE 16-8.

Markers are setup using the **Markers** tab of the Measurement Setup View, as shown in Figure 16-8.

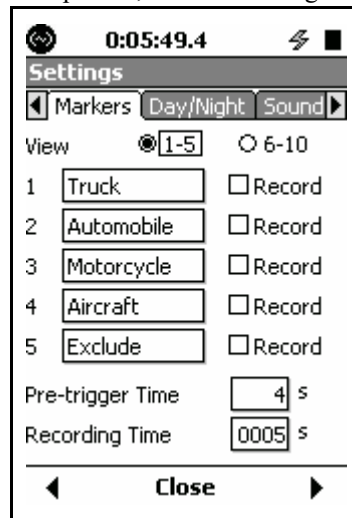

FIGURE 16-8 Markers Setup 1-5

There are five markers with names predefined for convenience shown in this figure. Any of these names can be changed by the user. To view markers 6 -10, highlight the 6 - 10 text line and radio buttons and press **ENTER** to obtain the display shown in Figure 16-9.

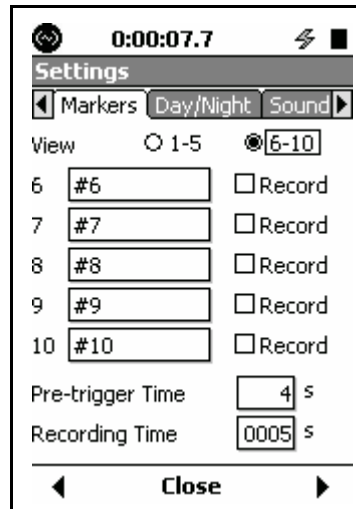

FIGURE 16-9 Markers Setup 6-10

Naming a Marker

Note that the process of naming markers is simplified by using the 831 Utility software.

Highlight the field of the marker to be named and press **ENTER**. This will produce a cursor which can be moved left and right to different digit positions in the data field using the 4 and 6 keys, as shown in Figure 16-10.



FIGURE 16-10 Marker Name Field

Enter a marker name and press **ENTER** to conclude the process.

Setting a Marker to Record

In order to utilize one or more markers to initiate a sound recording, we set each of the markers we would like to use to initiate a recording to **Record**. This is done by highlighting the marker and pressing **ENTER**. In FIGURE 16-11,

we have created a setup whereby a recording can be initiated by either the Truck marker or the Motorcycle marker



FIGURE 16-11 Two Markers Set To Record

Recording Time Setup

Sound recordings initiated by markers will record for a user-defined recording time following the initiation of the recording. In addition, the user can select to have each recording also include the sound signal which existed for a user-defined time period prior to the initiation of the recording, called the pre-trigger time.

Pre-trigger Time

The range of the manual recording pre-trigger time is 0 to 9 seconds.

If it is desired that the recorded signal include a segment of sound which occurred prior to the initiation of the recording, set the Pre-trigger to the length of that time segment.

To enter the Pre-trigger Time, highlight the Pre-trigger data field and press **ENTER** to open the Pre-trigger Time data field and cursor shown in Figure 16-12.



FIGURE 16-12 Entering Pre-trigger Time for Event Sound Recording

Enter the desired value and press **ENTER** to conclude the process.

Recording Time

Note that the maximum value of Recording Time which can be entered is 9,999 seconds. However, the maximum time of an actual recording may be limited by the sample rate and the memory size.

The Recording Time is the duration of each recording. To enter the Recording Time, highlight the Recording Time data field and press **ENTER** to open the Recording Time data field and cursor shown in FIGURE 16-13.

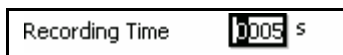

FIGURE 16-13 Entering Recording Time for Sound Recording

Enter the desired value and press **ENTER** to conclude the process.

Initiating a Recording

A marker initiated sound recording is started using the same menu used to initiate a manual recording. Follow the same procedure described in “Manual Sound Recording” on page 16-7 to open the menu shown in FIGURE 16-14.

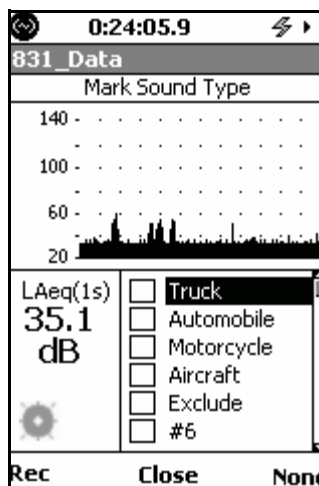



FIGURE 16-14 Markers Setup Menu

Set Marker to On

To initiate a sound recording, set **On** any marker which had been designated **Record**, as described in “Setting a Marker to Record” on page 16-10. To do this, highlight the name of

the desired marker and press  to place a check in the check box to the left of the name, as shown in FIGURE 16-15.

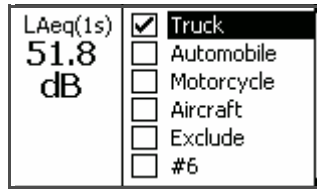

FIGURE 16-15 Marker Set to On

Press the **Close** softkey, shown in FIGURE 16-14, to complete the process of setting the Marker to **On** and to exit from the Mark Sound Type Menu. This will initiate the recording.

When a recording is in progress, the Recording Status Icon, shown grayed out in Figure 16-6, will become active.

The recording will continue for the programmed Recording Time, even if the maker is set **Off** before that amount of time has passed.

Once one or more markers have been set to **On** and the recording initiated, they should all then be set to **Off** so that a subsequent recording may be initiated at a later time.

Set Markers to Off

To set all markers to **Off**, repeat the steps used to open the Mark Sound Type Menu, shown in FIGURE 16-14. Press the **None** softkey to set all Markers to **Off** and press the **Close** softkey.

All markers will also be set to **Off** if the measurement is stopped by pressing the  key.

Event Sound Recording

Sound recordings can be made automatically upon exceedance of the event threshold levels (see “Triggers Tab” on page 4-11) without the optional 831-ELA firmware enabled. However, to have data stored for these exceedance events (see Chapter 13 “Event History” on page 13-1) the 831-ELA firmware must be enabled.

Event Sound Recording is used to automatically make a sound recording for each exceedance-based event. Highlight the Save Snapshot text field in the Event Sound Recording section of the display (Figure 16-1 on page 16-2) and press the **ENTER** key to place a check in the check box. This will modify the Event Sound Recording section of the Sound Recording Setup Menu as shown in Figure 16-16

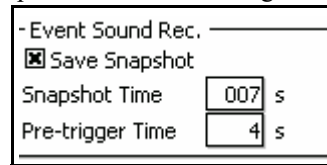

FIGURE 16-16 Event Sound Recording Menu

Snapshot Time

The maximum value of Snapshot Time which can be entered is 999 seconds. However, the maximum time of an actual recording may be limited by the sample rate and the memory size.

The Snapshot Time is the duration of each Event Sound Recording. To enter the Snapshot Time, highlight the Snapshot data field and press **ENTER** to open the Snapshot Time data field and cursor shown in Figure 16-17.

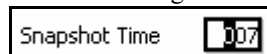

FIGURE 16-17 Entering Snapshot Time for Event Sound Recording

The snapshot time must be greater than the event minimum duration, as set in “Minimum Duration” on page 13-2, in order for a recording to be made.

Enter the desired value and press the **ENTER** key to conclude the process.

Pre-trigger Time

If it is desired that the recorded signal include a segment of time which occurred prior to the exceedance-based trigger, set the Pre-trigger Time to that value. Highlight the Pre-trigger data field and press **ENTER** to open the Pre-trigger Time data field and cursor shown in Figure 16-18.

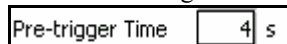

FIGURE 16-18 Entering Pre-trigger Time for Event Sound Recording

Enter the desired value and press **ENTER** to conclude the process.

Note that the maximum value of Pre-trigger Time is 9 seconds.

Additional Considerations

The implementation of event sound recordings involves the interaction of parameters from both the **Event History** and **Sound** tabs as follows:

Event Time History Setup

- Minimum Duration
- Continuation Period

Sound Setup

- Snapshot Time
- Pre-Trigger Time

Several examples of how these parameters effect the length of the sound recording are presented in the following diagrams.

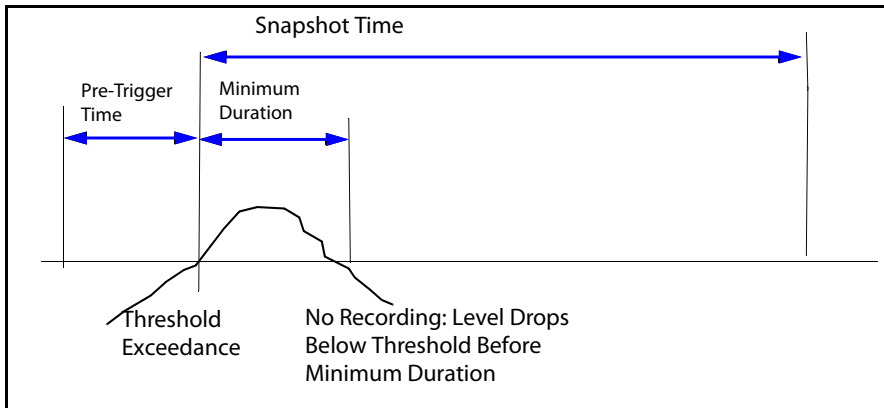

FIGURE 16-19 Less Than Minimum Duration: No Event/No Recording

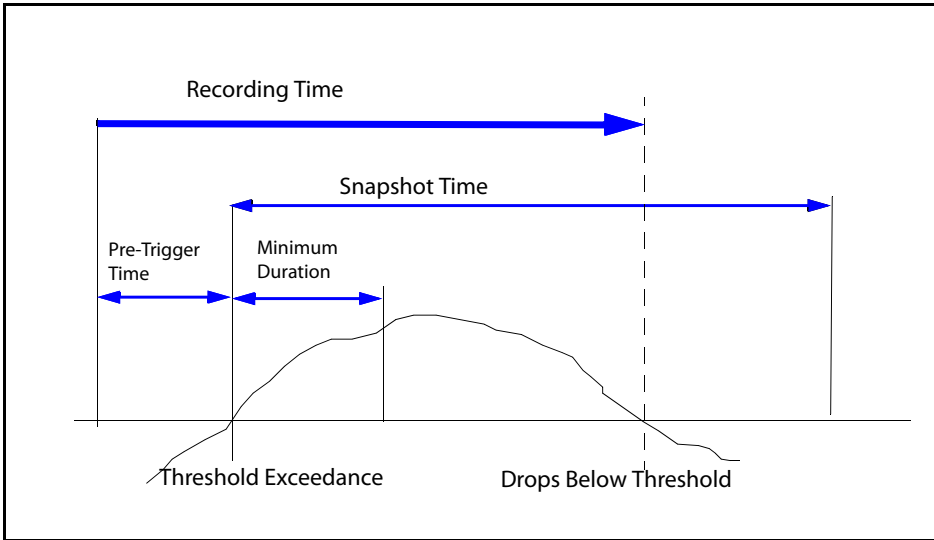

FIGURE 16-20 Stops When Level Drops Below Threshold: Valid Event/Recording

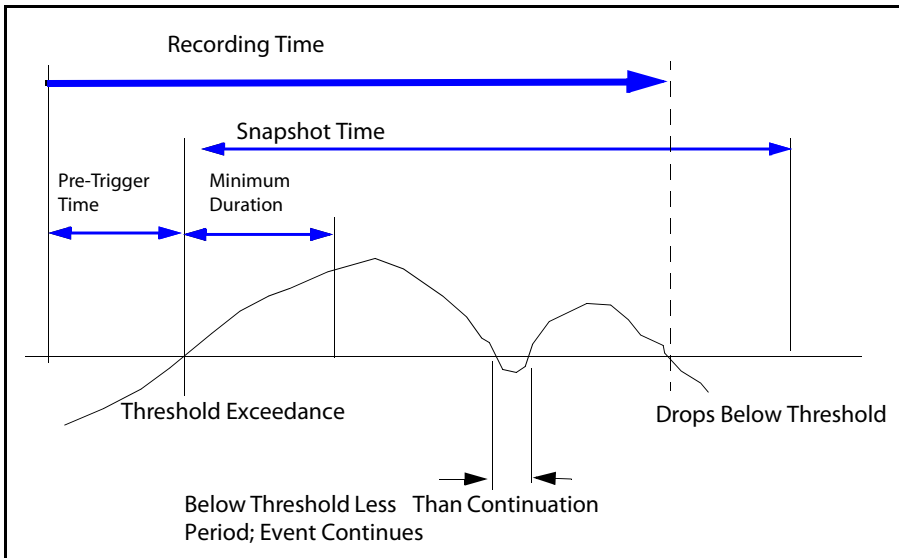

FIGURE 16-21 Stops When Level Drops Below Threshold After Continuation: Valid Event/Recording

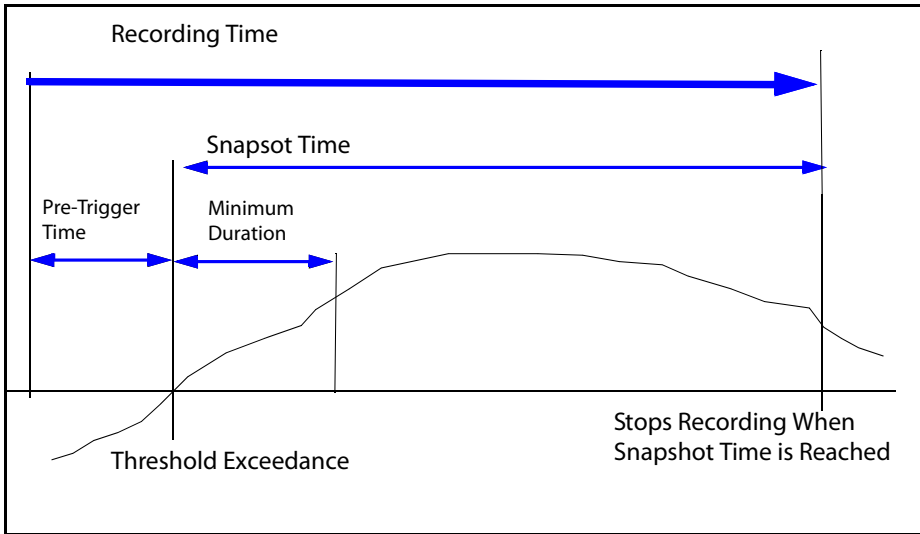

FIGURE 16-22 Stops When Reaches Snapshot Time: Valid Event/Recording

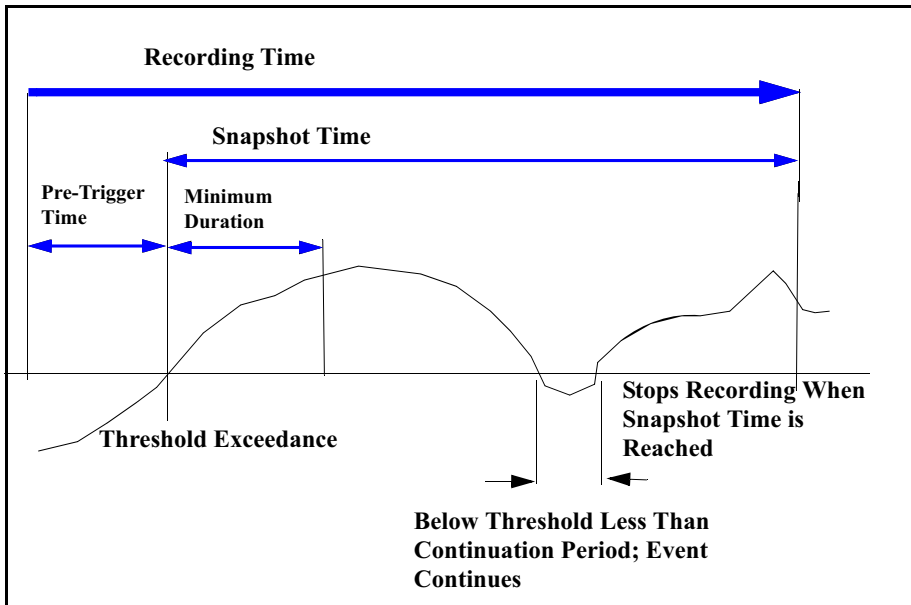

FIGURE 16-23 Stops When Reaches Snapshot Time After Continuation: Valid Event/Recording

Pre-trigger Time/Minimum Duration Criterion

Due to the manner in which the data are stored, the event pre-trigger time plus the minimum event duration must be less than the criterion time shown in TABLE 16-2, which is a function of the selected sample rate.

Sample Rate, kHz	Criterion Time, s
48	10
24	18.9
16	18.9
8	18.9

TABLE 16-2 Pre-Trigger Time/Min Duration Criterion

Recording Status Icon

When a recording is in progress, the Recording Status Icon, shown grayed out in Figure 16-6, will become active. The icon does not show when the pre-trigger buffer is being filled, only when the level is over the defined exceedance trigger level,

Measurement History Sound Recording

Measurement History must be enabled on the Settings > Control tab to activate Measurement Sound Recording.

Scroll to the **Measurement Sound Rec.** area, select **Save Snapshot**, and press **ENTER**, as shown in Figure 16-24.

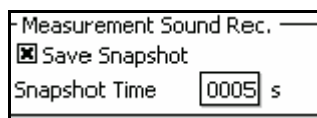

FIGURE 16-24 Measurement Sound Recording

Snapshot Time

Note that the maximum value of Snapshot Time that can be entered is 9,999 seconds. However, the maximum time of an actual recording may be limited by the sample rate and the memory size.

The Snapshot Time is the duration of each Measurement Sound Recording. To enter the Snapshot Time, highlight the Snapshot data field and press **ENTER**. This will produce a cursor which can be moved left and right to different digit positions in the data field using the **4** and **6** keys.

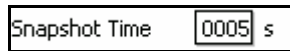

FIGURE 16-25 Entering Snapshot Time for Measurement Sound Recording

Enter the desired value and press the **Close** softkey. Press **ENTER** on the **Yes** button to apply the changes.

Recording Status Icon

When a recording is in progress, the Recording Status Icon, shown grayed out in Figure 16-6, will become active.

Combined Sound Recordings

Only one sound recording can be made at a time. As a result, should a sound recording be initiated, manually or automatically, while a sound recording is already in progress, the original sound recording will continue. However, should the parameters for the second recording call for that recording to be concluded at a time later than that defined by the parameters of the first recording, the original recording would continue until the parameters of the second recording are satisfied.

More generally, when a sound recording is initiated, a counter is begun to define when that recording should stop. If during that recording one or more additional recordings are initiated, a counter will be begun for each, even though the same recording is continued rather than a series of separate recordings. The original recording will then stop when the counters of all recordings have counted down to zero, indicating that the time interval of that recording encompasses all the data which would have been recorded by those separate recordings.

Sound Recording Playback

When using the SLM Utility-G3 and G4 software, sound recordings can be played back through the computer speakers and saved as Windows .wav files.

In this section we present several methods for playing back sound recordings from the Model 831 and listening to them using headphones connected to the AC/DC Output and Headset Jack.

Playback from Session Log

All sound and voice recordings are listed in order of recording time on the **Session Log** tab, as shown in FIGURE 16-13.

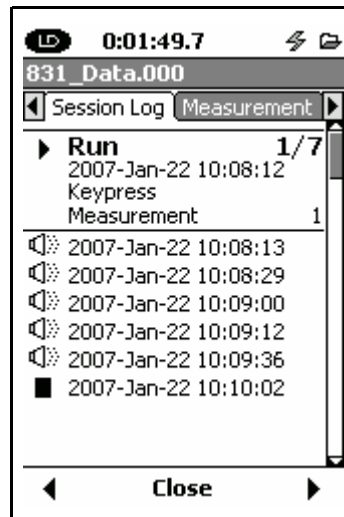





FIGURE 16-26 Sound Recordings on Session Log

Any of these recordings can be played back by using the  and  keys to highlight the desired recording and pressing .

Recording Type Indication

The type of each recording can be identified by highlighting the specific recording file as indicated below.

Manual Sound Recording

Sound recordings which have been recorded manually using the Marker function will be indicated by the text “Markers Record” as shown in FIGURE 16-27.

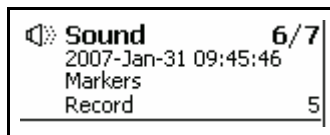

FIGURE 16-27 Manual Sound Record

Measurement Sound Recording

Sound recordings implemented automatically at the beginning of Measurement History periods are identified by the text “Measurement Record” as shown in FIGURE 16-28.

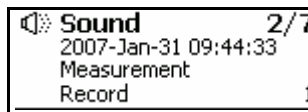

FIGURE 16-28 Measurement Sound Record

Noise Event Sound Recording

Sound recordings implemented automatically as a result of noise events are identified by the text “Event Record” as shown in FIGURE 16-29.



FIGURE 16-29 Noise Event Sound Record

Combined Recording

A combined sound recording, described in “Combined Sound Recordings” on page 16-19, is identified by the recording type of the first recording which initiated the recording process.

Voice Recording

Voice recording, discussed in Chapter 10 “Voice Recording” on page 10-1, will also appear with a speaker logo in the Session Log. When highlighted, these can be differentiated from sound recordings by the heading “Voice” instead of “Sound”, as shown in FIGURE 16-30.

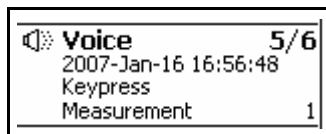

FIGURE 16-30 Voice Annotation Record

Playback from Data Display Screen

This is an alternative playback method to using the Session Log. Note that this playback method can only be used prior to saving the measurement.

In addition to playback from the **Session Log** tab, both Event Sound Recordings and Measurement Recordings can also be played back from their first data display screens as described below.

Event Sound Recordings

When Event Sound Recording had been enabled during the measurement period, a sound recording icon will appear along with the Leq data for each event record, as shown in FIGURE 16-31.

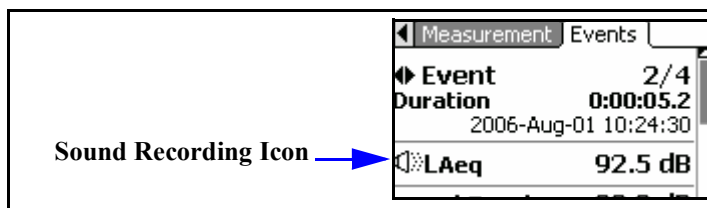

FIGURE 16-31 Sound Recording Playback; Event Recordings

To play back the recording for this record, press the Menu key to obtain the menu shown in FIGURE 16-32

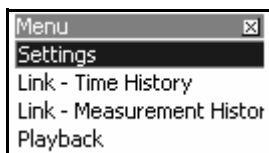

FIGURE 16-32 Menu

*The Model 831 must be stopped in order to perform a playback in this manner. If the instrument is running when the playback is attempted, a screen will be displayed to permit the user to stop the instrument. Select **Yes** and the playback will begin immediately.*

Highlight **Playback** and press  to playback this sound recording.

Measurement Recordings

When Measurement Sound Recording had been enabled during the measurement period, a sound recording icon will appear along with the Leq data for each measurement history event record, as shown in FIGURE 16-33.



 Leq	85.9 dB
Lmax	94.2 dB

FIGURE 16-33 Sound Recording Playback; Measurement Recordings

To play back the recording for the displayed record, press the Menu key to obtain the menu shown in FIGURE 16-34

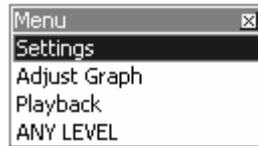

FIGURE 16-34 Menu

*The Model 831 must be stopped in order to perform a playback in this manner. If the instrument is running when the playback is attempted, a screen will be displayed to permit the user to stop the instrument. Select **Yes** and the playback will begin immediately.*

Highlight **Playback** and press  to play back this sound recording.

Data Explorer

This chapter describes how to view data and files in the Data Explorer of the Model 831 Sound Level Meter.

Control Panel - Data Explorer



To activate the Data Explorer Page, press the  (TOOLS) key. Highlight the Data Explorer icon as shown in FIGURE 17-1.



FIGURE 17-1 Control Panel

Press  (ENTER) to open the Data Explorer tabs.

Press the **Close** Softkey to exit.

Data Explorer

Data Explorer shows a directory of all saved data files. Data files saved to internal memory are listed first, followed by data files saved on the USB memory device. The files saved to the USB device are denoted by a small flash memory icon as shown in FIGURE 17-2. The scroll bar indicates the relative position in the list of data files. There may be more data files in the directory than are displayed on this page. All files may be viewed by scrolling through the list.

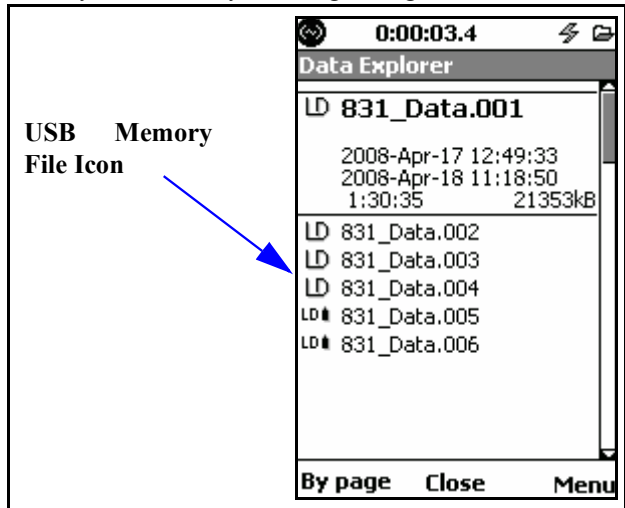



FIGURE 17-2 Data Explorer

Note that the USB Host Port must be set to On, as described in ‘USB Host Port’ on page 18-14, in order for the Data Explorer to access data saved on a USB memory device.

Using the  and  keys you can scroll through the list of data files. As each file is selected you get an expanded view of the directory entry showing:

- File name
- Start date and time of measurement
- End date and time of measurement
- Run time of measurement
- Size of Measurement File



Scrolling

There are two modes of scrolling available:



- By item
- By page

Pressing the left softkey will toggle between these two modes.

By item

“By item”, shown in FIGURE 17-2, is the default scrolling mode. Using this mode, the window presenting information for the selected file moves down or up one file at a time when pressing the  or  keys, respectively.

By page

When working with a large number of files, the “By page” scrolling mode will shift the listing of files down or up one page at a time, when pressing the  or  keys, respectively. When the desired file appear, shift to the “By item” mode to select a particular file.

Menu Softkey



Press  to view the data file or press the Right Softkey labeled **Menu** for more options.



FIGURE 17-3 Data Explorer Menu

Highlight the desired function and press . To leave this menu without taking any action press the **Close** Softkey.

View

The View function opens a data view of the selected data file.

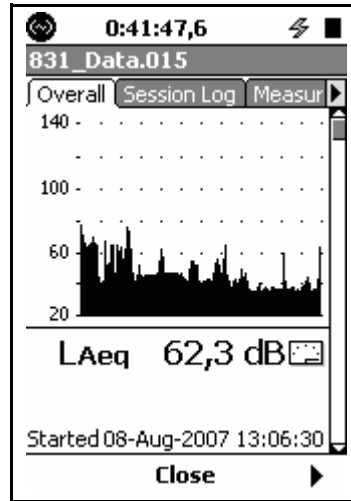

FIGURE 17-4 Data View

The information displayed is similar to the data described in the section ‘Overall Tab’ on page 5-12.

The file name of the data file being displayed is found in the title bar near the top of the screen.

For information on the **Session Log** tab see ‘Session Log Tab’ on page 5-25.

Press the Center Softkey labeled **Close** to return to the Data Explorer view.

Delete

The Delete menu item deletes the highlighted stored data file. The prompt shown in FIGURE 17-5 will be displayed.



FIGURE 17-5 Delete File

Highlight the appropriate response and press .

Delete All Internal

Note that the file number used for the file names will be reset to 001 when the Delete All Internal is performed.

The Delete All Internal menu item will delete all files saved to the internal memory of the Model 831. The prompt shown in FIGURE 17-6 will be displayed.

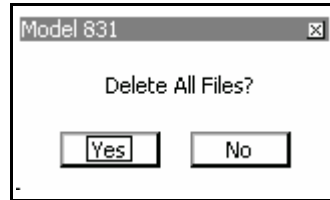

FIGURE 17-6 Delete All Files Prompt

Highlight the appropriate response and press **ENTER**.

Delete All USB

The Delete All USB menu item will delete all files saved on the USB device. The prompt shown in FIGURE 17-6 will be displayed; respond as appropriate.

Rename

The Rename menu item enables you to change the name of the selected data file. Pressing **ENTER** brings up a message box for editing the file name.

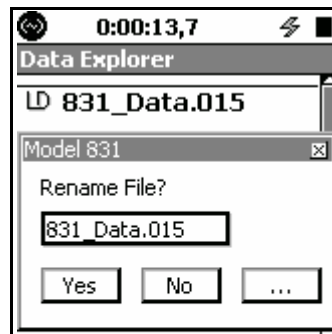

FIGURE 17-7 Rename File

Highlight the text box with the file name, press **ENTER**, modify the name as desired and press **ENTER** to complete the changes.

Highlight the **Yes** button to accept the changes or the **No** button to discard the changes and press **ENTER**.

If your new file name is the same as a file already in the directory, an Overwrite message box will appear. See

FIGURE 17-9. If you select **Yes**, then the old file will be over written with the newly named file. A response of **No** will return the Rename message box.

Another method of renaming a file is to Overwrite an old file. Highlight the “...” button and press **ENTER** to display a list of file names. This feature will allow you to select the name of an existing file and replace that file with the file you are renaming. See FIGURE 17-8.

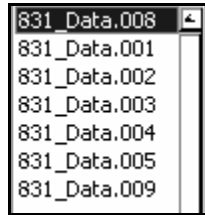

FIGURE 17-8 File Name List

Highlight a name from the list and press the **ENTER** key.

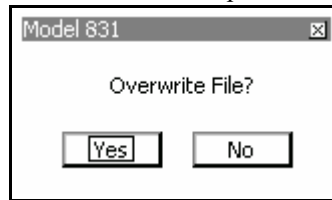
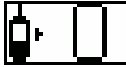

FIGURE 17-9 Overwrite Confirmation

A message box will appear requesting confirmation of the desired action. Select the desired response and press **ENTER**. If you select **Yes**, then the old file will be over written with the selected file. A response of **No** will return to the Rename message box.

Move to USB

The Move to USB menu item transfers a selected internal memory data file to a USB memory device. While the data is transferred, the following icon is displayed:



Note: The Move to USB feature does not copy the data file to a USB memory device--it moves it. Once the file is moved to the memory device, the data is not preserved on the 831.

When the data has been completely transferred, the message shown in FIGURE 17-10 is displayed.

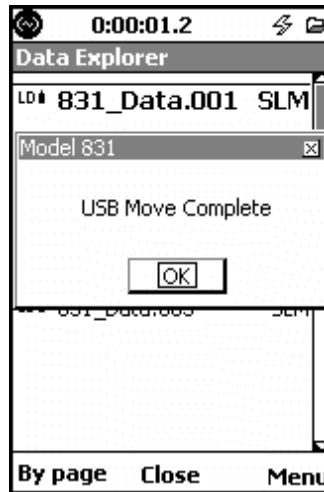

FIGURE 17-10 USB Move Complete Message

If a file with the same name already exists on the USB memory device when the move is initiated, the filename of the data being transferred is altered by pre-pending it with the letter “a.” The message shown in FIGURE 17-11 is then displayed.

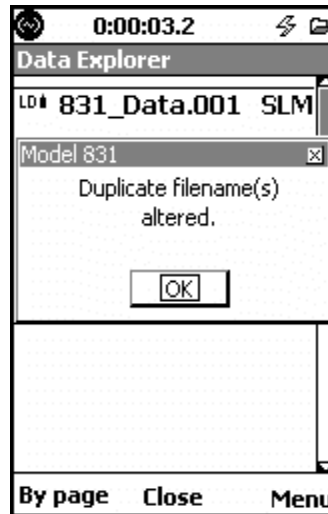

FIGURE 17-11 Duplicate Filename Altered

If the file size is larger than the available free space on the USB drive, the file is not moved and the message shown in Figure 17-12 appears.



FIGURE 17-12 Insufficient Space on USB Drive Message

Move All to USB

The Move All to USB menu item transfers all files on the internal flash memory to the USB memory device. The procedure is similar to that described in "Move to USB" on page 17-7.

If the attached USB Flash Drive (or mass storage device) already has a file named the same as one being moved from internal memory, the instrument automatically alters the name so that it will be unique.

For standard files that are named with the user selected default filename and a three digit sequential number extension (831_Data.001), the first number in the extension will be changed to a letter, from "A" through "Z", that offers a unique filename and will then be saved to the USB Flash Drive. The filename on the internal drive will not be altered.

For auto-store files (one whose name is made from the date of measurement, i.e. 08010700.LD0) the digit of the extension will be incremented from 0 through 9 (i.e. LD0, LD1, and so on to LD9). If this method does not succeed in creating a unique filename then the extension will be changed to "A00" and the "A" will be changed, if needed, up through "Z" until a unique filename is found.

If a unique filename cannot be determined by these methods then the file will not be copied to the USB Flash Drive, but will remain on the internal drive:

Example 1

The USB Flash Drive has been used as a transport for data and currently contains files named 831_Data.001, 831_Data.002 and 831_Data.003. Perhaps I forgot to erase the drive, but more likely I just like to keep an extra copy of the data as a backup. The data inside the instrument was reset and deleted with the Delete All Internal command from Data Explorer so that new data files were named the same as previously (starting the sequence number over at 001). More data has been taken and the internal drive has two files named 831_Data.001 and 831_Data.002. When you perform a Move all to USB from the Data Explorer memory the filename conflict will be detected and the names of the files that will actually be stored to the USB Flash Drive will be named 831_Data.A01 and 831_Data.A02. If I did this again the new files would be named 831_Data.B01 and 831_Data.B02.

Example 2

The USB Flash Drive is being used to transport data from three instruments used as remote noise monitors that automatically do daily auto-stores. There are data for one week on each instrument for a total of seven files each. All seven files are moved to the USB Flash Drive from the first instrument, 08010700.LD0 through 08011300.LD0. At the second instrument, that has seven files with the exact names,

a Move All to USB is performed. This time the files stored to the USB Flash Drive have a name conflict and will actually be stored as 08010700.LD1 through 08011300.LD1. At the third location we do the same thing and now the USB Flash Drive has 08010700.LD2 through 08011300.LD2 added to it.

Refresh List

The Refresh List menu item will refresh the file list on the Data Explorer Page.

Load Settings

Using the Load Settings Menu item, a new measurement may be run with the exact same parameters as the selected measurement. When  is pressed, the parameters from the selected measurement are loaded so a new measurement may be made. This is a convenient method to duplicate a previous measurement.

Jump to Beginning

The Jump to Beginning menu item will select the first data file listed.

Jump to End

The Jump to End menu item will select the last data file listed.

System Properties

The System Properties tabs are used to identify and / or control functions of the Model 831 that are not related to sound measurement or calculations.

Control Panel - System Properties



To activate the **System Properties** tabs, press the  (TOOLS) key. Highlight the **System Properties** icon as shown in FIGURE 18-1 "Control Panel" .



FIGURE 18-1 Control Panel

Press the  (ENTER) key to open the **System Properties** tabs.

You can scroll through **System Properties** tabs by using the Right and Left Softkeys. All **System Properties** tabs have only one page.

Device

The **Device** tab has three fields in that the user may enter information about the instrument. This can identify the owners company name and address. Information may be easily placed in these fields using G4 LD Utility.

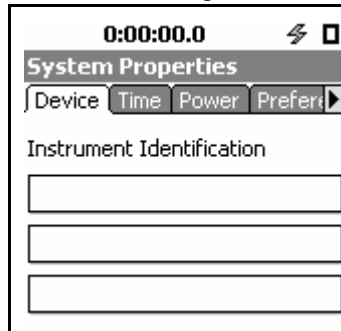

FIGURE 18-2 Device Tab

Highlight one of the three fields to edit. Enter the desired text and press **ENTER** to accept the information and move the highlight out of the field. At this point another field can be selected and the above process repeated.

Time

The time and date for the Model 831 may be adjusted on the **Time** tab.

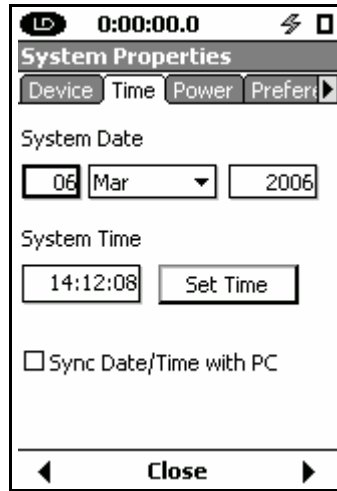





FIGURE 18-3 Time Tab

Setting Day and Year

Highlight the data field for the day or year and press  or  to specify the numeric value. Press  to select the value.

Selecting the Month

Highlight the Month data field and press  to drop down a list of months, as shown in FIGURE 18-4.



FIGURE 18-4 Month List

Highlight the desired month and press **ENTER** to accept the selection and exit the field.

Setting the Time

Highlight the System Time data field and press **←** or **→** to specify the desired time.

Sync Date/Time with PC

Selecting the “Sync Date/Time with PC” check box enables the Model 831 time to be set to the PC time when the unit is connected to G4 LD Utility. Highlight the box and press **ENTER** to either enable or disable this option.

Setting the Clock

Note: When setting the date and time, allow a two second pause before beginning a measurement. This allows the Model 831 clocks to synchronize.

Highlight the **Set Time** button and press **ENTER** to activate the **System Date** and **System Time**. The new settings for the Model 831 clock take effect immediately upon pressing **ENTER**. Figure 18-18-5 shows the message confirming the activation of the new settings.



FIGURE 18-5 Confirmation of New Settings

Power

The default values for these parameters are shown in FIGURE 18-6.

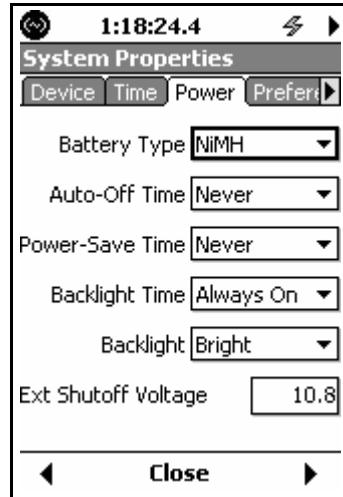

FIGURE 18-6 Power Tab

There are five drop down list fields and one scrollable value field on the **Power** tab. These fields are selected and modified as discussed in the previous sections.

Battery Type

This parameter identifies the type of battery installed in the Model 831. This information is used for the calculation of battery life.

To set the battery type, highlight the Battery Type data field and press **ENTER** to open the Battery Type Menu, shown in FIGURE 18-7.

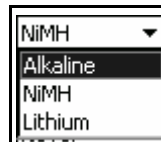

FIGURE 18-7 Battery Type Menu

Highlight the desired time and press **ENTER** to make a selection. Battery type must be set to NiMH to charge.

The default value is “Alkaline”.

WARNING: Do not mix Alkaline and NiMH batteries.

WARNING: Do not mix batteries from different manufacturers

WARNING: Replace all four batteries when installing fresh cells

WARNING: The correct battery type must be specified, as described in "Battery Type" on page 18-5, based on the battery type installed. Otherwise, serious damage, injury or fire can occur when the battery type is set to NiMH but Alkaline or Lithium batteries are installed because the internal charger will be enabled. Alkaline or Lithium batteries must not be charged.

Auto-Off Time

Auto-Off time is the duration of time the instrument will stay on when no activity is occurring: button presses, running a measurement, USB communications, etc.

Pressing the  (ON / OFF) key will return the instrument and the display to the state it was in when the Auto-Off time expired.

The auto-off feature is ignored when connected to external power (assumed to mean when not on internal batteries which includes USB and External Power). When the unit is connected to USB power, the feature is ignored but when it is connect to external power (12 Vdc) it is not ignored.

To set the Auto-off Time, highlight the Auto-Off Time data field and press  to open the Auto-Off Time Menu, shown in FIGURE 18-8.

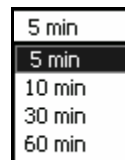



FIGURE 18-8 Auto-Off Time Menu

Highlight the desired time and press  to make a selection.

The default value is “Never”.

Power-Save Time

In the power save mode, battery power is significantly reduced by shutting down the display and analog circuitry and ceasing signal processing activities.

There are two power saving features controlled by the Power-Save Time setting. Power can be shut off to the display and to the analog circuitry to save power when the Power-Save Time is set to a value other than **Never**.

The display will be powered down when no keys on the instrument have been pressed for the time set. Pressing any key will reactivate the display.

The analog circuitry, including power to the preamplifier, will be shut down when the instrument has been stopped for the time set. Pressing the  (RUN / PAUSE) key will restore power to the analog circuitry and the instrument can take data in a number of seconds.



To set the Power-Save Time, highlight the Power-Save Time data field on the **Power** tab and press  to open the Power-Save Time Menu, shown in FIGURE 18-9.



FIGURE 18-9 Power-Save Time Menu

Highlight the desired time and press  to make a selection.

The default value is “Never”.

Power Save Icon



When the Model 831 is in the power save mode, the power save icon



will be displayed in the location where the measurement status icons, described in "Measurement Status" on page 3-10, usually appear.

Exit from Power Save Mode

Press any of the following keys to exit from the power save mode:

-  (STOP/STORE)
-  (RESET)
-  (RUN/PAUSE): There will be a few seconds delay before the instrument starts recording data.

The following actions will also cause an exit from the power save mode:

- Calibrate
- Record (voice or sound recording)
- Play (voice or sound recording)

Backlight Time

This sets the duration of time the backlight remains on after the last key press.

To set the Backlight Time, highlight the Backlight Time data field and press  to open the Backlight Time Menu, shown in FIGURE 18-10.

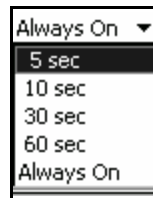



FIGURE 18-10 Backlight Time Menu

Highlight the desired time and press  to make a selection. The default is “10 sec”.

Backlight

Using the backlight on bright setting will significantly increase power consumption and decrease battery life

This field sets the intensity of the backlight. To set Backlight, highlight the Backlight data field and press **ENTER** to open the Backlight Menu, shown in FIGURE 18-10.

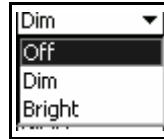

FIGURE 18-11 Backlight Menu

Highlight the desired time and press **ENTER** to make a selection. The default is Off.

Exceptions

There are several situations which will affect the backlight and its intensity as follows:

- When the USB Host port is turned On, the backlight will be turned Off for five seconds
- When the USB Host port is On, the backlight will not go into the Bright intensity (if set to Bright, it will switch to the Dim intensity)
- When running on battery power, if the batteries are less than 10% the backlight will not go into the Bright intensity (if set to Bright, it will switch to the Dim intensity)
- When running on battery power, if the batteries are less than 3%. the backlight will not be permitted to turn on.

Display Contrast

You can adjust the contrast of the display to accommodate varying viewing angles, temperature and lighting condition. Adjustment ranges from - 9 to +9. The default is 0.

To set the Display Contrast, press the **⏏** key from any data viewing tab. Highlight the Display Contrast data field and press **ENTER**. This will open a single digit data field as shown in Figure 18-18-12.



FIGURE 18-12 Entering Display Contrast

Enter a value in the range 0 to 9 and press **ENTER** to apply the setting.

External Shutoff Voltage

To avoid damaging the internal batteries when the voltage of an external battery drops too low, the user can set an external shutoff voltage. The instrument will shut off automatically when the external voltage drops below this level.

The default level is 10.8 volts, but the user can select a value in the range 10 to 25 volts by entering the value directly into the Ext Shutoff Voltage field shown in FIGURE 18-13.

Ext Shutoff Voltage	10.8
---------------------	------

FIGURE 18-13 External Shutoff Voltage Menu

Preferences

FIGURE 18-14 shows the default values for the parameters on the **Preferences** tab.

The **Preferences** tab is used to configure various instrument functions.

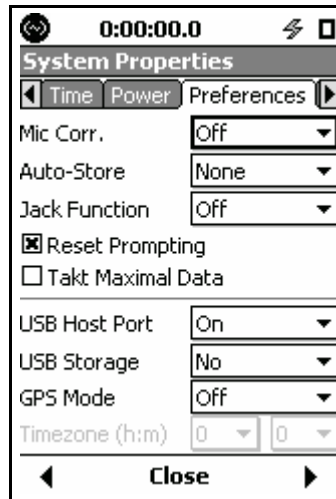

The screenshot shows the 'System Properties' dialog box with the 'Preferences' tab selected. The settings are as follows:

Mic Corr.	Off
Auto-Store	None
Jack Function	Off
<input checked="" type="checkbox"/> Reset Prompting	
<input type="checkbox"/> Takt Maximal Data	
USB Host Port	On
USB Storage	No
GPS Mode	Off
Timezone (h:m)	0 0

FIGURE 18-14 Preferences Tab

Select the desired preference and press **ENTER** to view a list of options.

Microphone Correction

When using a free-field microphone, a correction can be applied to provide a random incidence response or, when using a random incidence microphone, a correction can be applied to provide a free-field response. Highlight the **Mic Corr.** field and press **ENTER** to open the Microphone Correction menu shown in FIGURE 18-15.

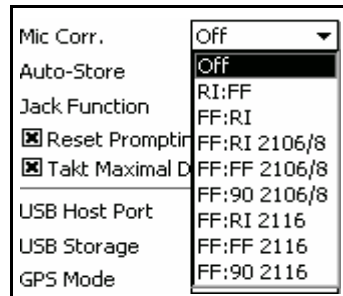

FIGURE 18-15 Microphone Correction Menu

To correct a random incidence microphone to obtain a free-field response, highlight **RI -> FF** and press **ENTER**.

To correct a free-field microphone to obtain a random incidence response, highlight **FF -> RI** and press **ENTER**.

The default mode is **Off**.

Auto-Store

The Model 831 provides three Auto-Store options to enhance your data gathering activities:

*When using Auto-Store, data files are stored in the following format, regardless of what is specified in the **General** setup tab: **yymmdd00.LD0**, where **yymmdd** is the date the measurement was started.*

- None
- Prompt
- Store

Select the Auto-Store field and press **ENTER** to obtain a listing of the choices, as shown in FIGURE 18-16.



FIGURE 18-16 Auto-Store Preferences

Select the desired Auto-Store option and press  to make the selection.

None

The user must press the  key to Stop the measurement. Press it again to store the data and also assign a filename. See ‘Storing the Measurement’ on page 7-15.

Prompt

*If the **Prompt** preference is selected and the run mode is set to **Timed Stop** or **Daily Timer**, pressing the  key before the stop time has elapsed will not result in a prompt to save, nor will the data automatically be saved.*

When the stop time has elapsed, the user will be prompted to save the data file. See ‘Storing the Measurement’ on page 7-15. If the user responds **Yes**, then a data file is saved. If **No** is selected, a data file is not saved. If data was stored when the  key is pressed, the instrument is automatically reset so a new measurement may begin.

Store

*If the **Store** preference is selected and the run mode is set to **Timed Stop** or **Daily Timer**, pressing the  key before the stop time has elapsed will not result in the data being automatically stored.*

When the stop time has elapsed, the data file is automatically saved. The default file name is assigned to the file. There is no user interaction in this process.

By pressing the  key, the instrument will automatically reset so a new measurement may begin.

The following table shows how manual or timer-based stops affect Auto-Store preferences in various run modes.

Run Mode	Type of Stop	Auto-Store Preference	
		Prompt	Store
Timed Stop	Timer-activated final stop	Prompts when timer is complete	File automatically stored
	Manually-activated (stop key)	No action performed	No action performed
Stop When Stable	Timer-activated stop	Prompts when stable	File automatically stored
	Manually-activated (stop key)	Prompts when stopped	File automatically stored
Single Block Timer	Timer-activated stop	Prompts when timer complete	File automatically stored
	Manually-activated (stop key)	Prompts when stopped	File automatically stored
Daily Timer	Timer-activated final stop	No prompt; file automatically stored	File automatically stored
	Manually-activated (stop key)	No action performed	No action performed

Table 18 - 1 Run Mode Behavior

Jack Function

The AC/DC Out/Headset Jack on the bottom of the instrument can be configured to provide one of the following:

- As an AC/DC output of the signal from the detector. Use with the optional AC/DC Output Cable (CBL139). The AC output is typically directed to a frequency analyzer or oscilloscope and the DC output is typically directed to a strip chart recorder.
- As a microphone and speaker connection when used with the optional headset for voice recording/playback (ACC003)

It can also be set to **Off**.

The jack function setting becomes active as soon as it is selected.





Use the  and  keys to highlight the Jack Function field and press  to obtain a listing of the choices as shown in FIGURE 18-17.



FIGURE 18-17 Jack Function Preferences

Highlight the desired Jack Function press  to make the selection.

Reset Prompting

If the Reset Prompting check box is checked, the user will be prompted with an “Are You Sure” message box whenever the  (RESET) key is pressed. If it is not checked, this prompt will not appear prior to the reset action taking place.

Highlight the Reset Prompting check box. Pressing  toggles the state of the check box.

Takt Maximal Data

The definition of LAFTM5 is shown in "Taktmaximal-5" on page D-21.

When this is checked, the parameter LAFTM5 is also measured and displayed on the **Overall** and **Current** tabs and as a parameter of a Time History measurement.

USB Host Port

Note that this must be On in order to utilize the USB Port with peripheral devices.

This function controls the power to the USB Port, so it must be set to On in order to utilize it with peripheral devices. Highlight the USB Host Port field and press  to obtain a listing of the choices as shown in FIGURE 18-17.

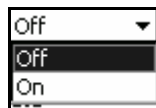



FIGURE 18-18 USB Host Port On/Off Menu

Highlight the desired USB Host Port Status and press  to make the selection. When the USB Host Port is set On,

additional data fields associated with the use of the USB Host port will appear as shown in

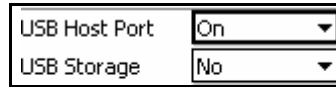

FIGURE 18-19 USB Host Port Parameters

USB Storage

Data might not be copied correctly if the USB drive has not been properly formatted. As a result, it is recommended that the drive be formatted before using it.

Data can be stored to internal memory or to an external memory device connected to the USB Port. The options are:

- **No:** Store only to internal memory
- **Auto:** Store data to USB memory if available; otherwise, store to internal memory.

Highlight the USB Storage field and press **ENTER** to obtain a listing of the choices as shown in FIGURE 18-17.

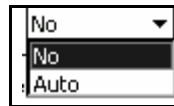

FIGURE 18-20 USB Storage Preferences

Highlight the desired USB Storage and press **ENTER** to make the selection.

When data is stored to USB memory, it is first stored to internal flash memory, a process which is much more rapid than storing directly to USB memory. Following that, the data is then copied to USB memory without interfering with the operation of the instrument. When the data file has been successfully copied, the original data file in internal memory is deleted.

USB Serial Printer (PRN003)

It is possible to print an Overall Summary and a screenshot of the Model 831 screen using a USB Serial Printer (MCP8770). To do this, plug the USB printer into the USB port and turn it on. Then, turn on the USB Port as described in ‘USB Host Port’ on page 18-14. This will add two items to the Menu display, as shown in FIGURE 18-21 and FIGURE 18-22.

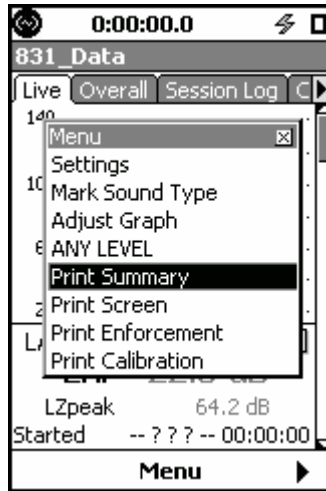

FIGURE 18-21 Print Summary Menu Item

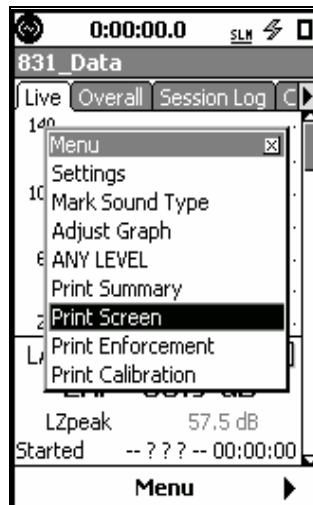

FIGURE 18-22 Print Screen Menu Item

Highlighting either one and pressing **ENTER** will initiate the corresponding print. When the print has been successfully completed, the message shown in FIGURE 18-23 will appear to confirm this.



FIGURE 18-23 Print Complete Message

Print Error Messages

If the user tries to print without connecting the printer or with printer powered off, the message shown in FIGURE 18-24 will appear informing the user that the printer is not present.



FIGURE 18-24 Printer Not Present Message

If the printer is disconnected during the printing process, the message shown in FIGURE 18-25 will appear.



FIGURE 18-25 Printer Disconnected Message

GPS Mode

The USB Host Port must be set to On for the GPS Mode field to appear. Note that the daylight saving time is not supported.

Highlight the GPS Mode field and press **ENTER** to obtain a listing of the choices as shown in FIGURE 18-26.

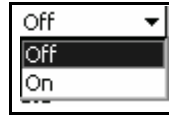

FIGURE 18-26 GPS Mode On/Off Menu

Highlight On and press **ENTER** to make the selection.

When using the SLM Utility-G3 software to control the Model 831, there are two operational modes for the GPS:

GPS On

In this mode, the GPS is always on and consuming power, but the **GPS** tab is also always being updated. This can be useful for real-time tracking of location or time.

GPS Auto

In this mode, the GPS will turn on at two different time:

- At the beginning of an interval, the GPS will turn on to record the location
- During a daily autostore, the GPS will turn on to check the time and update the internal clock if needed

Time Zone

Setting the GPS to On will open the menus to select the time zone in which the GPS is located, as shown in FIGURE 18-27

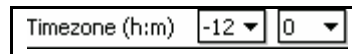

FIGURE 18-27 GPS Time Zone Menu

The time zone is selected by both hours (1st data field) and minutes (2nd data field), referenced to Greenwich Mean Time. Highlight the desired data field, and press **ENTER** to list the options, as shown below. Highlight the desired value and press **ENTER** to make a selection.

Hours

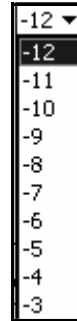

FIGURE 18-28 Time Zone: Hours

The Time Zone Hours range from -12 to +13, in integer steps.

Minutes

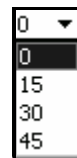

FIGURE 18-29 Time Zone: Minutes

The available values range from 0 to 45, in 15 minute steps.

Localization

Note that the default values for these parameters are as shown in FIGURE 18-30.

The **Localization** tab, shown in is used to select formats for parameters which may vary from one country or region to another. FIGURE 18-30.

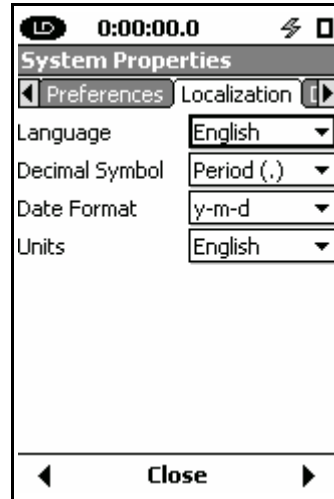

FIGURE 18-30 Localization Tab

Highlight the parameter to be set and press **ENTER** to view a list of options.

Languages

The Model 831 supports the following languages:

- English
- Czech
- French
- German
- Italian
- Portuguese(pt)
- Spanish
- Swedish
- Norwegian

- Portuguese(br)

English is the default language.

Highlight the Language field and press **ENTER** to obtain a listing of the language choices as shown in FIGURE 18-31.



FIGURE 18-31 Language Preferences

Highlight the desired language and press **ENTER** to make a selection.

Decimal Symbol

The Model 831 supports two formats for the decimal symbol

- Period (.)
- Comma (,)

Highlight the Decimal Symbol field and press **ENTER** to obtain a listing of the choices as shown FIGURE 18-32.

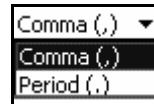

FIGURE 18-32 Decimal Symbol Preferences

Highlight the desired symbol and press **ENTER** to make the selection.

Date Format

The Model 831 supports two formats for expressing dates

- day-month-year
- year-month-day

Highlight the Date Format field and press **ENTER** to obtain a listing of the choices as shown in FIGURE 18-33.

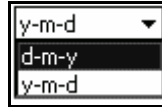

FIGURE 18-33 Date Format Preferences

Highlight the desired Date Format and press **ENTER** to make the selection.

Units

The Model 831 supports both English and SI units.

Highlight the Units field and press **ENTER** to display the Units Menu as shown in FIGURE 18-34.

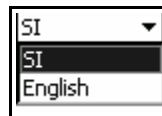

FIGURE 18-34 Units Menu

Highlight the desired Units and press **ENTER** to make the selection.

Displays

Note that the default values for these parameters are as shown in FIGURE 18-35.

The **Displays** tab, shown in FIGURE 18-35., permits some customization of the displays

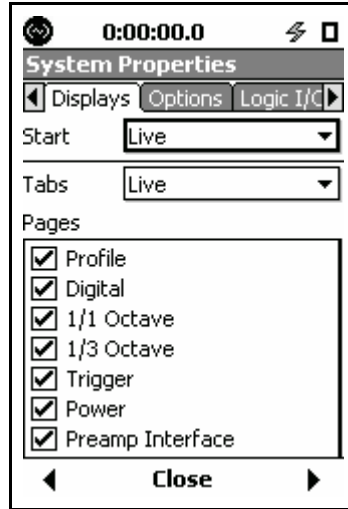

FIGURE 18-35 Displays Tab

Start

The user can select to have one of the following displays appear when the Model 831 is switched **On**.

With the Start data field highlighted, press **ENTER** to obtain a list of options, as shown in FIGURE 18-36.

Note that this list will present only those measurements which have been enabled in the setup.



FIGURE 18-36 Display Start Options

Highlight the Display Start option and press **ENTER** to make the selection.

Selecting Displays to Appear

When there are measurement functions not being used or data displays which are not of interest for a measurement, the instrument operation can be streamlined by hiding selected displays. As a default, all available displays are set to appear.

Tab Selection

The displays to be used are selected one tab at a time. Highlight the tabs field to list the tabs for which displays can be set to appear or be hidden, as shown in FIGURE 18-37.



FIGURE 18-37 Displays Tab Options

Highlight the desired tab and press **ENTER** to make the selection.

Display Selection

The displays that can be set to appear or to be hidden are shown below for each of the possible tab selections.

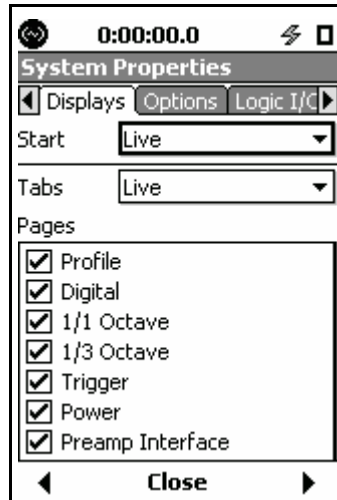

FIGURE 18-38 Live Tab Displays

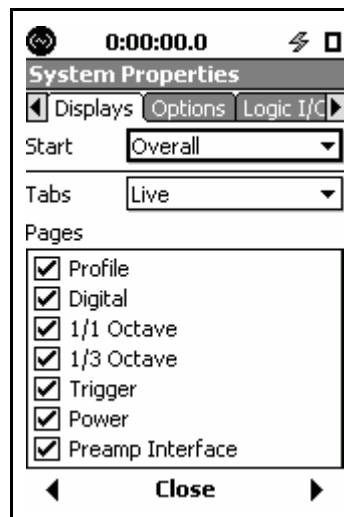
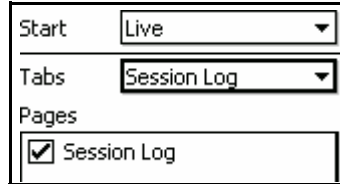

FIGURE 18-39 Overall Tab Displays

Session Log Display



The screenshot shows a control panel for the Session Log Display. It features three main sections: 'Start', 'Tabs', and 'Pages'. The 'Start' section has a dropdown menu with 'Live' selected. The 'Tabs' section has a dropdown menu with 'Session Log' selected. The 'Pages' section contains a list of items, with 'Session Log' checked and highlighted.

Start	Live
Tabs	Session Log
Pages	<input checked="" type="checkbox"/> Session Log

FIGURE 18-40 Session Log Displays

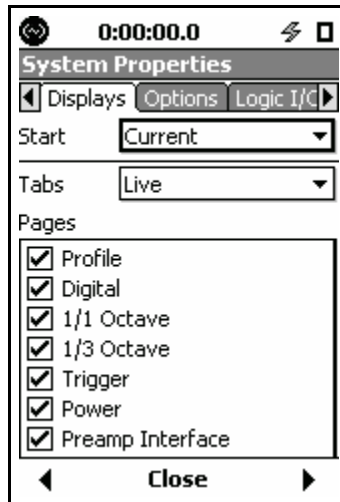

The screenshot shows a control panel for the Current Displays. At the top, there is a status bar with a signal strength icon, a timer showing '0:00:00.0', and a power icon. Below this is a title bar 'System Properties' with three tabs: 'Displays', 'Options', and 'Logic I/C'. The 'Displays' tab is active. The panel includes 'Start' (dropdown: 'Current'), 'Tabs' (dropdown: 'Live'), and 'Pages' (checkbox list). The 'Pages' list includes: Profile, Digital, 1/1 Octave, 1/3 Octave, Trigger, Power, and Preamp Interface, all of which are checked. A 'Close' button is located at the bottom center.

Start	Current
Tabs	Live
Pages	<input checked="" type="checkbox"/> Profile <input checked="" type="checkbox"/> Digital <input checked="" type="checkbox"/> 1/1 Octave <input checked="" type="checkbox"/> 1/3 Octave <input checked="" type="checkbox"/> Trigger <input checked="" type="checkbox"/> Power <input checked="" type="checkbox"/> Preamp Interface

FIGURE 18-41 Current Displays

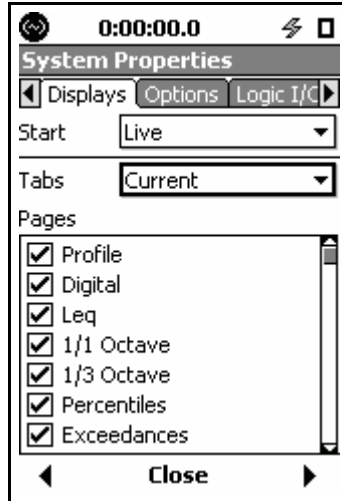

FIGURE 18-42 Measurement Displays



FIGURE 18-43 Events Displays



FIGURE 18-44 Time History Displays

All displays which have a check in their check box will appear on the Model 831.

To modify any of the displays associated with one of the tabs, highlight the field listing those displays and press **ENTER** to obtain a display similar to FIGURE 18-45, where the first item is highlighted.

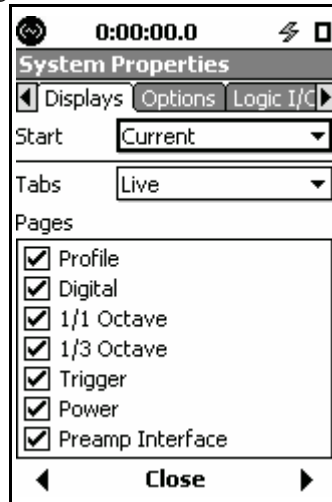

FIGURE 18-45 Display; Set to Appear or Hide

Pressing the \odot key will toggle the state of the highlighted display between **Appear** (checked) and **Hide** (unchecked).

Highlight different displays and set them as desired. When finished setting the display types for this tab, press ENTER .

When all desired modifications have been made to the displays for all tabs, press the center softkey **Close** to return to the Control Panel.

Options

Note that default options, Community Noise for example, will not appear in the list as they cannot be masked. Also, RT-60, Exceedances, 1/1 Octave, and 1/3 Octave cannot be masked while in RT-60 mode.

The **Options** tab permits the user to enable/disable installed options on the Model 831.

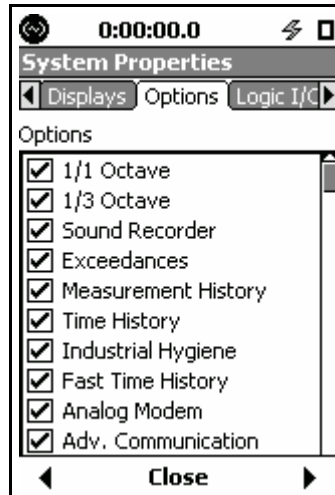

FIGURE 18-46 Options Tab

Note that this is temporary and does not result in permanent loss of a purchased option. The user is able to re-enable a purchased option at any time and a restore/format defaults will also enable all purchased options.

When the option is checked in mask, it is enabled in the instrument. Unchecking removes the option. To mask or unmask any option(s), press ENTER to enter the dialog mode. Use the \leftarrow and \rightarrow arrow keys to highlight each option and use the \odot and ENTER arrow keys to toggle the state of the option between masked (unchecked) and unmasked

(checked). In Figure 18-18-47, we see that the Sound Recorder option has been masked.

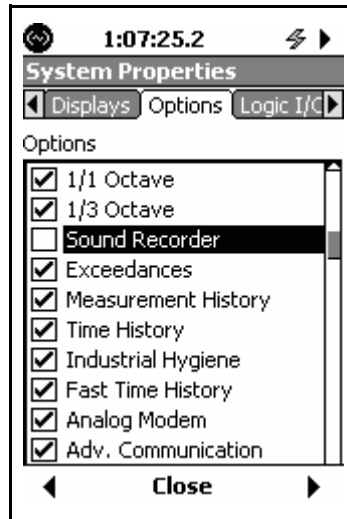

FIGURE 18-47 Sound Recorder Masked

When all selections have been made, press **ENTER** to exit the dialog mode and press **Close**, which will produce the message shown in FIGURE 18-48

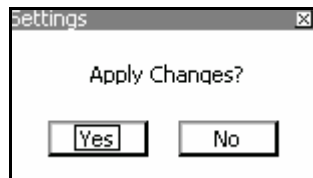



FIGURE 18-48 Apply Changes

Highlight Yes and press **ENTER**, which will produce the message shown in FIGURE 18-49 indicating that the instrument must be rebooted for the masking/unmasking changes to take effect.



FIGURE 18-49 Reminder to Reboot Instrument

Press the  key to return to the System Properties Menu and reboot the instrument.

Logic I/O

The Model 831 has one logic in line and one logic out line. The role of these lines is defined in the Logic I/O menu, shown in FIGURE 18-50.

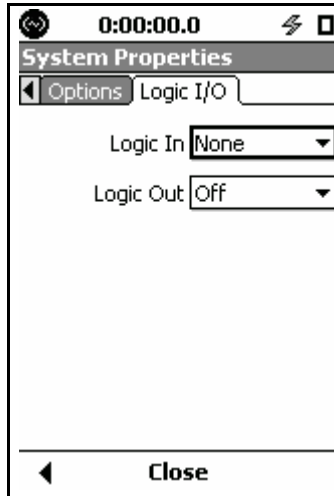

FIGURE 18-50 Logic I/O Menu

The Logic In line receives a signal from an external device such as the 831-INT, permitting it to initiate one of the actions listed in FIGURE 18-51.

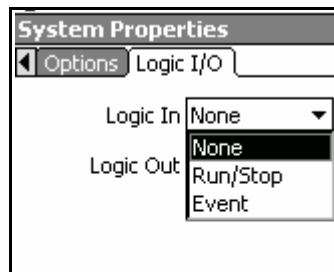

FIGURE 18-51 Logic In Menu

Logic Out

The Logic Out line transmits a signal to an external device such as the 831-INT, defining one of the states listed in FIGURE 18-52.

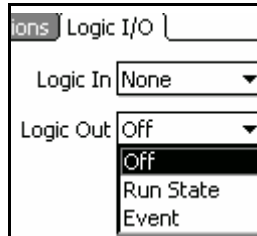

FIGURE 18-52 Logic Out Menu

Run State

When the Logic Out is set to Run State, then the output will be driven high when the Model 831 is running and will be driven low when the Model 831 is stopped.

Event

When the Logic Out is set to Event, then the output is dependent upon the event trigger settings as follows:

Level Triggering

If the event mode is set to Level Triggering, then this output will be driven high whenever the current RMS level exceeds the SPL1 trigger level or the current Peak level exceeds the Peak1 trigger level. If the current RMS level is below SPL1 and the current peak level is below Peak1, then the output will be driven low.

Dynamic

If the event trigger is set to Dynamic, then the output will be driven high when the current SPL level exceeds the dynamic trigger level plus the dynamic trigger offset and will be driven low when the current SPL level is below the dynamic trigger level plus the dynamic trigger offset.

Non-Acoustical Inputs

This chapter discusses the use of external transducers and devices to provide non-acoustical data to the Model 831. Included are the following:

- **831-INT Interface Unit**
- **Weather (Wind, Temperature and Humidity)**
- **Location using GPS device**

831-INT

For a detailed description of the design and use of the 831-INT, see the Larson Davis manual 831-INT.01.



FIGURE 19-1 831-INT with Model 831 Mounted

The 831-INT is a device that connects to the Model 831 through the 831's I/O connector and enhances the capabilities of the 831 to include interfaces for all necessary components of a permanent noise monitoring system. These components include the following:

- **Weather Sensors:** Wind Speed, Wind Direction, Temperature, Humidity
- **Backup Battery Management and Charging Control**
- **Power Management:** including switch over to battery power when mains power fails and support for solar panels

- 4-port Powered USB Hub
- 2 Digital I/O lines: 1 in, 1 out

Weather Measurement Using 831-INT

Note that the optional firmware 831-WTHR must be enabled in order to measure weather parameters with the Model 831.

Larson Davis Sensors

The following devices are available from Larson Davis for the measurement of weather data:

The SEN028, SEN029, and SEN030 products are no longer supported.

- **SEN028 Wind Monitor: Wind Speed and Direction**
- **SEN029 Anemometer (Low Cost): Wind Speed and Direction**
- **SEN030 Sensor: Temperature and Humidity**

These sensors connect to the Model 831 via the 831-INT.

Setup

The parameters controlling the measurement of weather data are setup from the **Weather** tab shown in FIGURE 19-2.

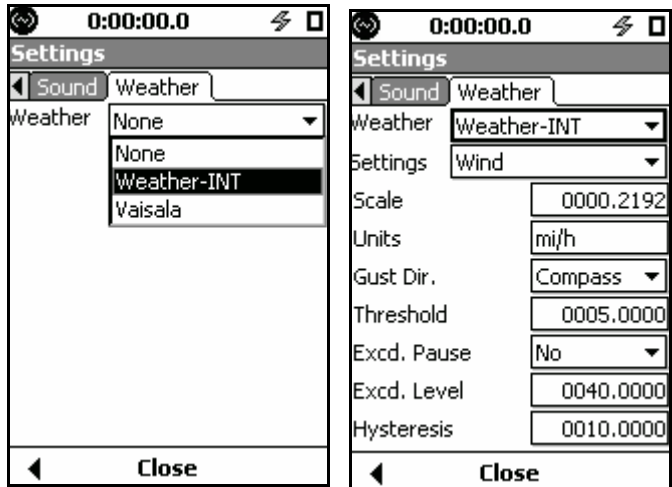

FIGURE 19-2 Weather-INT Setup

The settings menu, shown in FIGURE 19-2, is used to select which weather parameters are to be setup.

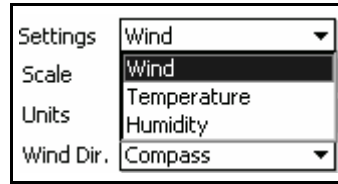

FIGURE 19-3 Weather Settings Menu

Wind Setup

The Wind Setup menu is shown in FIGURE 19-2. Most of the parameters call for direct input of numeric values based on the design parameters of the wind transducer or text based on the preference of the user.

The scale setting allows the use of any pulse type of anemometer and permits the scaling to any wind speed metric. The Model 831 measures the frequency of the wind speed (or tachometer) signal. The displayed value is the measured frequency (Hz) multiplied by the calculated scale factor of the sensor. Below is a table showing the scale values to enter into the Model 831 for the SEN028 and SEN029 for various units of measure. The **Units** is the text label to enter into the Units field of the Model 831.

Units of Measure (abbreviation)	SEN028 Scale RM Young Wind Monitor	SEN029 Scale Davis Anemometer	Units label
Meters per second (m/s)	0.0980	1.0064	m/s
Kilometers per hour (km/h)	0.3528	3.6230	km/h
Miles per hour (mi/h)	0.2191	2.2500	mi/h

Table 19-1 Wind Sensor Scale Factor

Knots (kn)	0.1904	1.9553	knots
Feet per second (fps)	0.3216	3.3026	fps

Table 19-1 Wind Sensor Scale Factor

Compass

The compass menu, shown in FIGURE 19-4, provides a list of permitted formats.

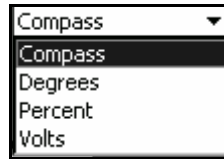

FIGURE 19-4 Weather Compass Menu

Temperature Setup

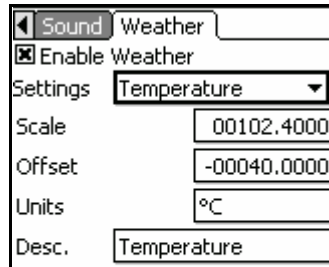

FIGURE 19-5 Weather Temperature Menu

Humidity Setup

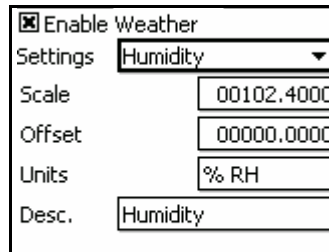

FIGURE 19-6 Weather Humidity Menu

Vaisala Weather Station

Units

Units are not configurable using the Vaisala Weather Station (SEN-031). However, they will follow English or SI units as configured in the System Properties dialog described in Chapter 18.

	English	SI
Wind	mi/h	m/s
Temperature	°F	°C
Relative Humidity	% RH	% RH

Table 19-2 Vaisala Units

Wind Setup

The Wind Setup menu is shown in FIGURE 19-7.

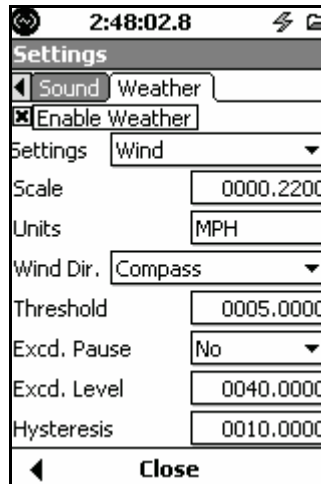

FIGURE 19-7 Weather Wind Menu

Wind Dir: Choose Compass or Degrees for the display (i.e., ENE vs. 70.0°)

Threshold: If the wind speed is above this threshold, it is considered windy.

Excd. Pause: If set to "Yes" and wind speed exceeds Excd. Level, sound exceedance are held off.

Excd. Level: if Excd. Pause is set to "Yes" and wind speed exceeds this level, sound exceedance are held off.

Hysteresis: If sound exceedance are paused due to a wind exceedance, wind speed must drop below (Excd. Level - Hysteresis) before sound exceedance are resumed.

Temperature Setup

Note: This menu is informational only.

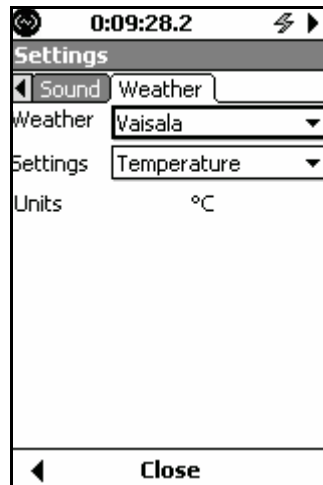

FIGURE 19-8 Weather Temperature Menu

Heater Setup

The Vaisala Heater setup is shown in FIGURE 19-9.

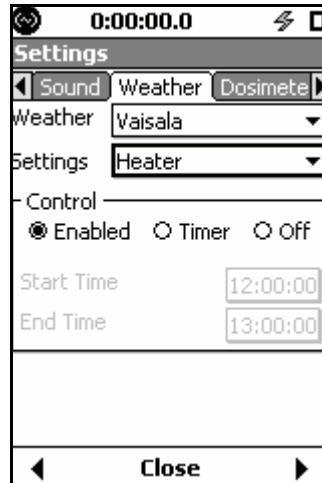

FIGURE 19-9 Heater Setup

For more information on Vaisala Heater settings, see the Vaisala Heater manual.

The Control settings are as follows:

- **Enabled** (shown above): the heater turns on or off automatically depending on the ambient temperature. The **Start Time** and **End Time** are dimmed.
- **Timer**: Makes the **Start Time** and **End Time** available for turning the heater on or off, respectively. Times are shown in 24-hour notation.
- **Off**: Keeps the heater always off. The **Start Time** and **End Time** are dimmed.

Humidity Setup

Note: This menu is informational only.

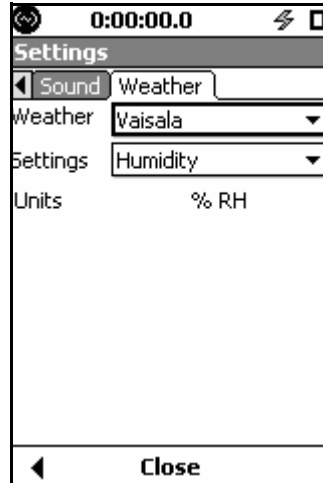

FIGURE 19-10 Weather Humidity Menu

When used with a Model 831, with the exception of precipitation data, the Vaisala weather station is configured to report measurements once per second. The reported values are the average over that one second interval. Wind Gust is the max speed detected over that interval.

The Vaisala will send precipitation information every 10 seconds if precipitation has been detected.

If the Model 831 is configured to include Vaisala weather data in the Time History, it will be this one-second data, even if the Time History period is set to something other than one second. This means that if the TH interval is less than one second, you will see a repetition of values until it is updated by the Vaisala. Conversely, if the TH interval is greater than one second, the reported value will be the average over the last second only.

Precipitation data is not available in the Time History.

Display

When weather has been enabled, the measured data will appear on both the **Live** and the **Overall** tabs.

Live Display

Instantaneous weather data appears on the **Live** tab shown in FIGURE 19-11.

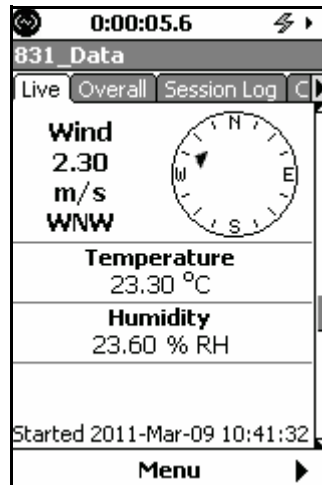

FIGURE 19-11 Live Weather Display

Average Weather

Average weather data appears on the **Overall** tab shown in FIGURE 19-12.

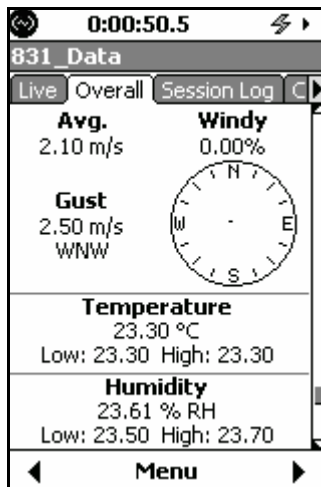

FIGURE 19-12 Overall Weather Display

Location Measurement Using 831-INT

The optional firmware 831-GPS must be enabled in order to utilize a GPS with the Model 831. Note that daylight savings time is not supported.

To provide global positioning information to the Model 831, Larson Davis offers the GPS001 USB GPS Receiver with a magnetic mount. This device is connected directly to the USB port of the Model 831,

Setup

The GPS Mode field will only appear when the USB Host Port is set to On.

The setup parameters for the GPS are entered using the **Preferences** tab of **System Properties**, shown in FIGURE 19-13.

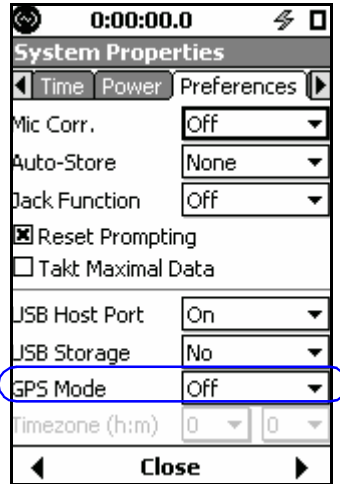

FIGURE 19-13 Preferences Tab

For a detailed description of the GPS setup procedure, see "GPS Mode" on page 18-18.

GPS Data Display

When the GPS feature is enabled by the user, the display shown in FIGURE 19-14 will appear on the **Live** tab, just above the "Time, Battery Voltage and Memory" display shown in Figure 5-11 on page -5-11.

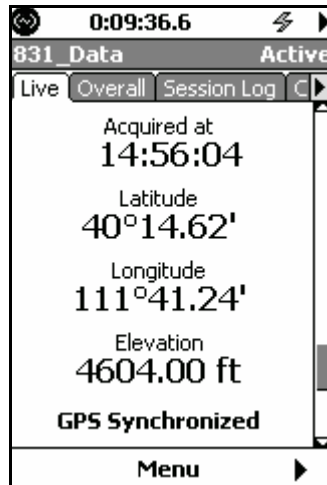

FIGURE 19-14 GPS Display

The GPS will turn on automatically at the beginning of every measurement run to acquire the current position information. The Live GPS display will show the data from previous acquisitions instead of clearing the data when the GPS is off. They will be cleared on if there is a GPS connect/disconnect error.

GPS Time-Sync

The time-sync is made from the average of thirty readings from the satellite (thirty second average) as long as there are four or more satellites detected. The time-sync can be performed manually or automatically when the Daily Autostore mode is active.

Manual

Note that the manual time sync can only be performed while the instrument is stopped.

A time-sync can be triggered manually by pressing the  (ENTER) key from the GPS display, shown in FIGURE 19-14.

Daily Autostore

A time-sync will be performed along with a Daily Autostore if the time is found to be more than one second off. In this case, the GPS is turned on two minutes prior to the autostore time in order to gather the time and create the time correction value that will be utilized.

Datum

The GPS uses WGS 84 as its default datum. The user can change the datum as described in the Ho lux manual.





Communication

The Communication tabs are used to setup communications between the Model 831 and a PC using dial-up modems, GSM cellular telephones and RS-232 devices.

Control Panel - Communication

Most of the communication settings in the Model 831 can be configured using the G4 LD Utility software.

Communications between the Model 831 and a PC are implemented using G4 LD Utility. This chapter explains how to set the Model 831 for these communications.

To activate the Communication tabs, press the  (TOOLS) key. Use the , ,  or  keys to highlight the Communication icon as shown in FIGURE 20-1. Navigate down the Control Panel display to see the **Communication** Icon.

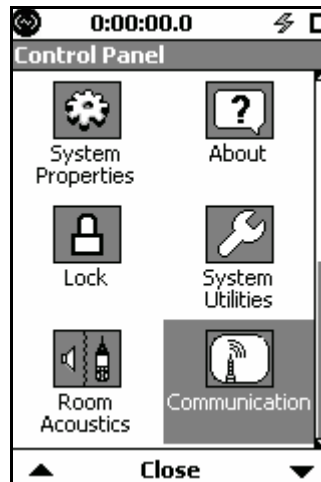

FIGURE 20-1 Control Panel

Press **ENTER** (ENTER) to open the Communication tabs, as shown in FIGURE 20-2.

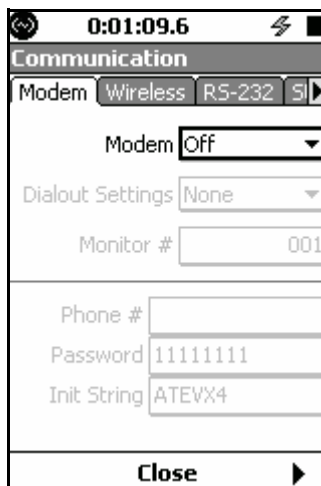

FIGURE 20-2 Communications Tabs

There are four possible tabs, as follows:

- Status
- Mode
- Wireless
- RS-232

The **Status** tab is used to monitor the status of the USB and RS-232 ports. The next three are used to setup the three different modes of communication available with the Model 831.

Modem Tab

In order to setup to use an analog USB modem, the USB Host Port must be set to On, as described in “USB Host Port” on page 18-14.

The **Modem** tab, shown in FIGURE 20-3, is used to implement communication using a MultiModem USB Analog modem and either telephone lines or dedicated lines.

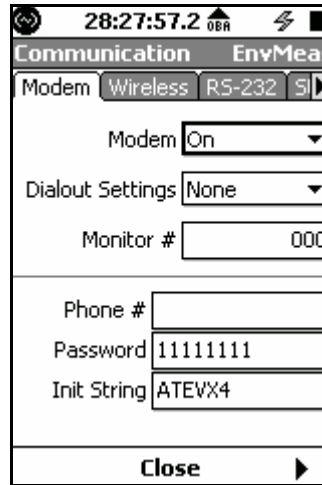

FIGURE 20-3 Communication: Modem Tab

Most of the data fields call for direct entry of parameters. The Modem and Dialout Settings utilize drop-down menus as follows.

If you attempt to enable more than one device, the warning message shown in Figure 20-4 appears.

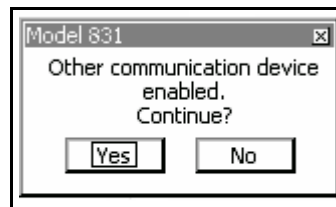





FIGURE 20-4 Multiple Communication Device Warning

Modem

The Modem field turns **On** or **Off** the modem. Use the  and  keys to highlight the Modem field and press  to open the Modem Menu, shown in FIGURE 20-5.

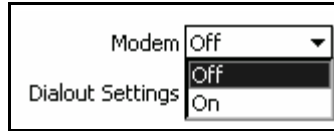







FIGURE 20-5 Modem Menu

Use the  or  key to highlight **On** or **Off** and press the  key to make the selection.

Dialout Settings

The Dialout Settings defines when the modem is to dial up the computer. Use the  and  keys to highlight the Dialout Settings field and press  to open the Dialout Settings Menu, shown in FIGURE 20-6.

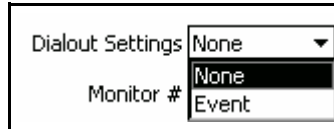





FIGURE 20-6 Dialout Settings Menu

None

The Model 831 will not dial the designated phone number for any reason

Event

The Model 831 will dial the designated phone number when a valid occurs and the max of the event is greater than SPL 2 or the peak of the event is greater than Peak 3 as defined in the trigger setting described in “Level Trigger Method” on page 13-4. This feature provides the user with the ability to log many events but only receive a call for the worst event. However, should the user desire to receive a call for all events, then SPL 2 can be set equal to SPL 1 and Peak 3 can be set equal to Peak 1.

Use the  and  keys to highlight the desired setting and press  to make the selection.

Monitor

Monitor number is used when there are multiple noise monitoring sites which can communicate with the computer. Assign these as desired.

Phone Number

This is the telephone number that the 831 will dial when configured to dial on exceedance or alarm.

Password

The SLM Utility-G3 will not connect unless the password sent by SLM Utility-G3 matches the password stored within the Model 831. This is a security feature to prevent unwanted access by someone who has the telephone number.

Init String

This is a string sent to the modem to initialize it. The string shown in FIGURE 20-3 is the default. For PCB provided modems, this does not need to be changed and the default will work correctly. This parameter is made available for the situation where a user wishes to use some other modem.

Setup

Step 1 Use the System Properties **Preferences** tab to set the USB Host Port On.

Step 2 From the Communications tabs, use the **Modem** tab to set the modem **On**.

Step 3 Connect the modem to the USB Hub. When you connect the modem the following events should happen.

- The 'TR' LED would turn on
- The "DATA" LED would glow and turn off immediately
- The 'TR' LED would stay turned on.

Step 4 Connect a powered USB hub onto the 831.

Step 5 Now the 831 is ready for incoming connections. The status and state of the USB modem can be checked on the **Status** tab discussed in "" on page 20-27.

Common Pitfalls in Analog Modem Communication:

- Ensure that the analog modem (MDMUSB-A) is connected to the 831-INT or a powered USB Hub. It will not work if connected directly to the Model 831 as it cannot supply sufficient power.
- Check if the modem is connected to a standard analog phone line (sometimes called POT line)
- For help with remote communication problems, see "Communications Watchdog" on page 20-13 in this chapter.



Wireless Tab

In order to setup to use a wireless modem, the USB Host Port must be set to On, as described in "USB Host Port" on page 18-14.

The **Wireless** tab, shown in FIGURE 20-7, is used to implement wireless communication using GSM networks.

28:27:57.2
Communication EnvMeas
Modem Wireless RS-232 5
Wireless Modem On
APN
isp.cingular
APN Username
ISPDA@CINGULARGPRS.COM
APN Password
CINGULAR1
Password
11111111
Close

FIGURE 20-7 Communication: Wireless Tab

The Wireless field turns On or Off the wireless modem. Use the  and  keys to highlight the Wireless Modem field

and press  to open the Modem Menu, shown in FIGURE 20-8.

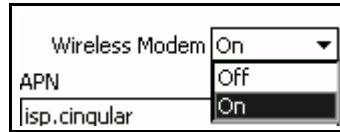





FIGURE 20-8 Modem Menu

Use the  or  key to highlight **On** or **Off** and press  to make the selection.

APN

Each cellular provider has a unique APN (Access Point Name) which is to be entered into this field.

APN Username/APN Password

Some cellular providers will also supply a specific APN Username and Password which must be entered into these fields.

Password

The password field is for a user-defined password that will be used to authenticate with an application, such as SLM Utility-G3.

Setup

Step 1 Use the System Properties **Preferences** tab to set the USB Host Port On.

Step 2 From the **Communications** tabs use the Wireless tab to set the wireless modem On.

In addition to a Model 831 with firmware version V1.5 or higher, the following devices are required:

- Model 831 Option file with the Advanced Communication option.
- MultiModem EDGE wireless modem with firmware 2.0 or higher
- SIM Card (with a data plan)
- Powered USB Hub

Step 3 Insert the SIM card and write down the telephone number.

Step 4 Connect a Powered hub onto the 831.

Step 5 Connect the MultiModem EDGE to the USB Hub.

Boot sequence for the Modem runs as follows:

- The 'PWR' LED would turn on.
- The 'TR' LED would turn on.
- The 'TR' LED should stay turned on.

Step 6 Wait for 3 minutes. Model 831 is ready for incoming connections. The status of the modem can be verified on the Communication ->Status screen, described in“” on page 20-27.



FIGURE 20-9 Status Tab

RS-232 Tab

Note: Connections via the RS-232 are slow compared to direct USB connections.

The RS-232 option is an alternative direct connection method for communicating with the Model 831. There are two basic scenarios in which the RS-232 connection may be superior to a USB connection:

- The computer being utilized does not have a USB port.
- The length of the connecting cable exceeds sixteen feet (USB cables have a maximum usable length of 5 m or 16.5 feet while RS-232 cables can be up to 15.24 m or 50 feet long. However, both cable types can be extended by using power hubs).

Required Components

The following are required to connect via the RS-232 interface:

WARNING: There can only be one DVX008A connected to a Model 831 system at a time. Connecting more than one will result in undesirable behavior.

- A USB-to-RS-232 adaptor (DVX008A)

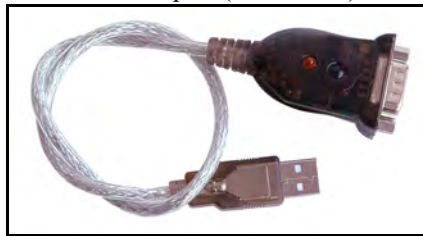

FIGURE 20-10 DVX008A

- An RS-232 null modem connection (either a null modem cable (CBL117) or a null modem adaptor)



FIGURE 20-11 Null Modem Cable

- A computer with a serial port connector and an available COM port
- A Model 831 with the 831-MDM option installed and enabled.

Setup

Step 1 From the Communications tabs use the **RS-232** tab to set the RS-232 to **On**.

Step 2 Connect one end of the null modem connector to the serial port of the computer.

Step 3 Connect the other end of the null modem cable to the USB-to-RS-232 adaptor (DVX008A).

Step 4 Connect the DVX008A to the USB port on the Model 831.

Step 5 Ensure that the USB port has been enabled as described in “USB Host Port” on page -18-14.

Step 6 Use the Communication **RS-232** tab, shown in FIGURE 20-12, to set the **RS-232** option to **On**, as shown in FIGURE 20-13.

*The status and state of the wireless modem can be checked on the **Status** tab.*

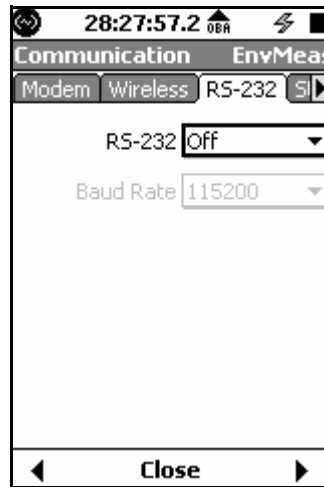

FIGURE 20-12 Communication: RS-232 Tab

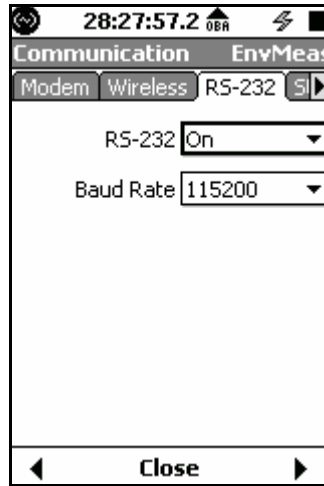

FIGURE 20-13 RS-232 Menu

Step 7 Set the desired Baud rate as shown in FIGURE 20-14.

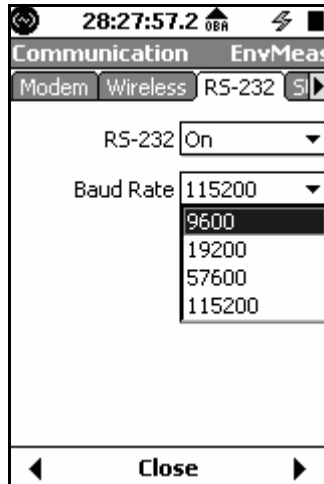

FIGURE 20-14 Baud Rate Menu

Troubleshooting Tips

If the connection is not using the Larson Davis SLM Utility-G3 software on the PC, it is required that the *slmserver* portion of the SLM-Utility-G3 software be installed to communicate with the Model 831 since there is not currently an ASCII character-based command set for RS-232 communication.

If the connection does not establish itself after a few moments, verify the following settings on the COM port configuration on the PC side:

- Baud Rate: User selectable metric; must match the connection rate on the instrument end.
- Flow Control: None
- Data Bits: 8
- Stop Bits: 1
- Parity: None

SMS Out

The SMS Out tab provides options for receiving text message alerts for events or conditions as they happen on the meter. You can send up to three different alerts for specified conditions.



Specify condition for text message to be sent.

Specify phone number to receive text message.

For SMS event detection, SPL2, not SPL1, is used as a trigger for sending alerts.

FIGURE 20-15 SMS Out Tab

Network Tab

The password on the **Network** tab is used to secure the Model 831 remotely over a network. If the password is forgotten, the Model 831 can be accessed by unlocking the meter itself in person.

The **Network** tab also displays 831-INT-ET and Communications Watchdog information.

Communications Watchdog

The Communications Watchdog reboots the Model 831 system in the events of a communication failure with either the 831-INT-ET or the analog modem.

831-INT-ET

The only time this control needs to be changed by a user is if the Model 831 is used with an 831-INT-ET and subsequently moved to an 831-INT. For more information, see the 831-INT Manual.

The Communications Watchdog is automatically enabled when the Model 831 is connected to the 831-INT-ET Docking Station. The option can be disabled on the **Network** tab, as shown in FIGURE 20-16.

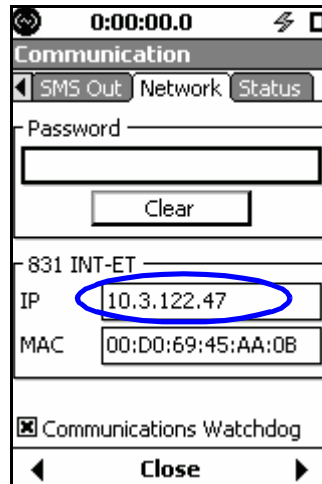

FIGURE 20-16 Network Tab

*A Model 831 in an 831-INT with the watchdog enabled will reboot each time the watchdog count expires. To prevent this, disable the watchdog on the Communication **Network** tab.*

On some older Model 831 meters, the timeout limit may be increased.

If the Communications Watchdog is enabled, the watchdog count will be displayed on the **Preamp** page of the **Live** tab. The count tells how many seconds remain until the system will reboot. The watchdog timeout starts after 300 seconds, or 5 minutes, on the countdown, as shown in Figure 20-17.

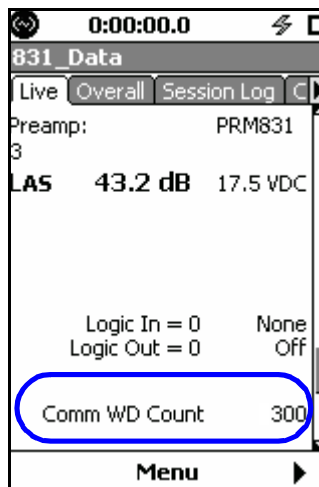

FIGURE 20-17 Communications Watchdog Countdown

When the Communications Watchdog timer expires, a record is created in the Session Log, as described in "Session Log Tab" in the "Data Display" chapter.

Analog Modem Connection

If an analog modem that is connected to a remote Model 831 does not respond to initialization commands after a period of 10 minutes, the Model 831 will reset the analog modem by power cycling the USB host port.

If a USB flash memory drive is connected and copying data, the Model 831 will wait until the data has been copied completely before performing the USB host port power cycle.

After the USB host port power cycle is complete, you can then re-establish remote connection to Model 831 through

the analog modem. The event is indicated in the Session Log, as shown in Figure 20-18.

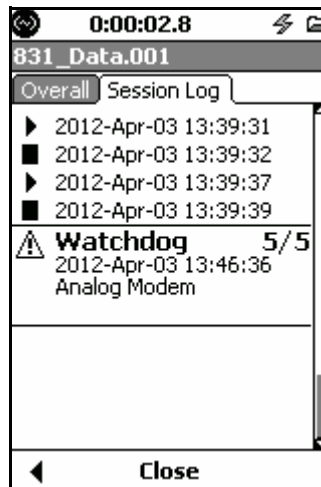

FIGURE 20-18 Analog Modem Reset

Status Tab

This tab allows tracking of the status and state of attached communication devices.

There are four separate channels that can be monitored. Analog, Wireless, RS-232 and USB depending on which type of device you have connected.

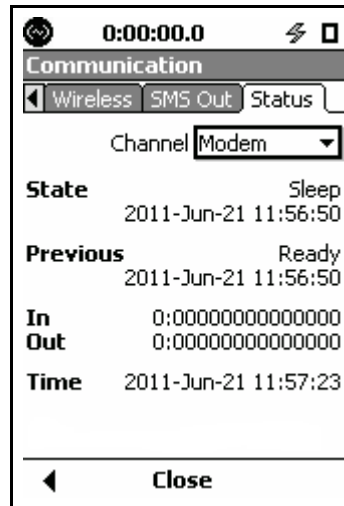

FIGURE 20-19 Status: Analog Modem

State

Note: A list of the most common State values is presented in the section “States” on page 20-19.

Displays the current state that the device is in along with a time stamp signifying when the device entered that state. A **Ready** state signifies that the device has been initialized and is ready for use.

Previous

Shows the previous most recent state the device was in along with the time stamp that the state was entered. This is useful as it enable the use to more easily follow the progress of the device as it moves through all possible states.

In

A representation of the last data packet received on this data channel

Out

A representation of the last data packet sent on this data channel

Time

Displays the current date and time of the unit



FIGURE 20-20 Status: Wireless Channel

State

Note: A list of the most common State values is presented in the section “States” on page 20-19.

Displays the current state that the device is in along with a time stamp signifying when the device entered that state. An SMS Wait state signifies that the device has been initialized and is waiting for a connection request.

RS-232

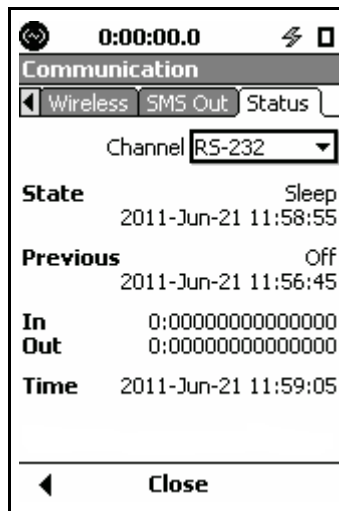

FIGURE 20-21 Status:RS-232

USB

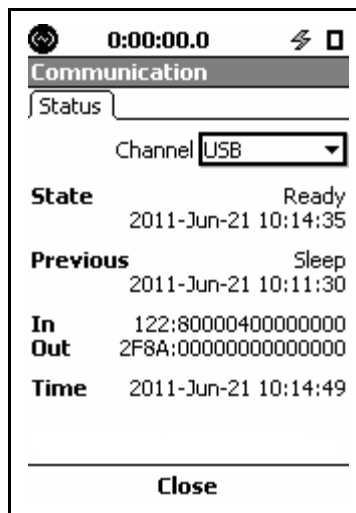

FIGURE 20-22 Status: USB Channel

States

There are many possible states that each device can be in. This section lists the most common ones.

Connect Wait

The wireless modem has successfully registered and communicated with an application. This state will persist for 2 minutes before moving on to the next state.

Connected

The device is connected to and is being remotely controlled by an application (G3-utility)

Device Found

A device has been found on one of the communication channels and is being identified.

Disconnected

The device has been disconnected from the remote application.

Initializing

The connected device is currently being initialized.

Internet

The wireless modem is connected to an IP address.

Sleep

It is only possible to have one device communicating at a time. If you attempt to enable or use more than one device the currently active device will enter a sleep state.

FIGURE 20-23 shows the wireless channel in a sleep state as a result of a USB device also being connected to the model 831 at the same time.

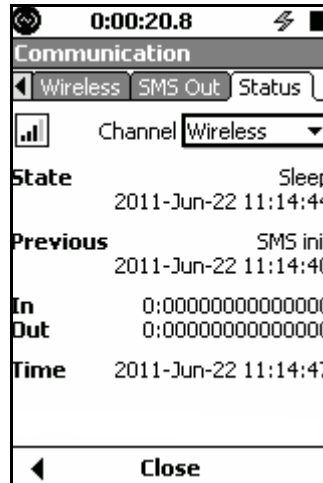

FIGURE 20-23 Sleep State Menu

SMS Init

The wireless modem has registered on the network

SMS Merge

When an SMS message has been sent via email and is too large (>160 bytes) it is broken up and reassembled. This state signifies that multiple SMS messages are being reassembled.

SMS Received

An SMS message has been received by the device

SMS Wait

The wireless modem is ready to receive an SMS message requesting connection.

Troubleshooting

When a connection to the Model 831 cannot be made via the wireless modem, the following procedure is recommended.

Verify that the modem is enabled on the communications tab and that the USB host port is on. A few minutes after connecting, the PWR and TR lights should be illuminated on

the modem and the modem **Status** tab should show the state as SMS wait.

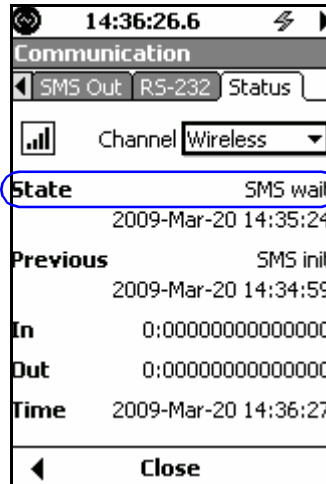

FIGURE 20-24 Status SMS Wait

If the connection has not been made, verify that the default baud rate for the wireless modem is set to 115.2k, verify that the wireless signal strength is adequate and verify that the modem firmware version is 2.00 or greater. This can be done by connecting to the wireless modem using a hyper terminal program.

Installing the Wireless Modem USB Driver

Step 1 Connect one end of the USB cable to the modem and the other end to the PC.

Step 2 Place the wireless modem CD into the PC's CD-ROM drive and plug the USB cable into the PC. The Add New Hardware Wizard will display. Please follow the installation prompts.

Wireless Modem USB Baud Rate Setup

Step 1 After installation go to the **Control Panel > Systems > Device Manager**. Right-click the installed modem and select **Properties**, as shown in Figure 20-25.

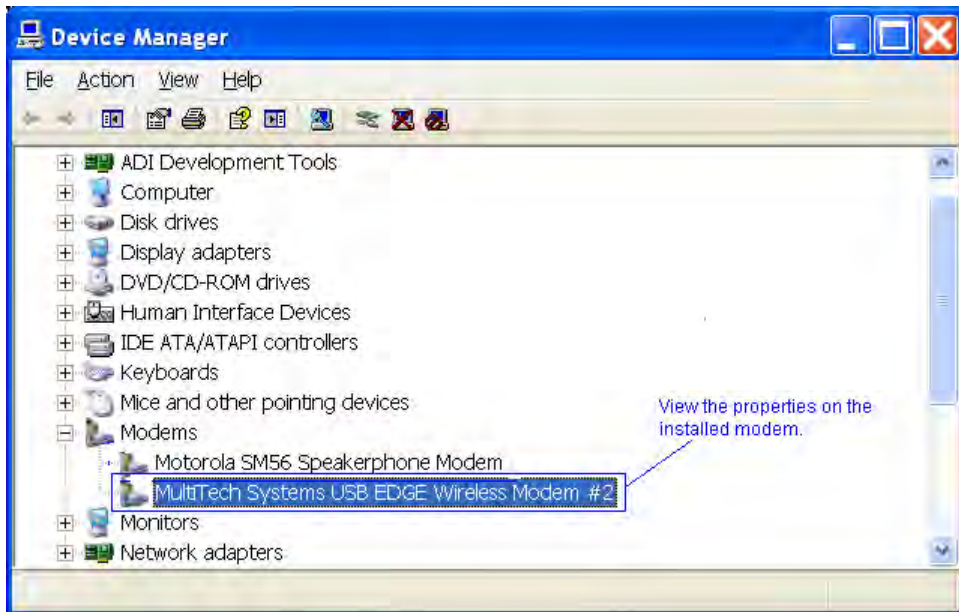

FIGURE 20-25 View Modem Properties

Step 2 From the Edge **Modem** tab, note the COM Port displayed. Use this information in the EDGE Setup Document.

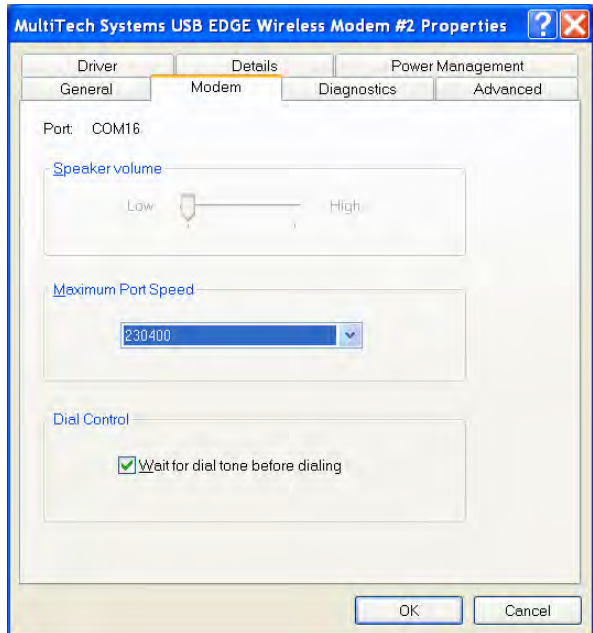

FIGURE 20-26 COM Port Information

Step 3 Open your Windows HyperTerminal program. This will launch the Connection Description dialog box. In this dialog box, enter a name and click **OK**, as shown in Figure 20-27.

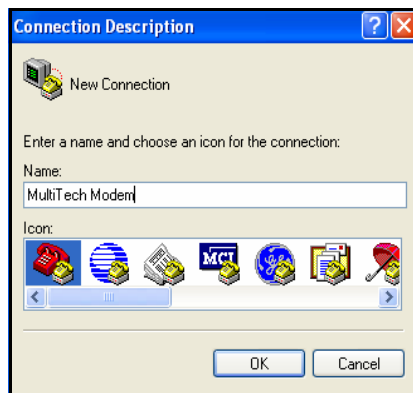

FIGURE 20-27 Connection Description

Step 4 In the **Connect Using** drop down menu, select the COM port to which the Modem is connected (This can be found from the device manager settings. Click **OK**.



FIGURE 20-28 COM PORT Selection

Step 5 In **Properties** specify the following settings.

- Bits per second: 230400
- Data bits: 8
- Parity: None
- Stop bits: 1
- Flow control: Hardware.

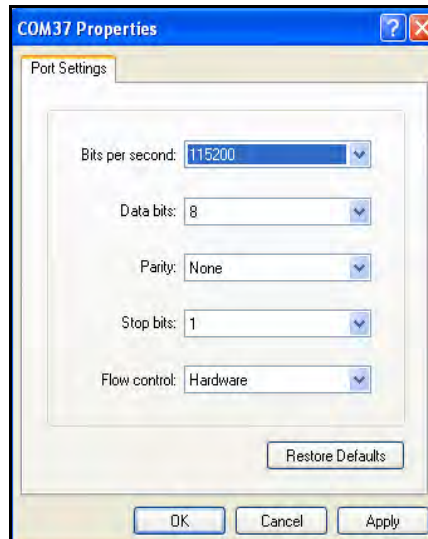

FIGURE 20-29 Port Settings

Step 6 From the **Modem Properties** dialog box click the **ASCII Setup** button and specify the following:

- Enable **Send line ends with line feeds**.
- Select **Echo typed characters locally** (if the characters you type in the next step are duplicated, return to this step and uncheck this box).

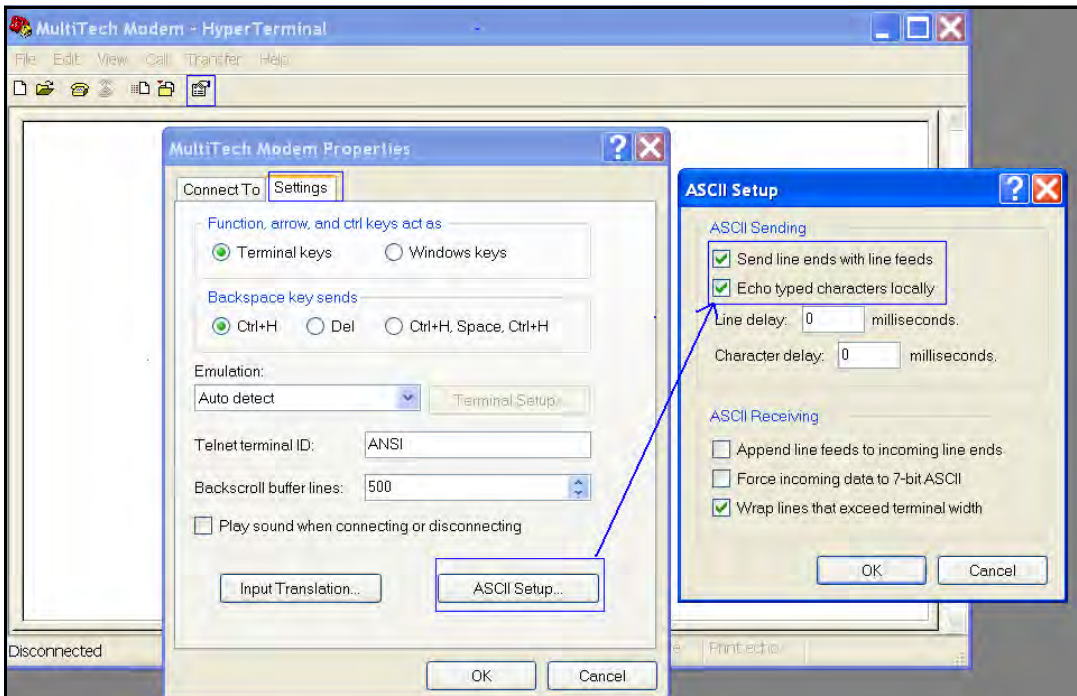

FIGURE 20-30 ASCII Setup

Step 7 Go to the AT window and type **OK**. If the response is correct, go to Step 9. Otherwise, proceed with Step 8.

Step 8 Go to **Modem Properties** and change the bits per second to 115200 rate and retry step 9.

Step 9 Type **AT+IPR?** The response should be 230400. Type **AT+IPR=115200**.

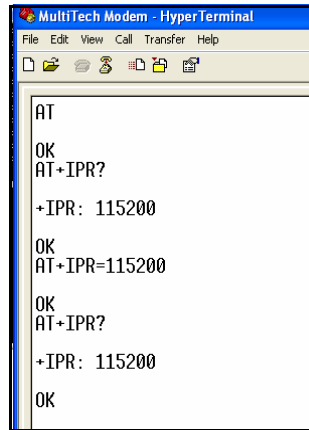

FIGURE 20-31 AT Window

Step 10 This change will cause communication with the modem to cease. Return to the Modem Properties dialog box and set the baud rate to **115200**. Reconnect to the modem

Step 11 Type in the AT Window. Verify that it responds with **OK**.

Step 12 Type **AT+IPR?** The response should be 115200.

Verify Signal Strength and Error Rate

Step 1 Type **AT+CREG=1**.

Step 2 Type AT+CSQ. This will return a value pair.

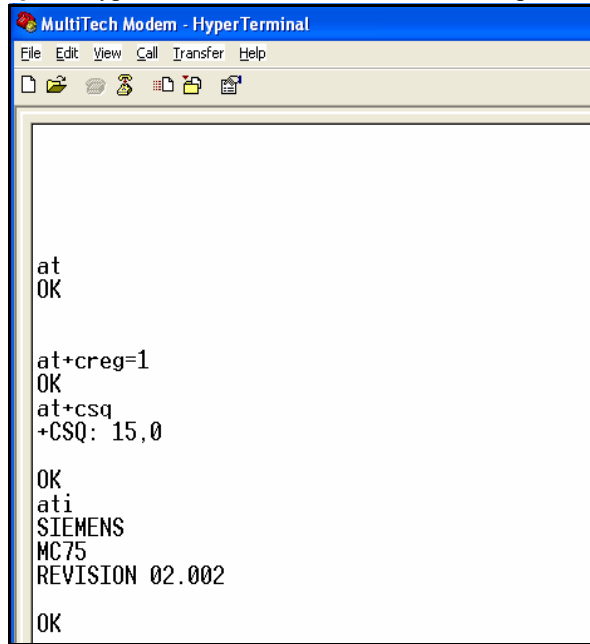

```
MultiTech Modem - HyperTerminal
File Edit View Call Transfer Help
[at]
OK

[at+creg=1]
OK
[at+csq]
+CSQ: 15,0

OK
[ati]
SIEMENS
MC75
REVISION 02.002

OK
```

FIGURE 20-32 Verifying Signal Strength and Error Rate

The first number (possible values 0-30) is the signal strength. Any number less than 10 may mean the signal is too weak for reliable communication. The second number (possible values 0-7) is the error rate. For more specific details, refer to the Multi Modem manual.

If the modem will not connect after all of these steps, the firmware version should be verified.

Verify Firmware Version

In the HyperTerminal window type ATI. The firmware version number will be displayed. Revision number 2.00 or higher should be displayed for the modem to work properly. If it displays a lower version number, you will need to return the modem to MultiTech or to the place of purchase for a firmware upgrade.

Lock/Unlock the Model 831

To prevent unauthorized use or tampering with measurements and data, the Model 831 has a lock feature. When this is enabled, the Model 831 is tamper proof to a level selected by the user. There are 4 levels of security provided by this feature.

Control Panel - Lock



To activate the Lock page, press the  (TOOLS) key and highlight the Lock icon as shown in FIGURE 21-1.



FIGURE 21-1 Control Panel

Press the  (ENTER) key to open the Lock page.

There is one Lock page. There are three items on this page the user may configure.

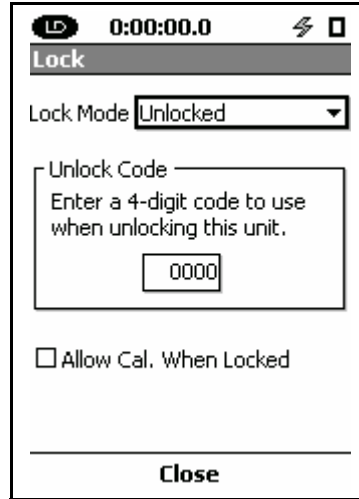

FIGURE 21-2 Lock Page

Highlight the Lock Mode list box. Press **ENTER** to drop down the list.



FIGURE 21-3 Lock Mode List

Highlight the desired lock mode. Press **ENTER** to accept the selection.

Lock Modes

Unlocked

The user has complete access to the features of the instrument.

Lock w/Auto-Store

The user cannot change the data view in this mode. Only the status line at the top of the screen is updated. A measurement may be running when this mode is enabled or pressing the **▶/||** (RUN/PAUSE) key will begin a measurement. A measurement cannot be paused. Pressing

the  (STOP/STORE) key stops the run and stores the data but does not reset the measurement. See Chapter 21 "Locked With Auto-Store" on page 21-6.

Lock w/Manual Store

In this mode, the Auto-Store preference is disabled, see Chapter 18 "Preferences" on page 18-10.

The user cannot change the data view in this mode. Only the status line at the top of the screen is updated. Measurements may be run, paused and stopped. See Chapter 21 "Locked With Manual-Store" on page 21-7.

Fully Locked

The user has no access to the instrument, except to start a run. Auto-Store preferences are enabled in this mode. See Chapter 21 "Fully Locked" on page 21-5.

A measurement cannot be reset when the Model 831 is locked in any mode.

Unlock Code

Move the highlight to the Unlock Code Field.

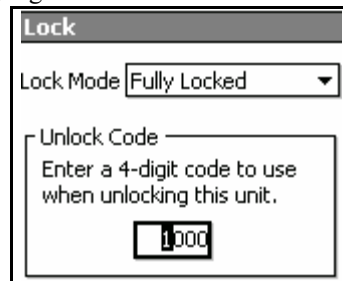



FIGURE 21-4 Unlock Code

Press the  key. The 1st character in the field will be highlighted. Enter the desired lock code and press the  key to accept the new unlock code .

Press the **Close** soft key to exit the Lock page.

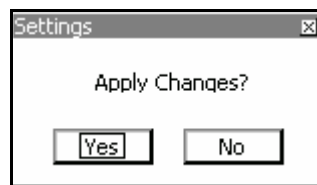

FIGURE 21-5 Apply Changes

Highlight **Yes** or **No** and press the **ENTER** key to complete the process.

Allow Cal When Locked

Move the highlight to **Allow Cal. When Locked**. Pressing the **ENTER** key will toggle the state of the check boxes shown in FIGURE 21-6. If the box is checked, calibration will be allowed while the unit is locked, but not running a measurement.

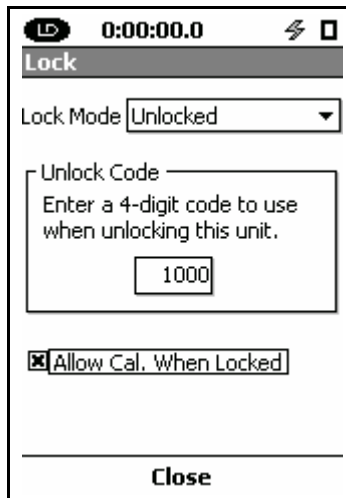



FIGURE 21-6 Allow Cal Check Box

Fully Locked



FIGURE 21-7 Fully Locked

If you have selected Fully Locked for the Lock Mode, upon accepting the changes, FIGURE 21-7 represents the view you will have. At this point, the instrument is not running a measurement. It is possible to select the Fully Locked mode while a measurement is in progress.

Pressing the  key will start a measurement by bring up the following message box.

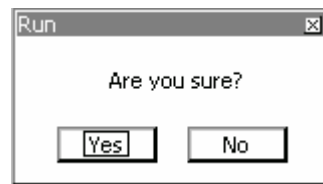



FIGURE 21-8 Are You Sure

Highlight **Yes** and press the  key to begin the measurement. A measurement cannot be Paused, Stopped or Stored in the Fully Locked mode.



To unlock the Model 831, press the  (TOOLS) key.



FIGURE 21-9 Unlock

The  key or the Right or Left Softkey may also be used.

Enter a 4 digit code, then press .

The Model 831 is unlocked and all functions are available to the user.

Locked With Auto-Store

If the Locked w/Auto-Store mode has been selected, upon accepting the changes on the Lock page, the view would look as shown in FIGURE 21-10.

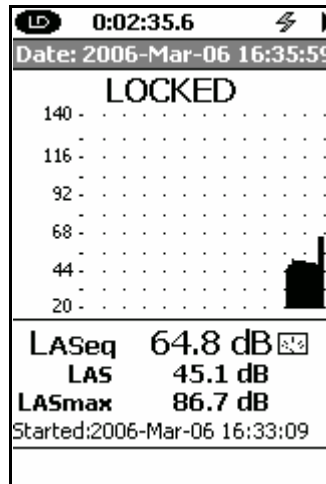



FIGURE 21-10 Locked with Auto Store or Manual Store

In this mode, measurements may be started by pressing the  key. A measurement may not be Paused or Stopped. Pressing the  key will initiate storing the data file.

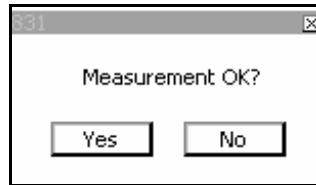







FIGURE 21-11 Auto-Store-Stop

Highlight the desired response and press . If **Yes** is selected, the data file will be saved. The unit is still locked and a new measurement may be started by pressing the  key. If **No** is selected, the data is reset and a new measurement may be made.

Unlock

To unlock the model 831, press the  key,  or the right or left softkey. Enter your 4 digit code, then press .

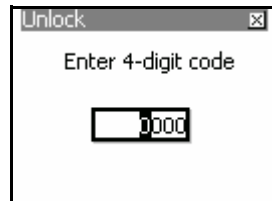





FIGURE 21-12 Auto-Store Unlock

The Model 831 is unlocked and all the functions are available to the user.

Locked With Manual-Store

If the Locked w/Manual-Store mode has been selected, upon accepting the changes on the Lock page, the view would be as shown in FIGURE 21-10.

In this mode, a measurement is started by pressing the  key. Pressing the  key a second time will pause the measurement and pressing it again will continue the measurement.

The  key will stop a measurement. Pressing it a second time will initiate the storage process by displaying the “Save File” prompt as shown in FIGURE 21-13.

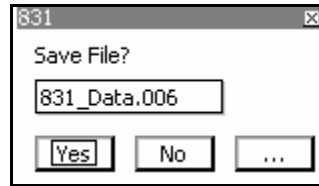





FIGURE 21-13 Manual Store When Locked

Press **Yes** to store into the file number indicated, **No** to abort the storage operation or... to overwrite a file into which data has already been stored.

Unlock

To unlock the Model 831, press the  key, the  key or the Right or Left Softkey. Enter your 4 digit code, then press .

Calibration When The Model 831 Is Locked

When the Model 831 is in any of the lock modes, and is stopped, the unit may be calibrated. This is only possible if the “Allow Cal. When Locked” check box, on the Lock page, has been checked previous to entering Lock mode.

If the Center Softkey indicating **CAL** is active, as shown in FIGURE 21-14, press this key. This will bring up the

calibration screen. See Chapter 8 "Calibration" on page 8-1 for complete details on calibrating the Model 831.



FIGURE 21-14 Locked with Calibration Permitted

About

The About tabs give summary information concerning the instrument, available options, and instrument identification.

Control Panel - About



To activate the About tabs, press the  (TOOLS) key and highlight the About icon as shown in FIGURE 22-1.



FIGURE 22-1 Control Panel

Press the  (ENTER) key to open the About tabs.

There are three About tabs that may be selected using the Right and Left Softkeys. All About tabs have one page. No user input is required on these pages.

About

This tab gives you important information, such as Serial Number and Firmware Revision. See FIGURE 22-2.



FIGURE 22-2 About Tab

Standards

The **Standards** tab lists the standards that the 831 meets. See FIGURE 22-3.

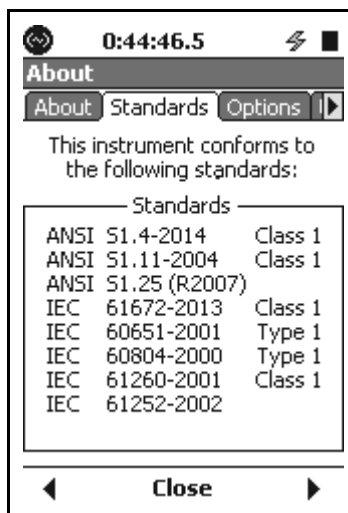

FIGURE 22-3 Standards Tab

Options

The **Options** tab lists available options for the Model 831. A check mark next to an option indicates that the option is enabled. See FIGURE 22-4.



FIGURE 22-4 Options Tab

Scroll down to see more options than shown in this graphic.

Options may be added at any time, even when you are in the field. For more information, call one of the telephone numbers listed on the back cover or contact your local representative, listed under “Sales” on the Larson Davis web site www.LarsonDavis.com.

User

This tab displays any identifying information the user may have entered on the System Properties **Device** tab or when using SLM Utility-G3 software.

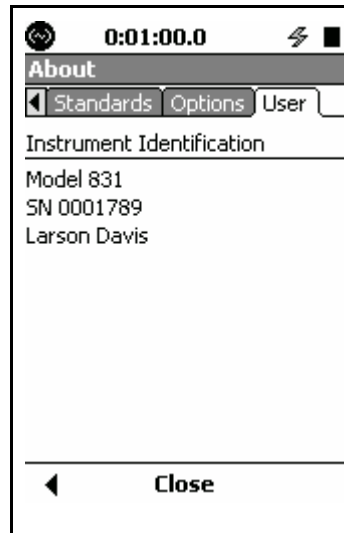



FIGURE 22-5 User Tab

System Utilities

The System Utilities displays the File System tab, which can be used to repair or recover from file system problems.

Control Panel - System Utilities

Press the  key one time in order to see the System Utilities icon on the Control Panel.



To activate the System Utilities, press the  (TOOLS) key and highlight the System Utilities icon as shown in FIGURE 23-1.



FIGURE 23-1 Control Panel

Press the  (ENTER) key to display the File System tab.

File System

The **File System** tab is used to repair or recover from file system problems. The functions available on this tab are similar to function that would be used to manage a hard drive. See FIGURE 23-2.

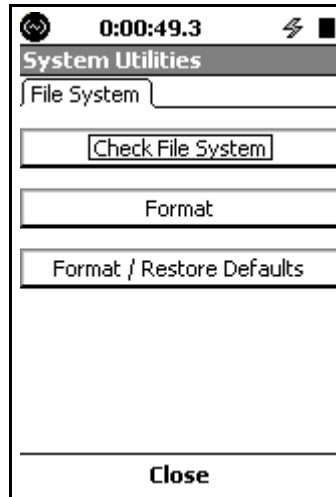

FIGURE 23-2 File System

The five functions on the **File System** tab are

- Check File System
- Format
- Format & Restore Defaults

Highlight the desired function and press **ENTER** to initiate this operation.

Warning!

Using these functions may cause a loss of data return the Model 831 to default conditions upon restoration.

The user should only activate these functions if there appears to be a problem.

Check File System

These utilities will detect and repair file system problems.

When the Check File System button is selected, the Model 831 will check the file system in the Model 831, similar to Check Disk on a PC. If a problem is detected, an attempt will be made to repair the problem.

Format

Selecting this function will format the internal data storage area in the memory of the Model 831. This operates similar to the Format function on a PC. System preferences and settings are preserved.

Format & Restore Defaults

WARNING!

User calibrations and calibration history data are erased when this function is implemented.

Selecting this function formats the internal data storage area in the memory of the Model 831. The Model 831 is then restored to factory settings.

The Format and Format & Restore Defaults function will erase all internal data files, but it will not affect data stored in USB memory.

Parameters Measured

This chapter describes the different acoustic parameters which can be measured, displayed and stored using the Model 831.

Basic Sound Level Measurements

Frequency Weighting

See “SLM Tab” on page 4-4

Each of the sound level parameters measured at one time will be frequency weighted as set by the user from the **Settings** tab. The frequency weighting for RMS and Impulse averaged sound levels will be the same, selected independent from the frequency weighting for peak detection.

RMS and Impulse Weighting

The Model 831 measures RMS and Impulse averaged sound level values using one of the following user-selected frequency weightings:

- A-Weighting
- C-Weighting
- Z-Weighting

Peak Weighting

The Model 831 measures peak sound level values using one of the following user-selected frequency weightings:

- A-Weighting
- C-Weighting
- Z-Weighting

RMS Averaging

The exponential averaging time for RMS sound levels is set to one of the following:

- Slow
- Fast

An impulse detector is also available.

Sound Level Metrics Measured

In Table 24-1 "Sound Level Metrics Measured" the symbol X is used to represent the user-selected RMS and Impulse frequency weighting (A, C or Z) and the symbol Y is used to represent the user-selected peak frequency weighting (A, C or Z).

Metric	Selected RMS Averaging		Impulse	Peak	Integrated
	Fast	Slow			
Instantaneous Sound Level	L_{XF}	L_{XS}	L_{XI}	L_{Ypeak}	
Maximum Sound Level	L_{XFmax}	L_{XSmax}	L_{XImax}	$L_{Ypeak(max)}$	
Minimum Sound Level	L_{XFmin}	L_{XSmin}	L_{XImin}		
Equivalent Level			L_{XIeq}		L_{Xeq}

Table 24-1 Sound Level Metrics Measured

1/1 and/or 1/3 Octave Frequency Spectra

The Model 831 can perform just 1/1 or 1/3 octave real-time frequency spectra measurements or they can both be measured simultaneously. These spectra will be made using a user-selected frequency weighting (A, C or Z). The averaging time is the same as that selected for the sound level measurements (Fast, Slow or Impulse).

Spectral data is displayed on both the **Live** and **Overall** tabs, but only the Overall Data can be stored.

Live Tab

From the Live tab, the graphic shows the instantaneous SPL value for all frequencies and the bar to the far right shows the summation value for the entire frequency band. The value corresponding to the cursor position is displayed numerically beneath the graph.

Overall Tab

From the Overall tab, the graphic shows the energy equivalent level calculated over the measurement time period at each frequency band and, at the far right, for the summation of all frequency bands. The values displayed digitally beneath the graph represent the following data for the frequency band at the cursor position.

- Leq
- Lmax
- Lmin

Sound Exposure Metrics Measured

See Chapter 9 "Industrial Hygiene" on page 9-1

The Model 831 measures two separate and independent sets of sound exposure metrics.

The following parameters are user-selectable:

- Exchange Rate: 3, 4, 5 or 6 dB
- Threshold Enable: Yes or No
- Threshold Level: Numeric entry
- Criterion, Level and Hours: Numeric entries

In Table 24-2: "Sound Exposure Metrics Measured" the symbol X is used to represent the user-selected RMS and Impulse frequency weighting (A, C or Z) and the symbol Y is used to represent the user-selected peak frequency weighting (A, C or Z).

The symbol V is used to represent the user selected time weighting (F, S or I)

Metric	Symbol
Sound Exposure Level, SEL	L_{XVE}
Average Sound Level, Lavg	L_{Xavg}
Time Weighted Average Level, TWA(x)	TWA(s)
Noise Dose	DOSE
Projected Noise Dose	ProjDose
Daily Personal Noise Exposure, Lep,d	LXep,8
Sound Exposure, E	E_{XV}
Projected 8 Hour Sound Exposure	E_{XV8}
Projected 40 Hour Sound Exposure	E_{XV40}
SEA	SEA

Table 24-2: Sound Exposure Metrics Measured

Statistical Metrics Measured

Broadband Statistics

For setup of Ln Statistics, see “Ln Tab” on page 4-7

Statistical sound level parameters are very useful for characterizing time-varying sounds such as environmental noise. A widely used parameter is Ln, which represents a sound level which is exceeded n% of the measurement time. For example, L₉₀ is often used as a measure of the background noise since it is exceeded 90% of the time.

The Model 831 can calculate and display six different Ln statistical parameters using the frequency weighting (A, C or Z) and exponential averaging (Slow or Fast) selected when setting it up for a sound level measurement. These six values are user-selected over the range L_{0.01} to L_{99.99}.

The SLM Utility-G3 software permits the distribution table from a saved measurement to be exported to a spreadsheet which could then be utilized to calculate any possible value of Ln over the range L_{0.01} to L_{99.99}.

To determine broadband statistics, the sound level is sampled every 10 ms. into 0.1 dB wide amplitude classes over a 199 dB span. The resulting table, from which all values of Ln between L_{0.01} to L_{99.99} can be calculated, is referred to as the distribution table. This distribution table is saved whenever an overall measurement is saved.

Although the six percentage values are user-defined as part of the setup, these can be changed without resetting or stopping a measurement, in order to display different values of Ln.

Measurement History

When making automatic sequential measurements using the measurement history feature, a distribution table is saved for each measurement interval.

Spectral Statistics

When the spectral Ln mode has been enabled in the frequency spectrum setup, the Model 831 will measure and store spectral statistical data in addition to broadband statistical data.

Spectral statistics are similar to broadband statistics except that values of Ln are determined for every frequency band in the measured spectrum. To determine spectral statistics, the sound level in every frequency band is sampled every 100 ms. into 0.1 dB wide amplitude classes over a 199 dB span. The resulting table, from which all values of Ln between $L_{0.01}$ to $L_{99.99}$ can be calculated for each frequency band, is referred to as the spectral distribution table. Both the broadband and the spectral distribution tables are saved whenever an overall measurement is saved. As with the broadband distribution table, the SLM Utility-G3 software can export the spectral distribution table from a saved measurement to a spreadsheet which could then be utilized to calculate any possible value of Ln for the range $L_{0.01}$ to $L_{99.99}$ for all frequency bands.

Measurement History

When making automatic sequential measurements using the measurement history feature, and the spectral Ln mode has been enabled in the frequency spectrum setup, both the broadband and spectral distribution tables are saved for each measurement interval.

Exceedance Counters

See “Triggers Tab” on page 4-11

The Model 831 has three exceedance event counters: two RMS event counters and three peak event counters. For each exceedance there is a threshold level, event counter and duration.

The thresholds L_{XV} or $L_{Y_{\text{peak}}}$ are the levels that the parameter must exceed to increment the counter and duration. X is RMS frequency weighting, Y is peak frequency weighting and V is time weighting.

The Count is the number of times each parameter has exceed the preset level.

The duration is the total accumulated duration of all exceedances for a specific parameter.

Miscellaneous Parameters

S.E.A.

SEA is a time integration of peak levels that exceed 120 dB.

Time History (831-LOG Required)

See Chapter 11 “Time History” on page 11-1.

Measurement History (831-ELA Required)

See Chapter 12 “Measurement History” on page 12-1.

Event History (831-ELA Required)

See Chapter 13 “Event History” on page 13-1.

Memory Utilization

This chapter presents formulas you can use to calculate the amount of internal or USB memory required to store your measurement.

Out Of Memory Stop

In order to ensure that all measured data can be stored, the Model 831 stops automatically when the amount of available memory reaches 1 MB.

Overall Data

Each overall data block stored when performing a “Save File” operation utilizes memory as follows:

- **Without Spectral Ln enabled: 27 kB**
- **With Spectral Ln enabled: 307 kB**

Session Log

The amount of memory utilized in bytes when storing a session log is calculated as follows:

$$52 + 12 * (\text{Number of records})$$

Number of records includes the following:

- **Run**
- **Pause**
- **Stop**
- **Voice Message**
- **Markers**
- **Sound Recording.**

Measurement History

The amount of memory utilized in bytes when storing each measurement history block is calculated as follows:

- **Base Size: 4948**
- **Additional Noise Dose Data: 68**
- **Additional Weather Data: 128**
- **Additional Spectral Ln Data: 288000**
- **Additional GPS Data: 32**
- **Additional Takt Maximal: 4**

Time History

The amount of memory utilized, in bytes, when storing a time history block is calculated as follows:

$$52 + (\text{Number of records}) * [16 + 4 * (\text{Number of parameters enabled})]$$

where **Number of Records** = Number of Samples + Number of Run, Pause and Stop events

Events

The amount of memory utilized in bytes when storing each noise event block without event time history data is calculated as follows:

Basic Event Data

- **Base Size: 90**
- **With 1/1 Octave Spectra Data: 186**
- **With 1/3 Octave Spectra Data: 378**
- **With 1/1 and 1/3 Octave Spectra Data: 474**

Event Time History Data

The 1/3 octave spectra are measured when the spectral mode has been selected to be either 1/3 octave or 1/1,1/3 octave.

When event time history data is being saved, this increases the amount of memory utilized as follows:

- Without Spectral Data: $4 * (\text{Number of Samples}) + 20$
- With 1/1 Octave Spectra: $13 * 4 * (\text{Number of Samples}) + 20$
- With 1/3 Octave Spectra: $37 * 4 * (\text{Number of Samples}) + 20$

Voice Messages

The amount of memory utilized in bytes when storing each voice message is calculated as follows:

$$24 + 16000 * (\text{Record Length})$$

where **Record Length** is in seconds.

Sound Recording

The amount of memory utilized in bytes when storing each sound recording is calculated as follows:

$$72 + 2 * (\text{Sampling Rate}) * (\text{Record Length})$$

where:

- **Sampling Rate** is in Hz
- **Record Length** is in seconds.

Bad Flash Blocks

The Flash memory device used by the Model 831 contains a controller that performs dynamic bad block mapping. In the event that a Flash block fails after it has been written, that bad block may be detected by the Model 831 firmware. If a bad block is detected, the message shown in FIGURE 25-1 will be displayed.

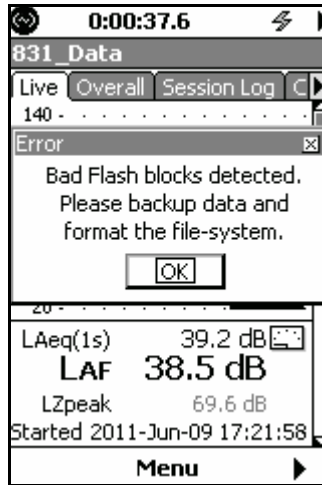

FIGURE 25-1 Bad Flash Blocks Detected

Data in a bad Flash block is usually unrecoverable. Files should be checked for errors if this message is displayed.

In this case data should be retrieved from the Model 831 and a file system format performed. Performing a file-system format forces the controller to re-map all bad blocks.

Upgrade Software, Firmware, and Options

This chapter describes the procedure for upgrading G4 LD Utility, Model 831 firmware, and firmware options.

Installing or Updating G4 LD Utility

In addition to data visualization, file utility functions, and remote operation of your Model 831, G4 LD Utility (G4) software is used to upgrade the firmware and firmware options. Upgrade to the latest version of G4 to

Step 1 To update to the most recent version of G4, go to:

<http://www.larsondavis.com/support/softwareproductssupport/slm-utility-g4>.

Step 2 From the **Software** section, select the appropriate version of G4 for your system.

Step 3 Download and install the software. G4 creates a shortcut icon on the Desktop and an item in the Start menu.



Upgrading Model 831 Firmware or Options

G4 enables you to easily upgrade your instrument firmware and install purchased firmware options. Since the latest version of G4 also contains the latest Model 831 firmware, upgrade your G4 before you continue.

Step 1 Update your G4 software to the latest version as shown in the previous section.

Step 2 Open G4, and navigate to **Help** → **Manuals** → **G4 LD Utility** → **Module 5 Upgrading Software, Firmware, and Options** for instructions on upgrading Model 831 firmware.

A

Technical Specifications

The specifications contained in this chapter are subject to change without notice. Please refer to calibration and measurement results for data on a specific unit.

Standards Met by Model 831

Sound Level Meter Standards

IEC61672-1 Ed. 2.0 (2013-09) Class 1, Group X

IEC60651 Ed 1.2 (2001) plus Amendment 1 (1993-02) and Amendment 2 (2000-10) Type 1, Group X

IEC60804 (2000-10) Type 1, Group X

ANSI S1.4-2014 Class 1

ANSI S1.4-1983 (R2006) plus Amendment ANSI S1.4A-1985 (R2006) Type 1

ANSI S1.43-1997 (R2007) Type 1

DIN 45657

Octave Filter Standards (Option 831- OB3)

IEC61260 Ed. 1.0 (1995-08) plus Amendment 1 (2001-09), 1/1 and 1/3-octave Bands, Class 1, Group X, all filters

ANSI S1.11-2004 (R2009) Class 1

Personal Noise Dosimeter Standards (Option 831-IH)

IEC61252 Ed. 1.1 (2002-03)

ANSI S1.25-1991(R2007)

Room Acoustics Standards (Option 831-RT)

ISO 3382-1:2009 Measurement of Room Acoustic Parameters Part 1: Performance Rooms

ISO 3382-2:2008 Measurement of Room Acoustic Parameters Part 2: Reverberation Time in Ordinary Rooms

ASTM E2235 (2004) Standard Test Method for Determination of Decay Rates for Use in Sound Insulation Test Methods.

Safety Requirements for Electrical Equip. for Measurement, Control, and Lab Use

IEC61010-1 Ed. 2.0 (2001-02)

Model 831 Specifications

Features

Table 1: Model 831 Features

Class 1 Precision Integrating Sound Level Meter with real-time 1/1 and 1/3 Octave Filters
2 GB standard data memory
High contrast 1/8th VGA LCD display with white LED backlight; readable in sunlight
Icon-driven graphic user interface
Soft rubber, backlit keys
Large dynamic range
Time weightings: Slow, Fast, Impulse, Integration and Peak simultaneously
Integration Method: Linear or Exponential (Slow, Fast, or Impulse)
Frequency weightings: A, C, Z simultaneously
1/1 and 1/3 octave frequency analysis available
Voice message annotation and sound recording available
L_n Statistics (L0.01 through L99.9 available)
1/1 or 1/3 Octave Spectral L_n Statistics available
831 Utility software available for setup, control and high speed data download with export to MS Excel™
Multi-tasking processor allows measuring while viewing data or transferring data
Data Secure Feature saves data to permanent memory every minute
Communication Options: RS-232, modem with Dial-up mode, or Ethernet with 831-INT-ET
AC/DC outputs
Long battery life; > 8 hours continuous measurement
Multiple Language Support
Field-upgradeable firmware: keeps instrument current with the latest measurement features
Two-year limited warranty

Sound Level Meter Specifications

Table 2: Sound Level Meter Specifications

RMS Time weighting	Slow, Fast, or Impulse
Frequency Weighting	A, C or Z
Peak Detector Frequency Weighting	A, C or Z
Reference range	0 dB Gain and Octave Band Analysis Normal Range
Exchange rates	3, 4, 5, or 6 dB with optional 831-IH
Sample rate	51,200 Hz
Peak rise time	30 μ s
Integration Method	Linear or Exponential

FFT Specifications

Table 3: FFT Specifications

Frequency Span	100 Hz - 20 kHz in a 1-2-5 sequence
FFT Lines	400, 800, 1600, 3200, or 6400
Windowing Functions	Hanning, Flat-Top, or Rectangular
Frequency Weighting	A, C, or Z
Zoom	Graphical
Units	dB re 20 μ Pa
Output	Magnitude

Performance Specifications

For performance specifications of the Model 831 with the PRM2103 preamplifier, see the *Larson Davis PRM2103 Outdoor Microphone Preamplifier Manual*.

Table 4: Model 831 Performance Specifications

		PRM831 with 377B02 Microphone		Direct Input	
Gain		0 dB	20 dB	0 dB	20 dB
Measurement Range ¹	A	(28 to 140 dB)	(24.9 to 120 dB)	N/A	N/A
	C	(29 to 140 dB)	(27 to 120 dB)	N/A	N/A
	Z	(35 to 140 dB)	(34 to 120 dB)	N/A	N/A
Noise Floor ¹	A	18 dB	17 dB	11.3 dB μ V	to 2.1 dB μ V
	C	18 dB	17 dB	12.5 dB μ V	to 2.4 dB μ V
	Z	23 dB	21 dB	18.9 dB μ V	to 3.1 dB μ V
Linearity Range ²	A	\geq 115 dB (24 to 140 dB)	\geq 101 dB (19 to 120 dB)	\geq 116 dB μ V (24 to 140 dB μ V)	\geq 112 dB μ V (9 to 121 dB μ V)
	C	\geq 114 dB (25to140 dB)	\geq 96 dB (23to120 dB)	\geq 118 dB μ V (22to140 dB μ V)	\geq 113 dB μ V (8 to 121 dB μ V)
	Z	\geq 106 dB (32 to 140 dB)	\geq 86 dB (32 to 120 dB)	\geq 113 dB μ V (27 to 140 dB μ V)	\geq 107 dB μ V (14 to 121 dB μ V)
Peak Range ²	A	(66 to 143 dB)	(46 to 123dB)	(76 to 143 dB μ V)	(56 to 124 dB μ V)
	C	(66 to 143 dB)	(46 to 123 dB)	(73 to 143 dB μ V)	(53 to 124 dB μ V)
	Z	(77 to 143 dB)	(59 to 123 dB)	(78 to 143 dB μ V)	(58 to 124 dB μ V)
SPL Max Level ²	140 dB	120 dB	140 dB μ V	121 dB μ V	
Peak Max Level ²	143 dB	123 dB	143 dB μ V	124 dB μ V	
Max Level Normal Octave Band Analysis (OBA) Range ²	140 dB	120 dB	140 dB μ V	120 dB μ V	
Max Level Low OBA Range ²	107 dB	87 dB	107 dB μ V	87 dB μ V	
1. Microphone and electrical self-noise included 2. Electrical Measurements					

The Octave Band Analysis specifications in the following tables were determined with an ADP090 equivalent microphone.

Table 5: Octave Band Analysis Performance Specifications

Nominal Frequency (Hz)		PRM831		Direct Input ²	
		0 dB Gain (dB re 20 µPa)	+20 dB Gain (dB re 20 µPa)	0 dB Gain (dB re 1 µV)	+20 dB Gain (dB re 1 µV)
Normal OBA Range, Linearity Range ¹	8.0	≥ 78 (62 to 140)	≥ 83 (37 to 120)	≥ 78 (62 to 140)	≥ 83 (37 to 120)
	16.0	≥ 85 (55 to 140)	≥ 88 (32 to 120)	≥ 85 (55 to 140)	≥ 88 (32 to 120)
	31.5	≥ 87 (53 to 140)	≥ 89 (31 to 120)	≥ 87 (53 to 140)	≥ 89 (31 to 120)
	63.0	≥ 92 (48 to 140)	≥ 90 (30 to 120)	≥ 92 (48 to 140)	≥ 90 (30 to 120)
	125.0	≥ 95 (45 to 140)	≥ 89 (31 to 120)	≥ 95 (45 to 140)	≥ 89 (31 to 120)
	250.0	≥ 94 (46 to 140)	≥ 92 (28 to 120)	≥ 94 (46 to 140)	≥ 92 (28 to 120)
	500.0	≥ 90 (50 to 140)	≥ 91 (29 to 120)	≥ 90 (50 to 140)	≥ 91 (29 to 120)
	1000.0	≥ 95 (45 to 140)	≥ 95 (25 to 120)	≥ 95 (45 to 140)	≥ 95 (25 to 120)
	2000.0	≥ 92 (48 to 140)	≥ 95 (25 to 120)	≥ 92 (48 to 140)	≥ 95 (25 to 120)
	4000.0	≥ 90 (50 to 140)	≥ 92 (28 to 120)	≥ 90 (50 to 140)	≥ 92 (28 to 120)
	8000.0	≥ 88 (52 to 140)	≥ 87 (33 to 120)	≥ 88 (52 to 140)	≥ 87 (33 to 120)
	16000.0	≥ 85 (55 to 140)	≥ 85 (35 to 120)	≥ 85 (55 to 140)	≥ 85 (35 to 120)

1. Electrical measurements, microphone noise not included.
2. Typical preamplifier noise included, direct-in electrical performance using CBL093 may be better than indicated at low frequencies

Table 5: Octave Band Analysis Performance Specifications (Continued)

Low OBA Range, Linearity Range¹	8.0	≥ 75 (32 to 107)	≥ 52 (35 to 87)	≥ 75 (32 to 107)	≥ 52 (35 to 87)
	16.0	≥ 78 (29 to 107)	≥ 59 (28 to 87)	≥ 78 (29 to 107)	≥ 59 (28 to 87)
	31.5	≥ 80 (27 to 107)	≥ 58 (29 to 87)	≥ 80 (27 to 107)	≥ 58 (29 to 87)
	63.0	≥ 81 (26 to 107)	≥ 60 (27 to 87)	≥ 81 (26 to 107)	≥ 60 (27 to 87)
	125.0	≥ 84 (23 to 107)	≥ 65 (22 to 87)	≥ 84 (23 to 107)	≥ 65 (22 to 87)
	250.0	≥ 90 (17 to 107)	≥ 70 (17 to 87)	≥ 90 (17 to 107)	≥ 70 (17 to 87)
	500.0	≥ 92 (15 to 107)	≥ 69 (18 to 87)	≥ 92 (15 to 107)	≥ 69 (18 to 87)
	1000.0	≥ 88 (19 to 107)	≥ 70 (17 to 87)	≥ 88 (19 to 107)	≥ 70 (17 to 87)
	2000.0	≥ 92 (15 to 107)	≥ 75 (12 to 87)	≥ 92 (15 to 107)	≥ 75 (12 to 87)
	4000.0	≥ 90 (17 to 107)	≥ 77 (10 to 87)	≥ 90 (17 to 107)	≥ 77 (10 to 87)
	8000.0	≥ 87 (20 to 107)	≥ 75 (12 to 87)	≥ 87 (20 to 107)	≥ 75 (12 to 87)
	16000.0	≥ 84 (23 to 107)	≥ 73 (14 to 87)	≥ 84 (23 to 107)	≥ 73 (14 to 87)

1. Electrical measurements, microphone noise not included.
2. Typical preamplifier noise included, direct-in electrical performance using CBL093 may be better than indicated at low frequencies.

Table 6: ADP074 ICP Adapter Performance Specifications

	Gain (0 dB)	Gain (20 dB)
SPL Max Level	135 dB μ V	116 dB μ V
Peak Max Level	138 dB μ V	119 dB μ V
Octave Band Analysis (OBA) Max Level, Normal range	135 dB μ V	116 dB μ V
OBA Max Level, Low Range	102 dB μ V	83 dB μ V
ICP Constant Current	2.2 \pm 0.2 mA	
ICP Open Circuit Voltage	32 to 36 VDC	

General Specifications

Table 7: Physical Characteristics

Length with microphone and preamplifier	11.35 inches	29.0 cm
Length, instrument body only	8.80 inches	22.4 cm
Width	2.80 inches	7.10 cm
Depth	1.60 inches	4.10 cm
Weight with batteries; no preamplifier or microphone	13.6 oz	390 g
Weight with batteries, preamplifier and microphone	1.2 lb	550 g

Table 8: General Specifications

Reference Level	114.0 dB SPL
Reference Level Range	Single Large Range for SLM Normal Range for Octave Band Analysis option
Reference Frequency	1000 Hz
Reference Direction	0° is perpendicular to the microphone diaphragm
Influence of Temperature	≤ ± 0.5 dB error between -10° C and 50° C
Storage Temperature	-20° C to 70° C
Influence of Humidity	≤ ± 0.5 dB error from 30% and 90% relative humidity at 40° C
Equivalent Microphone Impedance	12 pF for Larson Davis 1/2" microphone
Range Level Error (OBA option)	≤ ±0.1 dB relative to the reference range
Digital Display Update Rate	Once per second. First display indication is available 0.25 seconds after initiation of a measurement
Filename Requirements	Up to 12 characters long using letters "A" to "Z" and "a" to "z"; numbers "0" to "9"; symbols "." period, "-" dash and "_" underscore.
Effect of an extension cable (EXCXXX) on calibration	None (up to 200 feet)
Electrostatic Discharges	The instrument is not adversely affected by electrostatic discharges.

I/O Connector Specification

The 831 meter includes an I/O connector for peripherals and external power, or other external devices. For example:

- CBL143 and CBL151 cables: these cables permit the Model 831 to be powered from external 12 V batteries.
- CBL154 cable: used to obtain power from a battery when used with the 426A12
- 831-INT: integrates the Model 831 with outdoor microphone units (426A12 and PRM2100K) and weather transducers
- PRM2103, 426A12 and 2101K: Model 831 provides control signals to these outdoor microphone units when not used with 831-INT

I/O Connector Pinouts

The pinouts for the I/O Connector are as shown in Table 9: " Model 831 I/O Pinouts" on page A-9.

Table 9: Model 831 I/O Pinouts

Pin #	Description	Signal Type	
1	Ground, Digital, Power Supply	Ground	<p>Making your own cable:</p> <p>To enable the “Logic In, Logic Control Input” feature when making your own cable, pin 12 (Mains Power Status) must be driven by a resistance lower than about 20kΩ.</p> <p>To do this, connect a 10kΩ resistor from pin 12 to either pin 13 (+2.5V, to simulate running on Mains power) or to pin 1 or 5 (Ground, to indicate running on external battery power).</p> <p>Pin 4 needs to be driven high to assert the Logic In and pulled low to de-assert the input. It should not be left floating. Do this with a momentary push-button switch from pin 4 to pin 13 with a 10kΩ pull down resistor to ground (10kΩ from pin 4 to pin 1 or 5).</p>
2	Logic Out 1, Logic Control Output	Output, 0 to +2.7 V	
3	831 Activity	Output, 0 to +2.7 V	
4	Logic In, Logic Control Input	Input, 0 to +5 V	
5	Ground, Digital, Power Supply	Ground	
6, 7	Vext, External Power Input	Input, +10.8 to +30 V, 0.5 A auto-resetting PTC fuse	
8	SensorClk_L, LD 426A12 digital sensor clock	Output, open drain, +20 V max open and 50 mA max closed	
9	SensorDIO, LD 426A12 digital sensor data	Bi-directional, +2.7 to +5 V logic, open drain	
10	CalOn_H, LD 426A12 calibration signal on	Output, 0 to +2.7 V	
11	Ovld, LD 426A12 overload detection signal	Input, 0 to +5 V	
12	Mains Power Status; OK when +2.7 V	Input, 0 to +2.7 V	
13	+2.7 V to supply logic switches	Output, +2.7 V through 220 Ω	
14	WindSpeedIn, Pulse input for wind speed sensors	Input, +5 Vpp max	
15	Vwthr1, Analog to Digital Converter Input, Wind Direction	Input, 0 to +2.048 V, 100k Ω load, scale with series resistor	
16	Vwthr2, Analog to Digital Converter Input, Temperature		
17	Vwthr3, Analog to Digital Converter Input, Humidity		
18	Analog Ground, Signal ground for pins 15 through 17	Ground	

Resolution Specifications

Table 10: Resolution Specifications

Levels	0.1dB
Dose	0.01%
Elapsed time	0.1 second
Real time clock	1 second
Calendar	01 Jan 2005 - 31 Dec 2038

Frequency Weightings

Table 11: Frequency Weightings

Nominal Frequency	Exact Frequency	Z-Weight (Ideal)	A Weight (Ideal)	C Weight (Ideal)	Electrical Limits: Class 1	Microphone Limits: Class 1
6.3	6.31	0.0	-85.3	-21.3		
8.0	7.94	0.0	-77.8	-17.7		
10	10.00	0.0	-70.4	-14.3	+ 1.4, - 0.7	±1.5
12.5	12.59	0.0	-63.4	-11.2	+ 0.5, - 0.6	±1.3
16	15.85	0.0	-56.7	-8.5	+ 0.4, -0.5	±1.0
20	19.95	0.0	-50.5	-6.2	+ 0.3, -0.4	±0.5
25	25.12	0.0	-44.7	-4.4	±0.2	±0.5
31.5	31.62	0.0	-39.4	-3.0	±0.2	±0.5
40	39.81	0.0	-34.6	-2.0	±0.2	±0.5
50	50.12	0.0	-30.2	-1.3	±0.5	±0.5
63	63.10	0.0	-26.2	-0.8	±0.5	±0.5
80	79.43	0.0	-22.5	-0.5	±0.5	±0.5
100	100.00	0.0	-19.1	-0.3	±0.5	±0.5
125	125.00	0.0	-16.1	-0.2	±0.5	±0.5
160	158.50	0.0	-13.4	-0.1	±0.2	±0.5
200	199.50	0.0	-10.9	0.0	±0.2	±0.5
250	251.20	0.0	-8.6	0.0	±0.2	±0.5

Table 11: Frequency Weightings (Continued)

Nominal Frequency	Exact Frequency	Z-Weight (Ideal)	A Weight (Ideal)	C Weight (Ideal)	Electrical Limits: Class 1	Microphone Limits: Class 1
315	316.20	0.0	-6.6	0.0	±0.2	±0.5
400	398.10	0.0	-4.8	0.0	±0.2	±0.5
500	501.20	0.0	-3.2	0.0	±0.2	±0.5
630	631.00	0.0	-1.9	0.0	±0.2	±0.5
800	794.30	0.0	-0.8	0.0	±0.2	±0.5
1000	1000.00	0.0	0.0	0.0	±0.2	±0.5
1250	1259.00	0.0	0.6	0.0	±0.2	±0.5
1600	1585.00	0.0	1.0	-0.1	±0.2	±0.5
2000	1995.00	0.0	1.2	-0.2	±0.2	±0.5
2500	2512.00	0.0	1.3	-0.3	±0.2	±0.5
3150	3162.00	0.0	1.2	-0.5	±0.2	±0.5
4000	3981.00	0.0	1.0	-0.8	±0.2	±0.5
5000	5012.00	0.0	0.5	-1.3	±0.2	± 0.75
6300	6310.00	0.0	-0.1	-2.0	±0.2	±1.0
8000	7943.00	0.0	-1.1	-3.0	±0.2	±1.0
10000	10000.00	0.0	-2.5	-4.4	±0.2	±1.0
12500	12590.00	0.0	-4.3	-6.2	±0.2	±1.5
16000	15850.00	0.0	-6.6	-8.5	±0.3	±2.0
20000	19950.00	0.0	-9.3	-11.2	±0.5	±2.0

Typical Z-Weight Frequency Response

For frequency responses of the Model 831 with the PRM2103 preamplifier, see the *Larson Davis PRM2103 Outdoor Microphone Preamplifier Manual*.

FIGURE A-1 High Pass Frequency Response

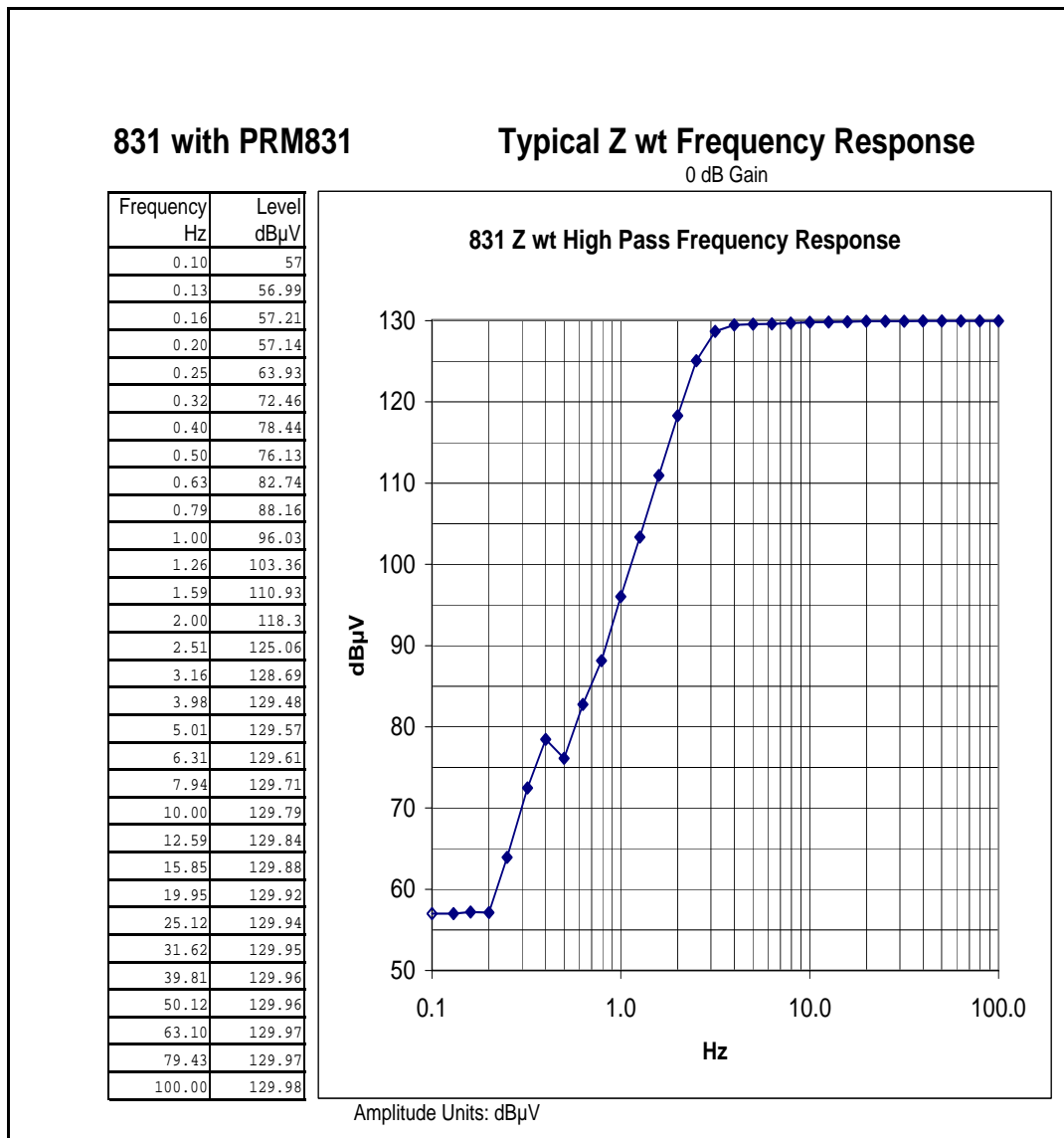

FIGURE A-2 Low Pass Frequency Response

831 with PRM831

Typical Z wt Frequency Response

0 dB Gain

Frequency Hz	Level dB μ V
1000	129.99
1259	130.00
1585	130.00
1995	130.01
2512	130.01
3162	130.02
3981	130.02
5012	130.02
6310	130.03
7943	130.03
10000	130.03
12589	130.01
15849	129.93
19953	129.67
21544	129.51
23263	128.63
25119	124.77
27123	113.81
29286	83.73
31623	63.62
34145	70.14
36869	71.18
39811	73.65
42987	73.30
46416	66.57
50119	67.04
54117	72.08
58434	73.93
63096	59.09
68129	74.58
73564	75.80
79433	76.23
85770	73.94
92612	72.14
100000	76.57

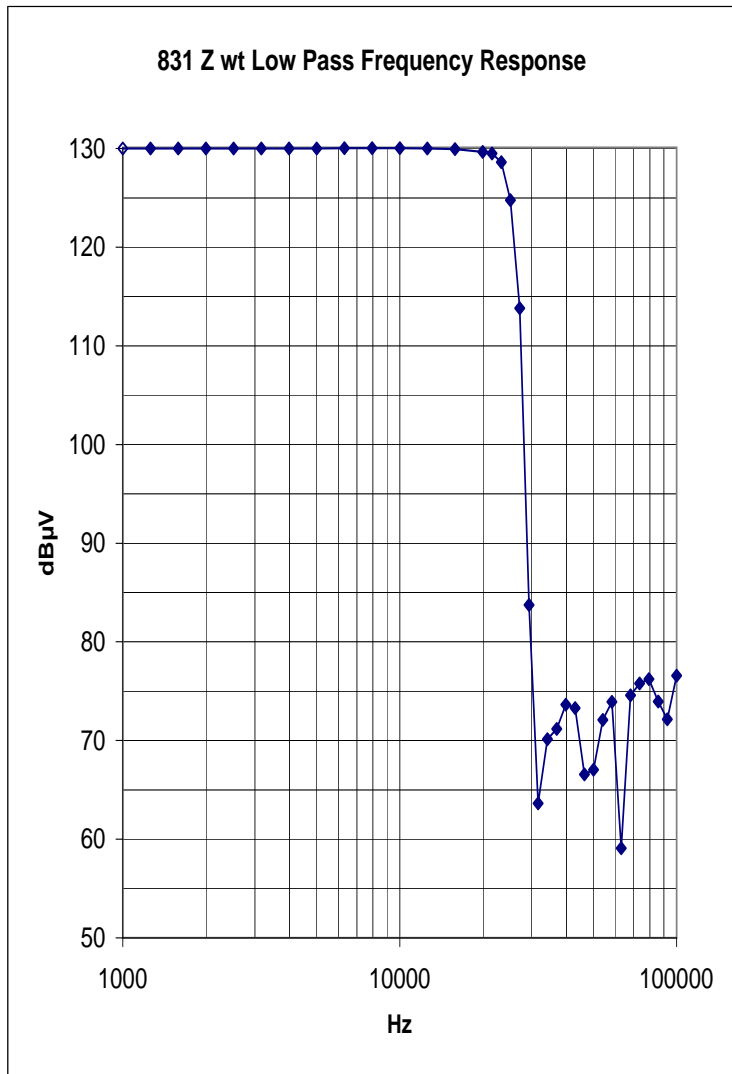

Amplitude Units: dB μ V

AC/DC Output

The purpose of the AC output is to drive a headset to listen to live and recorded sounds. It may be used for other purposes, but may not function as expected as a source for additional analysis equipment. The output is amplified for listening purposes and therefore is limited in its maximum output to be less than the instrument's maximum input level. For connection to external analysis equipment use the adapter ADP015 and cable EXC006 to extract the signal directly from the preamplifier output. When using the PRM831 preamplifier, there will be a DC bias on the output of the BNC connector of the ADP015 of approximately + 17 Volts.

Table 12: AC/DC Output

AC/DC Output Connector	2.5 mm Sub-Miniature Phone Jack Tip: DC Output Ring: AC Output Sleeve: Ground
AC Output Voltage Range	± 2.3V peak maximum output 0.5 mV to 1.6 Vrms sine wave ~70 dB dynamic range
AC Output Gain (relative to instrument input)	+ 19.2 dB
AC Output Frequency Weighting	Signal is unweighted with frequency limitations imposed by hardware design (see below)
AC Output Frequency Response	20 Hz to 23.6 kHz (-3 dB), RL= 10 kΩ 21 Hz to 23.6 kHz (-3 dB), RL= 600 Ω 95 Hz to 23.6 kHz (-3 dB), RL= 16 Ω
AC Output Recommended Loads	Headset with 16 Ω or greater speaker impedance Resistive loads greater than 600 Ω for maximum frequency response range.
AC Output Impedance	Low impedance headset speaker driver with 100 μF coupling capacitor. $Z = 1.5 + 1592/f$, where Z is output impedance in Ω (Ohms) and f is frequency in Hz. Instrument readings are not affected by AC output loading although a short circuit when there is a large signal output may draw excessive power such that the instrument could power off.
AC Output Phase and Delay	- 180° relative to input, 128 μs digital delay
DC Output Frequency Weighting	Follows the SLM Frequency Weighting: A, C or Z
DC Output Time Weighting	Follows the SLM Detector: F, S or I

Table 12: AC/DC Output (Continued)

DC Output Voltage Range	0 to +3 Volt (0 to 300 dB) $V_0 = \text{SPL}/100$ $\text{SPL} = 100 * V_0$ or Sensitivity = 0.01 V/dB with resolution of 0.001 V
DC Output Impedance	3650 Ω
DC Output Recommended Loads	$\geq 1 \text{ M}\Omega$ for less than 0.4% error A 10 $\text{M}\Omega$ DC Voltmeter represents negligible error (-0.036%). The output resistance can be accounted for in the interface design. For example, if a chart recorder has an input load of 10 $\text{k}\Omega$, the gain can be set to 1.365 to correct for the loading.

Min/Max Integration Time

Minimum and maximum integration time for measurement of time-average levels and sound exposure levels.

Table 13: Min/Max Integration Time

	Time Average Levels and Sound Exposure Levels, (s)
Minimum	0.1
Maximum (Daily Autostore enabled)	Unlimited
Maximum (Daily Autostore disabled, errors less than 0.5 dB)	> 23 days
	Dosimeter Metrics: TWA, Dose(s)
Minimum	0.1
Maximum	Unlimited

Time of Day Drift

The Model 831 displays the time of day and also time-stamps various single events (i.e. maximum level) and records.

Time-of-day clock accuracy is shown in Table 13: (applies only to instruments serial number 2089 and above with firmware version 1.600 or above).

Table 14: Time of Day Drift

Temperature	Drift per Day (seconds)	Drift per Month (seconds)	Drift per Year (minutes)	ppm
25° C	< ±1	< ±8	< ± 2	2.0
-10 to +50° C	< ±1	< ±8	< ± 2	2.8
-40 to +70° C	< ±1	< ±10	< ± 2	3.5

Time Variations Between Session Log and Overall Start Time

The Session Log and the Run/Stop record in the Time History contain the time when the  RUN/PAUSE button was pressed. The Overall display shows the time when logging begins. Since it takes some time before data is available to be logged after starting to run, there can be a small difference between these times.

This discrepancy can show up on the Model 831 where time resolution is in seconds. An example of would be when the  (RUN/PAUSE) button is pressed a moment before the seconds digit transitions. Data to be logged is available a moment later but the Seconds digit has changed. In this situation the difference will appear to be a full second. In actuality the difference is closer to 1/10 of a second.

Power Supply

Table 15: Power Supply Specifications

Batteries	4-AA (LR6) NiMH, Alkaline or Energizer L91 e ² ® Lithium cells (supplied with 2500 mAH NiMH cells). Warning: Use of battery cells with greater than 1.5 Volt specified rating can damage the instrument and void the warranty.
External Power	Powered through USB interface from computer or from PSA029 AC to DC Power Adapter: 5 Volt ± 5% required. Applying a voltage greater than specified can damage the instrument and void the warranty.
External Power	Power through I/O connector: 10 to 15.5 Vdc. Use cable CBL154 for 426A12, CBL140 for PSA027, or Model 831-INT Interface Unit

Battery Operating Lifetime

Table 16: Battery Operating Lifetime

Battery	Operating Life, Hours
4-AA (LR6) NiMH Cells	> 8

Power Consumption

Table 17: Power Consumption

Model 831 Operating State	Watts	mA @ 12 Volts	mA @ 15 Volts
Running, Backlight Off, USB not connected	1.1	95	76
Running, Backlight Off, USB connected to PC	1.7	142	114
Running, Backlight Bright, USB connected to PC	2.9	238	190

Memory Retention

Table 18: Memory Retention Without Batteries or External Power

Data Memory	Permanently stored in non-volatile flash memory every one minute. If power failure, maximum data loss will be less than one minute
Real-time Clock	≥ 10 minutes

PSA029 AC to DC USB Power Adapter Specifications

Table 19: PSA029 AC to DC USB Power Adapter Specifications

DC Output Voltage	5 Volts
DC Output Regulation	Line: ± 5% Load: ± 5%
DC Output Load	Minimum: 0 A Maximum: 0.5 A
DC Output Connector	USB Type A Jack (USB Cable, type A to mini-B supplied)
AC Input Voltage	90 to 264 Vac
AC Input Frequency	47 to 63 Hz
AC Input Current	0.15 Arms, 120 Vac at maximum load 0.08 Arms, 230 Vac at maximum load
Ac Inrush Current	30 A for 120 Vac at maximum load 60 A for 240 Vac at maximum load

Table 19: PSA029 AC to DC USB Power Adapter Specifications (Continued)

Efficiency	55% typical
Power Saving	0.3 W maximum, no load, 230 Vac, 50 Hz
Temperature	Operation: 0 to 45° C Storage: - 40° C to + 85° C
Humidity	Operation: 10% to 90% Storage: 5% to 85%
Safety Approvals	cUL/UL, CE, TEV, C-Tick and SAA
Emissions	FCC Part 15 Class B EN55022 Class B
Immunity	EN61000-4-2, Level 4 EN61000-4-3, Level 2 EN61000-4-4, Level 2 EN61000-4-5, Level 3 EN61000-4-6, Level 3 EN61000-4-11
Harmonic	EN6100-3-2 (A1 +A2 + A14)
Flicker	EN6100-3-3
Leakage Current	0.20 μ A maximum 254 Vac, 54 Hz
Dielectric Withstand (Hipot)	3,000 Vac, 1 minute, 10 mA
MTBF (Full Load, 25° C)	> 150 kHrs.
AC Input Plugs (supplied)	USA: RPA Europe: RPE UK: RPK Australia: RPS
Dimensions/Weight	Length: 75.32 mm (2.97 in) Height: 31.67 mm (1.25 in) Width: 45.96 mm (1.81 in) Weight: 61.1 g (2.16 oz)

CE Information

Declaration of Conformity



PCB Piezotronics, Inc. declares that: Model 831 Sound Level Meter

has been measured in representative configuration with: PRM831 preamplifier, 377B02 microphone

and the following cables: EXC010 microphone extension cable, CBL138 USB interface cable and CBL139 AC/DC output cable with an applied acoustic field of 74 dB at 1 kHz.

The Model 831 SLM complies with the European Community EMC Directive (2004/108/EC) and also the Low Voltage Safety Directive (2006/95/EC) by meeting the following standards:

- IEC61326-1:2005: Electrical equipment for measurement, control and laboratory use - EMC requirements.
- IEC61000-4-2:2008 Electrostatic discharge (ESD) immunity. ± 4 kV contact discharges and ± 8 kV air discharges.
- IEC61000-4-3:2006 Radiated, radio frequency, electromagnetic field immunity. 26 MHz to 1 GHz at 10 V/m, 1.4 GHz to 2 GHz at 3 V/m, 2.0 GHz to 2.7 GHz at 1 V/m with 1 kHz 80% AM.
- IEC61000-4-4:2004 Electrical fast transient (EFT)/burst immunity. ± 2 kV (5/50 ns, 5 kHz).
- IEC61000-4-6:2008 Immunity to RF conducted line disturbances. 10 V, 1 kHz 80% AM from 150 kHz to 80 MHz.
- IEC61000-4-8:2001 Power frequency magnetic field immunity. 80 A/m. 50/60 Hz.
- CISPR 11:2009: Industrial, scientific and medical (ISM) radio-frequency equipment - Electromagnetic disturbance characteristics - Limits and methods of measurement Class B
- IEC61010-1:2001 Safety requirements for electrical equipment for measurement, control and laboratory use - Part 1: General Requirements.

1/1 and 1/3 Octave Filters

The 1/1 and 1/3 octave filters (Option 831-OB3) comply with all requirements of IEC 61260 Ed 1.0 (1995-08) including amendment 1 (2001-09) for Class 1 and all requirements of ANSI S1.11-2004 and ANSI S1.11-1 for Class 1. These digital filters are sampled at a rate of 51,200 samples per second, with base X10 center frequencies and having real-time performance for all filters. The 0 dB gain setting is the reference range and the reference input signal is 1 Volt rms at 1 kHz.

When testing filters, an ADP092 adaptor should be used. If this is not available, a 2-pole filter with cutoff frequency of 75 kHz can be used as an alternative.

Frequency Range

1/1 Octave Filters: 8 Hz to 16 kHz

1/3 Octave Filters: 6.3 Hz to 20 kHz

1/1 Octave Filter Linearity

The filter linearity range depends upon both the Input Gain, which is set as described in the section "20 dB Gain" on page 4-5, and the Filter Range, which is set as described in the section "OBA Range Setting" on page 4-7. The data was measured using an electrical input. Results are in dB re. 1 μ V, which is equivalent to dB SPL when a 50 mV/Pa microphone is used.

Table 20: 1/1 Octave Linearity Range

Gain Range	0 dB				0 dB				20 dB				20 dB			
	Normal				Low				Normal				Low			
Frequency	Overload	Linearity Range	Lower Linearity Limit	Noise Floor	Overload	Linearity Range	Lower Linearity Limit	Noise Floor	Overload	Linearity Range	Lower Linearity Limit	Noise Floor	Overload	Linearity Range	Lower Linearity Limit	Noise Floor
8.0	140.8	78.9	61.9	31.9	107.5	75.5	32.0	14.1	120.7	83.7	37.0	16.2	87.4	52.4	35.0	13.7
16.0	140.8	85.8	55.0	31.9	107.5	78.7	28.8	12.8	120.7	88.7	32.0	14.7	87.4	59.4	28.0	10.0
31.5	140.8	87.8	53.0	30.4	107.5	80.5	27.0	8.8	120.7	89.7	31.0	14.3	87.4	58.4	29.0	9.0
63.0	140.8	92.8	48.0	29.5	107.5	81.5	26.0	6.2	120.7	90.7	30.0	12.9	87.4	60.4	27.0	5.8
125.0	140.8	95.8	45.0	31.1	107.5	84.5	23.0	4.4	120.7	89.7	31.0	12.6	87.4	65.4	22.0	4.1
250.0	140.8	94.8	46.0	31.1	107.5	90.5	17.0	2.2	120.7	92.7	28.0	11.2	87.4	70.4	17.0	2.8
500.0	140.8	90.8	50.0	33.5	107.5	92.5	15.0	2.1	120.7	91.7	29.0	12.1	87.4	69.4	18.0	2.0
1000.0	140.8	95.7	45.1	31.7	107.5	88.5	19.0	2.0	120.7	95.7	25.0	12.0	87.4	70.4	17.0	0.2
2000.0	140.8	92.7	48.1	33.6	107.5	92.5	15.0	2.5	120.7	95.6	25.1	13.8	87.4	75.4	12.0	-2.9
4000.0	140.8	90.8	50.0	36.7	107.5	90.5	17.0	5.1	120.7	92.6	28.1	16.7	87.4	77.4	10.0	-2.3
8000.0	140.8	88.8	52.0	40.3	107.5	87.5	20.0	8.3	120.7	87.7	33.0	20.2	87.4	75.4	12.0	-0.4
16000.0	140.8	85.8	55.0	43.6	107.5	84.5	23.0	11.5	120.7	85.7	35.0	23.5	87.4	73.4	14.0	2.0

1/1 Octave Filter Summation Error

The Octave Filter Summation Error shown in the following graphs is defined by IEC61260 4.9.

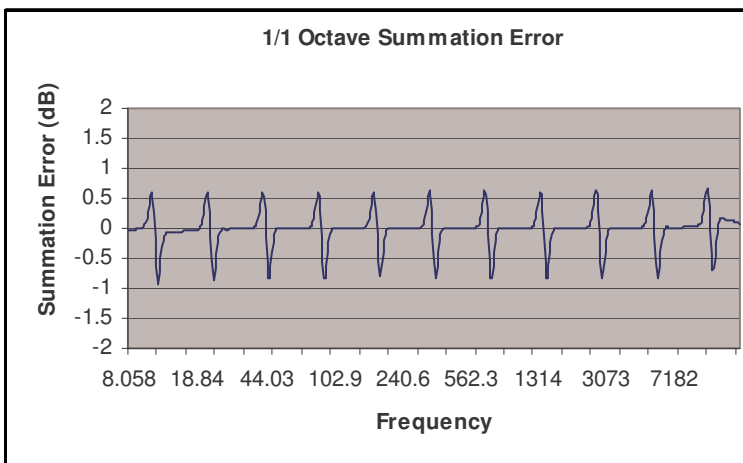

FIGURE A-4 Gain = 0 dB, Filter Range = Normal

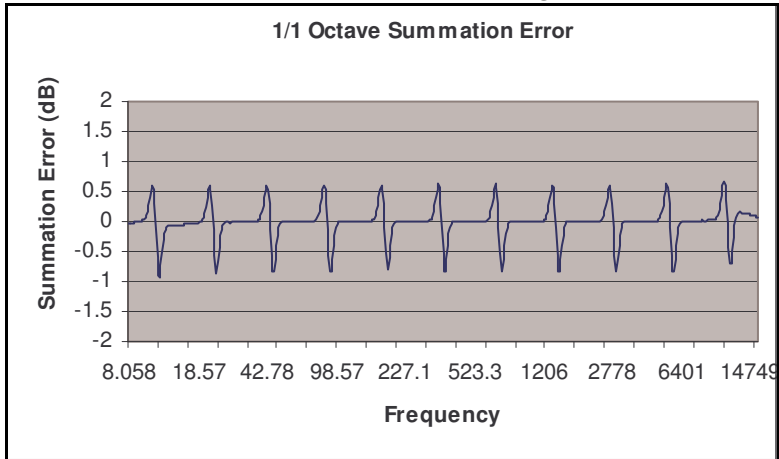

FIGURE A-5 Gain = 0 dB, Filter Range = Low

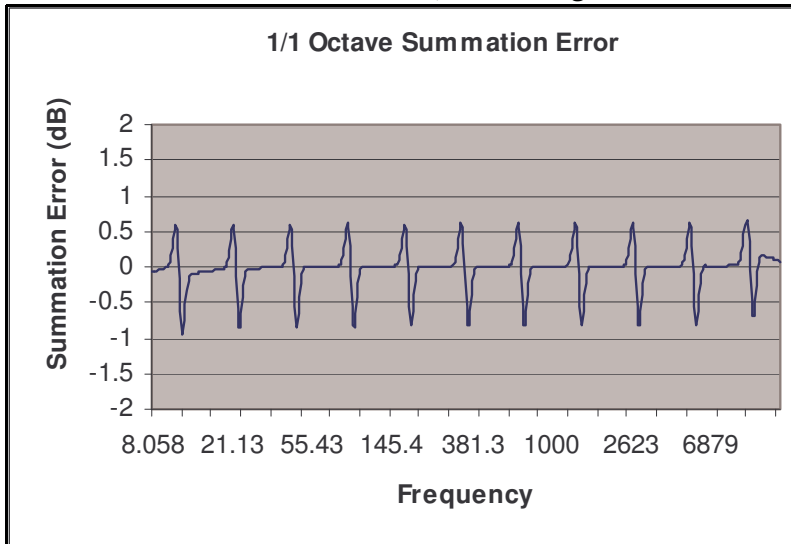

FIGURE A-6 Gain = 20 dB, Filter Range = Normal

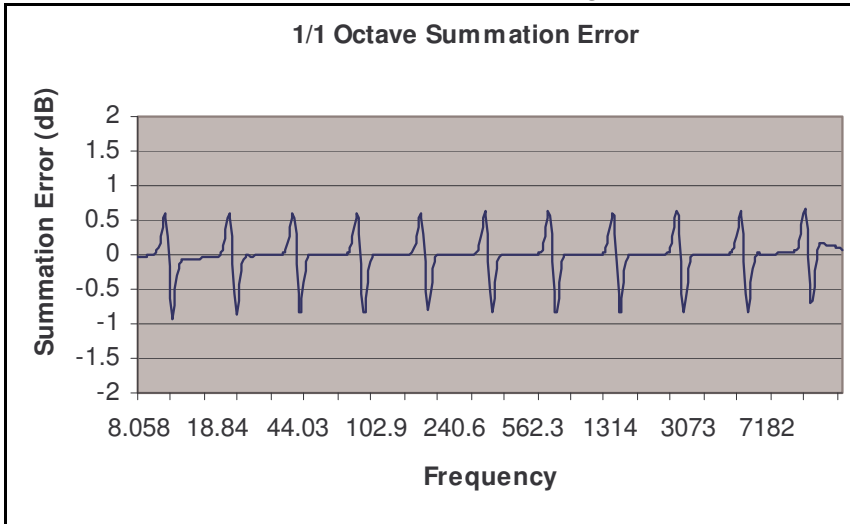
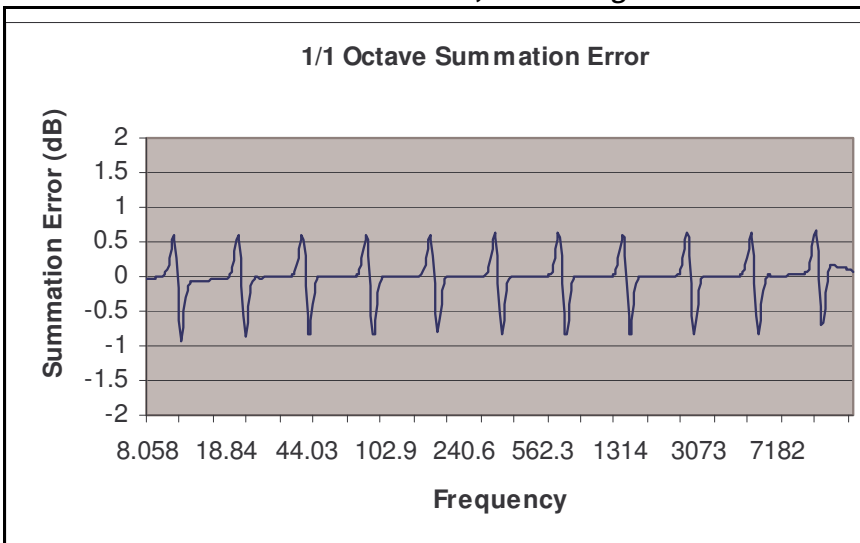

FIGURE A-7 Gain = 20 dB, Filter Range = Low



1/3 Octave Filter Linearity

The filter linearity range depends upon both the Input Gain, which is set as described in the section "20 dB Gain" on page 4-5, and the Filter Range, which is set as described in the section "OBA Range Setting" on page 4-7. The data, measured using an electrical input, are in dB re. 1 μ V, which is equivalent to dB SPL when a 50 mV/Pa microphone is used. See "**1/3 Octave Linearity Range**" on **page A-25**.

Table 21: 1/3 Octave Linearity Range

SPL Range	0 dB				0 dB				20 dB				20 dB			
	Normal	Linearly	Lower Linearity	Noise Floor	Normal	Linearly	Lower Linearity	Noise Floor	Normal	Linearly	Lower Linearity	Noise Floor	Normal	Linearly	Lower Linearity	Noise Floor
6.3	140.8	88.1	52.0	27.6	107.5	71.5	36.0	12.3	120.7	81.7	39.0	13.5	87.0	53.0	34.0	9.9
8	140.8	91.8	46.0	26.7	107.5	74.6	33.0	9.6	120.7	87.7	33.0	12.2	87.0	47.0	40.0	6.6
10	140.8	92.8	48.0	28.4	107.5	78.2	29.0	8.3	120.7	87.7	33.0	11.3	87.0	56.0	29.0	6.3
12.5	140.8	91.8	49.0	28.2	107.5	72.9	31.6	8.8	120.7	89.7	31.0	9.1	87.0	59.0	25.0	7.3
16	140.8	91.8	49.0	29.5	107.5	78.7	30.8	6.9	120.7	88.7	32.0	10.6	87.0	60.0	21.0	6.8
20	140.8	92.8	48.0	27.7	107.5	76.7	28.8	6.0	120.7	90.7	30.0	9.8	87.0	59.0	28.0	3.6
25	140.8	94.8	46.0	25.7	107.5	81.5	26.0	5.5	120.7	87.7	33.0	8.8	87.0	60.0	27.0	3.9
31.5	140.8	93.8	47.0	26.5	107.5	85.5	22.0	5.3	120.7	90.7	30.0	8.4	87.0	64.0	23.0	4.1
40	140.8	93.8	45.0	25.2	107.5	88.5	21.0	3.6	120.7	92.7	28.0	8.1	87.0	63.0	24.0	2.6
50	140.8	95.8	41.0	27.7	107.5	86.5	21.0	1.5	120.7	92.7	28.0	7.7	87.0	66.0	21.0	2.5
63	140.8	97.8	43.0	25.7	107.5	87.5	20.0	1.5	120.7	95.7	25.0	8.4	87.0	67.0	20.0	2.9
80	140.8	98.8	42.0	25.8	107.5	83.5	24.0	1.2	120.7	93.7	27.0	7.5	87.0	71.0	16.0	2.7
100	140.8	97.8	43.0	25.6	107.5	84.5	23.0	0.5	120.7	96.7	24.0	7.6	87.0	69.0	18.0	2.3
125	140.8	96.8	44.0	24.6	107.5	87.5	20.0	-1.4	120.7	94.7	26.0	6.2	87.0	71.0	16.0	-0.3
160	140.8	100.8	40.0	25.2	107.5	88.5	19.0	-1.8	120.7	95.7	25.0	4.4	87.0	73.0	14.0	-2.4
200	140.8	99.8	41.0	25.6	107.5	87.5	20.0	-1.8	120.7	99.7	21.0	5.8	87.0	71.0	16.0	-1.5
250	140.8	99.8	41.0	27.7	107.5	93.5	14.0	-3.0	120.7	98.7	22.0	4.8	87.0	75.0	12.0	-3.0
315	140.8	101.8	39.0	26.5	107.5	96.5	11.0	-2.5	120.7	99.7	21.0	5.6	87.0	74.0	13.0	-3.1
400	140.8	97.8	43.0	26.0	107.5	95.5	12.0	-2.0	120.7	96.7	24.0	8.1	87.0	75.0	12.0	-3.6
500	140.8	98.8	42.0	25.9	107.5	89.5	18.0	-2.1	120.7	92.7	28.0	5.6	87.0	79.0	8.0	-3.1
630	140.8	101.7	39.1	25.8	107.5	96.5	11.0	-2.3	120.7	100.7	20.0	6.0	87.0	80.0	6.0	-4.2
800	140.8	100.7	40.1	26.5	107.5	94.5	13.0	-3.0	120.7	99.7	21.0	6.1	87.0	81.0	6.0	-4.1
1000	140.8	97.8	43.0	26.9	107.5	96.5	12.0	-3.1	120.7	100.7	20.0	6.4	87.0	81.0	6.0	-4.9
1250	140.8	98.8	41.0	27.8	107.5	97.5	10.0	-2.9	120.7	100.7	20.0	7.6	87.0	79.0	8.0	-6.6
1600	140.8	100.8	40.0	28.3	107.5	97.5	11.0	-2.6	120.7	100.7	20.0	8.0	87.0	82.0	5.0	-7.4
2000	140.8	100.8	40.0	29.8	107.5	98.5	10.0	-2.1	120.7	100.7	20.0	8.7	87.0	82.0	5.0	-7.7
2500	140.8	99.8	41.0	29.8	107.5	98.5	11.0	-1.6	120.7	99.7	21.0	9.6	87.0	82.0	6.0	-7.6
3150	140.8	96.8	44.0	30.9	107.5	93.5	13.0	-0.4	120.7	99.7	22.0	10.6	87.0	81.0	6.0	-7.8
4000	140.8	97.7	43.1	31.9	107.5	94.5	13.0	0.4	120.7	97.7	23.0	11.6	87.0	82.0	5.0	-7.0
5000	140.8	96.8	45.1	33.1	107.5	92.8	15.0	1.4	120.7	96.7	24.0	13.0	87.0	82.0	3.0	-8.3
6300	140.8	93.8	47.0	33.9	107.5	93.8	14.0	2.4	120.7	94.7	26.0	14.1	87.0	81.0	6.0	-8.1
8000	140.8	91.8	49.0	35.5	107.5	91.5	16.0	3.5	120.7	92.7	28.0	15.0	87.0	80.0	7.0	-8.2
10000	140.8	92.7	48.1	36.6	107.5	90.5	17.0	4.5	120.7	93.7	27.0	16.4	87.0	79.0	8.0	-4.5
12500	140.8	91.7	49.1	37.6	107.5	89.5	18.0	5.8	120.7	91.7	29.0	17.5	87.0	79.0	9.0	-3.6
16000	140.8	90.8	50.0	38.6	107.5	88.5	18.0	6.5	120.7	91.7	29.0	18.5	87.0	78.0	8.0	-2.9
20000	140.8	88.8	52.0	40.2	107.5	87.7	19.8	8.2	120.7	89.7	31.0	20.2	87.0	77.0	10.0	-1.6

1/3 Octave Filter Summation Error

The Octave Filter Summation Error shown in the following graphs is defined by IEC61260 4.9.

FIGURE A-8 Gain = 0 dB, Filter Range = Normal

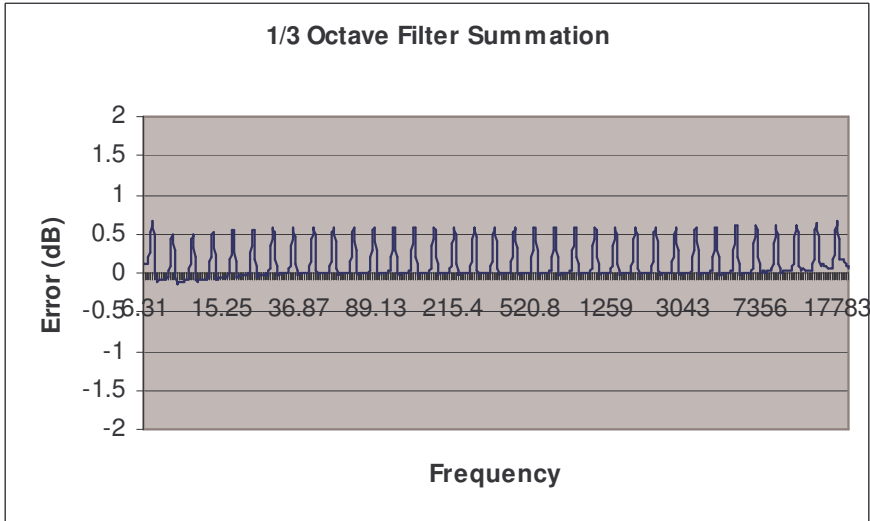

FIGURE A-9 Gain = 0 dB, Filter Range = Low

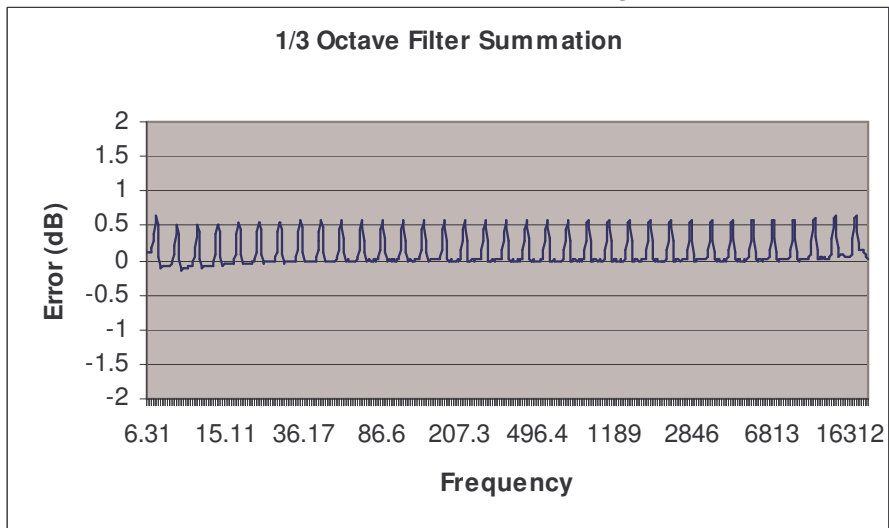

FIGURE A-10 Gain = 20 dB, Filter Range = Normal

1/3 Octave Filter Summation

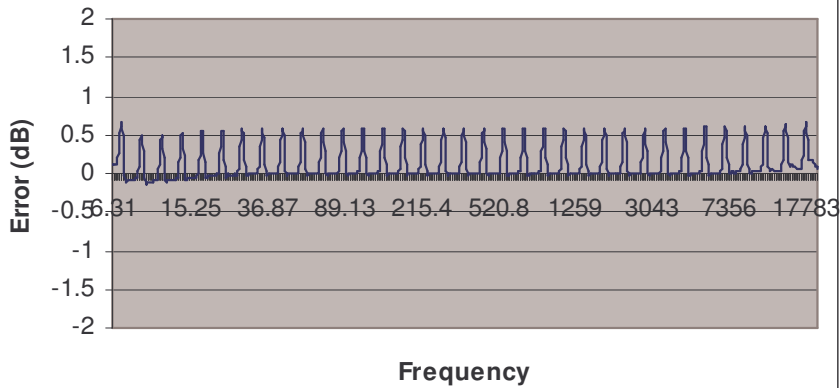
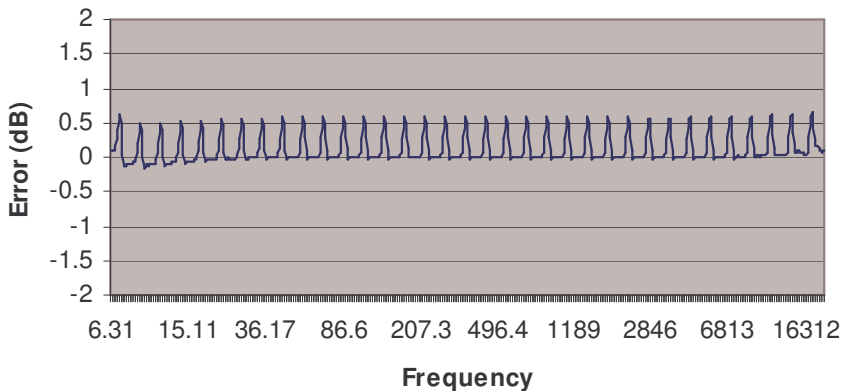

FIGURE A-11 Gain = 20 dB, Filter Range = Low

1/3 Octave Filter Summation



Minimum Residual Filter Decay Time for RT 60 (Firmware Opt 831-RT)

Table 21 on page A-25 shows the residual decay time (TR) and the bandwidth-time product (BT) for each of the filters on the Model 831. This data was taken by feeding the output of the internal pink noise source into the input of the Model 831 using a CBL09x. The residual decay time for each frequency is the T30 of the ensemble average of 50 decays.

Table 22: Residual Decay Times

Frequency	1/3 Octave		1/1 Octave	
	TR (ms)	BT	TR (ms)	BT
50.0 Hz	378	4.37		
63.0 Hz	301	4.38	160	7.12
80.0 Hz	216	3.96		
100 Hz	181	4.18		
125 Hz	153	4.43	86	7.63
160 Hz	119	4.34		
200 Hz	94	4.32		
250 Hz	75	4.36	40	7.10
315 Hz	55	4.04		
400 Hz	43	3.93		
500 Hz	37	4.26	16	5.62
630 Hz	29	4.18		
800 Hz	24	4.44		
1000 Hz	13	3.11	8	5.56
1250 Hz	17	4.97		
1600 Hz	16	5.85		
2000 Hz	12	5.38	6	8.87
2500 Hz	11	6.30		
3150 Hz	11	6.30		
4000 Hz	10	9.45	5	13.63
5000 Hz	8	9.42		
6300 Hz	5	7.27		
800 Hz	10	18.69	5	28.50
10000 Hz	7	17.05		

Pink Noise Generator Levels

Pink Noise Generator Levels are pseudo-random, uncorrelated, and produced by digital algorithm.

Position of Instrument and Operator

When making a measurement, it is recommended that the observer be positioned as far behind and to the right of the instrument as possible to minimize interference of the sound field at the microphone resulting from body reflections. When using the Model 831, the meter is held in one hand with the arm extended away from the body. Better results can be obtained by using a tripod.

Effect of Windscreen

The corrections which should be subtracted from the measured data when using the Larson-Davis Model WS001 3½ inch diameter windscreen with a ½ inch Larson-Davis microphone are as indicated in the following table.

Table 23: Directional Response of 3.5-inch Windscreen

Directional Response Effect of 3½ Inch Wind Screen on 377B02 Microphone Attached to Model 831													
Frequency (Hz)	Angle from Reference direction (degrees)												
	0	15	30	45	60	75	90	105	120	135	150	165	180
251.19	0.00	0.00	0.00	0.00	0.00	0.00	0.00	0.00	0.00	0.00	0.00	0.00	0.00
266.07	0.00	0.00	0.03	-0.03	0.00	0.00	0.00	-0.03	0.03	0.00	-0.03	-0.03	0.00
281.84	0.00	0.10	0.07	-0.03	-0.07	0.00	0.03	0.00	0.07	0.00	-0.03	-0.03	0.00
298.54	0.07	0.07	0.00	0.00	-0.03	0.00	0.03	-0.03	-0.03	0.03	-0.10	0.03	0.00
316.23	0.00	0.03	0.07	0.00	-0.07	-0.03	0.00	-0.03	0.03	-0.03	-0.10	0.07	0.00
334.97	0.00	0.00	0.03	0.00	-0.07	-0.03	0.07	-0.13	0.00	0.00	-0.07	0.07	0.00
354.81	0.03	0.07	0.10	-0.03	-0.07	0.00	0.00	-0.03	0.03	0.03	-0.03	0.03	0.00
375.84	0.03	0.07	0.03	0.00	-0.03	-0.03	0.00	-0.03	0.03	0.00	-0.10	0.00	0.00
398.11	0.00	0.00	0.10	-0.03	-0.03	0.00	0.00	-0.03	0.07	-0.03	-0.07	0.07	0.07
421.70	0.00	0.00	0.07	0.03	-0.07	-0.03	0.00	-0.03	0.03	0.00	-0.07	0.00	0.00
446.68	0.00	0.03	0.03	-0.03	0.00	-0.03	0.10	0.03	0.03	0.00	0.00	0.00	0.00
473.15	0.03	0.03	0.03	0.00	0.03	-0.03	0.07	0.00	0.03	0.00	-0.07	0.03	0.00
501.19	0.10	0.10	0.13	0.07	-0.03	0.07	0.00	0.00	0.13	0.10	-0.07	0.03	0.00
530.88	0.03	0.10	0.13	0.07	-0.07	0.07	0.03	0.03	0.07	0.00	-0.03	0.03	0.00
562.34	0.10	0.10	0.13	0.07	0.03	0.07	0.00	-0.03	0.13	0.10	-0.03	0.00	0.07
595.66	0.07	0.10	0.13	0.07	-0.03	0.03	0.00	0.00	0.10	0.07	-0.03	0.07	0.00
630.96	0.03	0.00	0.07	-0.03	0.00	0.07	0.10	0.07	0.13	0.10	0.03	0.10	0.10
668.34	0.10	0.10	0.13	0.07	0.03	0.00	0.03	0.03	0.07	0.00	0.03	0.10	0.00
707.95	0.10	0.10	0.13	0.07	0.03	0.07	0.10	0.07	0.03	0.10	0.03	0.10	0.00
749.89	0.10	0.10	0.13	0.07	0.00	-0.03	0.10	0.07	0.13	0.10	0.03	0.10	0.10
794.33	0.10	0.10	0.13	0.07	0.03	0.13	0.10	0.07	0.13	0.10	0.03	0.10	0.10
841.40	0.03	0.07	0.10	0.07	0.03	0.07	0.10	0.10	0.03	0.10	0.03	0.10	0.10
891.25	0.10	0.07	0.10	0.00	0.03	0.07	0.03	0.07	0.13	0.07	0.03	0.10	0.10
944.06	0.13	0.17	0.20	0.07	0.07	0.07	0.13	0.17	0.20	0.17	0.03	0.17	0.13
1000.00	0.20	0.10	0.13	0.07	0.03	0.17	0.10	0.17	0.23	0.10	0.03	0.10	0.10
1059.25	0.10	0.10	0.23	0.17	0.13	0.07	0.10	0.07	0.13	0.10	0.03	0.10	0.10
1122.02	0.20	0.23	0.23	0.13	0.13	0.17	0.10	0.17	0.23	0.20	0.13	0.13	0.10
1188.50	0.20	0.10	0.23	0.07	0.13	0.17	0.10	0.17	0.13	0.20	0.13	0.17	0.10
1258.93	0.13	0.17	0.23	0.17	0.13	0.17	0.23	0.13	0.23	0.17	0.13	0.10	0.20
1333.52	0.20	0.20	0.33	0.27	0.13	0.17	0.20	0.23	0.23	0.20	0.13	0.20	0.10
1412.54	0.20	0.20	0.23	0.17	0.23	0.17	0.20	0.27	0.23	0.20	0.13	0.17	0.20
1496.24	0.23	0.20	0.23	0.17	0.23	0.17	0.20	0.27	0.23	0.27	0.13	0.10	0.20
1584.89	0.33	0.30	0.37	0.30	0.27	0.27	0.33	0.27	0.30	0.27	0.20	0.27	0.30
1678.80	0.30	0.30	0.40	0.37	0.33	0.27	0.30	0.27	0.33	0.20	0.17	0.20	0.27
1778.28	0.40	0.40	0.43	0.37	0.33	0.33	0.40	0.37	0.33	0.40	0.13	0.30	0.30
1883.65	0.40	0.40	0.43	0.37	0.33	0.37	0.40	0.37	0.33	0.30	0.23	0.30	0.30
1995.26	0.40	0.50	0.43	0.47	0.43	0.47	0.40	0.37	0.37	0.40	0.23	0.33	0.30
2113.49	0.50	0.50	0.53	0.47	0.43	0.47	0.40	0.47	0.43	0.37	0.33	0.33	0.40
2238.72	0.50	0.50	0.53	0.47	0.43	0.47	0.50	0.47	0.47	0.40	0.30	0.40	0.40
2371.37	0.50	0.50	0.53	0.47	0.43	0.47	0.50	0.47	0.53	0.50	0.33	0.50	0.40
2511.89	0.50	0.57	0.53	0.57	0.50	0.57	0.53	0.53	0.53	0.50	0.37	0.47	0.47
2660.73	0.53	0.53	0.57	0.57	0.50	0.50	0.60	0.50	0.53	0.50	0.43	0.50	0.43

Continued on next page

Frequency (Hz)	Angle from Reference direction (degrees)												
	0	15	30	45	60	75	90	105	120	135	150	165	180
2818.38	0.57	0.53	0.57	0.60	0.50	0.50	0.53	0.53	0.57	0.57	0.43	0.57	0.50
2985.38	0.40	0.50	0.43	0.57	0.43	0.50	0.57	0.53	0.57	0.57	0.37	0.50	0.50
3162.28	0.40	0.40	0.53	0.50	0.33	0.57	0.50	0.47	0.53	0.50	0.43	0.50	0.50
3349.65	0.30	0.40	0.37	0.37	0.37	0.43	0.40	0.40	0.43	0.43	0.40	0.50	0.50
3548.13	0.23	0.27	0.33	0.30	0.23	0.37	0.33	0.33	0.37	0.40	0.33	0.40	0.40
3758.37	0.20	0.23	0.13	0.17	0.23	0.27	0.20	0.23	0.33	0.37	0.27	0.40	0.30
3981.07	0.10	0.10	0.13	0.13	0.00	0.13	0.10	0.10	0.23	0.20	0.13	0.27	0.23
4216.97	0.03	0.00	0.10	0.03	-0.10	0.07	0.00	-0.03	0.07	0.03	0.03	0.10	0.13
4466.84	0.00	-0.07	-0.07	-0.07	-0.17	-0.07	-0.10	-0.10	-0.07	0.00	-0.07	0.00	0.00
4731.51	-0.30	-0.20	-0.17	-0.23	-0.27	-0.30	-0.30	-0.43	-0.27	-0.20	-0.37	-0.20	-0.20
5011.87	-0.17	-0.20	-0.17	-0.30	-0.27	-0.23	-0.40	-0.33	-0.37	-0.40	-0.37	-0.30	-0.30
5308.84	0.00	-0.10	-0.07	-0.23	-0.30	-0.33	-0.40	-0.43	-0.47	-0.50	-0.60	-0.43	-0.43
5623.41	0.00	-0.07	-0.03	-0.17	-0.20	-0.33	-0.37	-0.43	-0.47	-0.50	-0.53	-0.43	-0.43
5956.62	0.17	0.07	0.10	-0.13	-0.17	-0.23	-0.33	-0.37	-0.43	-0.50	-0.57	-0.50	-0.40
6309.57	0.10	0.20	0.23	-0.03	-0.07	-0.03	-0.10	-0.33	-0.37	-0.40	-0.47	-0.40	-0.30
6683.44	0.13	0.10	0.20	0.07	-0.03	-0.03	-0.13	-0.17	-0.27	-0.33	-0.40	-0.40	-0.20
7079.46	0.03	0.07	0.07	0.07	0.03	0.00	-0.10	-0.13	-0.17	-0.27	-0.27	-0.23	-0.13
7498.94	-0.10	-0.10	-0.07	-0.03	-0.07	-0.03	-0.20	-0.23	-0.27	-0.20	-0.27	-0.10	-0.10
7943.28	-0.30	-0.37	-0.30	-0.23	-0.33	-0.23	-0.33	-0.40	-0.37	-0.33	-0.33	-0.20	-0.17
8413.95	-0.40	-0.37	-0.37	-0.43	-0.53	-0.43	-0.57	-0.57	-0.57	-0.50	-0.43	-0.23	-0.37
8912.51	-0.40	-0.50	-0.37	-0.53	-0.67	-0.63	-0.70	-0.73	-0.73	-0.80	-0.73	-0.50	-0.50
9440.61	-0.37	-0.40	-0.37	-0.50	-0.67	-0.70	-0.70	-0.83	-0.77	-0.90	-0.93	-0.77	-0.60
10000.00	-0.13	-0.20	-0.27	-0.43	-0.57	-0.57	-0.77	-0.83	-0.77	-0.90	-0.97	-0.90	-0.70
10592.54	-0.20	-0.20	-0.17	-0.40	-0.47	-0.47	-0.70	-0.83	-0.83	-0.83	-0.97	-0.87	-0.70
11220.18	-0.47	-0.43	-0.37	-0.43	-0.53	-0.47	-0.70	-0.90	-0.77	-0.80	-0.77	-0.90	-0.67
11885.02	-0.67	-0.73	-0.63	-0.60	-0.73	-0.57	-0.83	-0.90	-0.83	-0.87	-0.73	-0.70	-0.70
12589.25	-0.57	-0.73	-0.83	-0.87	-0.97	-0.97	-1.00	-1.00	-1.00	-1.17	-1.07	-0.90	-0.90
13335.21	-0.70	-0.67	-0.63	-0.83	-1.00	-1.17	-1.10	-1.07	-1.07	-1.37	-1.53	-1.20	-1.13
14125.38	-0.40	-0.50	-0.57	-0.60	-0.90	-1.00	-1.00	-1.20	-1.17	-1.37	-1.63	-1.47	-1.20
14962.36	-0.70	-0.73	-0.53	-0.73	-0.97	-0.90	-1.10	-1.33	-1.23	-1.50	-1.53	-1.43	-1.13
15848.93	-0.90	-0.90	-0.97	-1.03	-1.27	-1.13	-1.30	-1.60	-1.37	-1.57	-1.37	-1.40	-1.17
16788.04	-0.90	-1.07	-1.00	-1.30	-1.33	-1.47	-1.50	-1.53	-1.40	-1.70	-1.77	-1.43	-1.43
17782.79	-0.87	-0.93	-0.93	-1.10	-1.33	-1.53	-1.70	-1.57	-1.67	-1.73	-2.30	-2.00	-1.70
18836.49	-0.90	-1.10	-0.90	-1.10	-1.43	-1.43	-1.70	-1.83	-1.80	-1.83	-2.13	-2.27	-1.77
19952.62	-1.27	-1.30	-1.13	-1.47	-1.73	-1.67	-2.07	-2.30	-1.97	-2.23	-2.13	-1.97	-1.67

Frequency Response Charts

For frequency response information with PRM2103 preamplifiers and EPS2116 environmental shells, see the respective manuals for these products.

FIGURE A-12 Plane Parallel to Display Screen

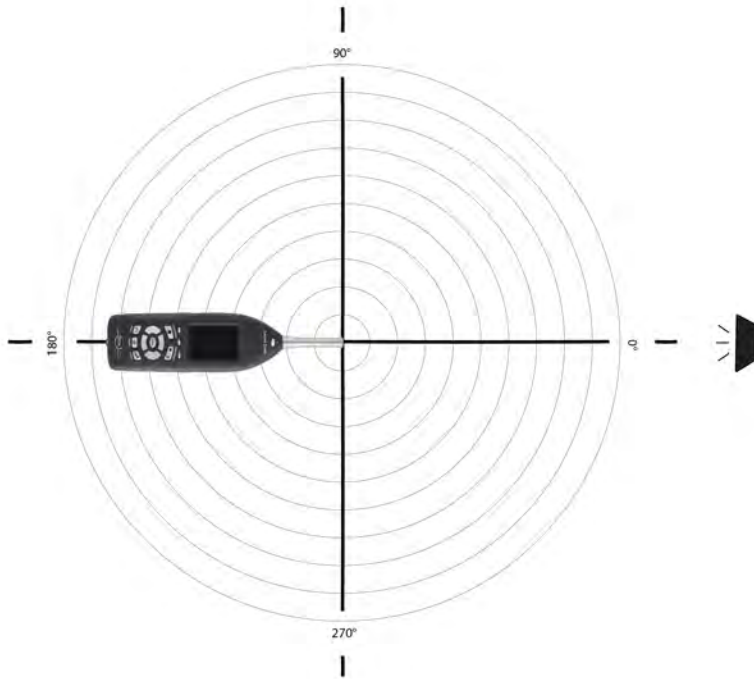

FIGURE A-13 Model 831 With 377B02 Microphone

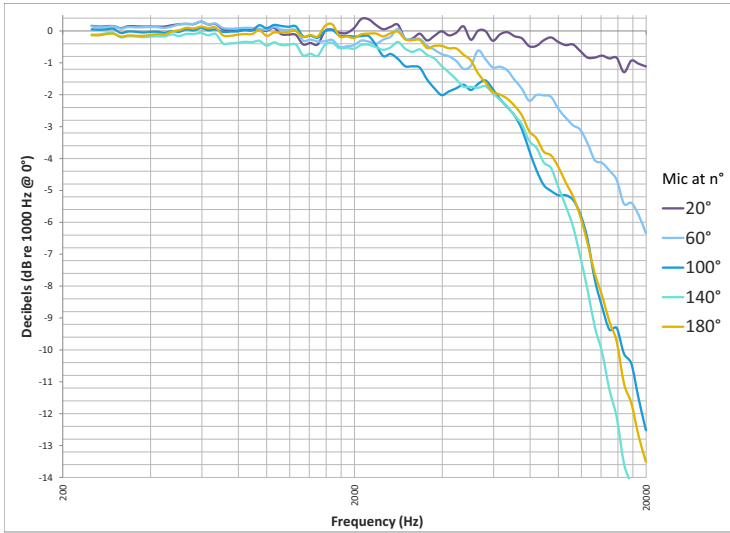

FIGURE A-14 Model 831 With 377B02 Microphone

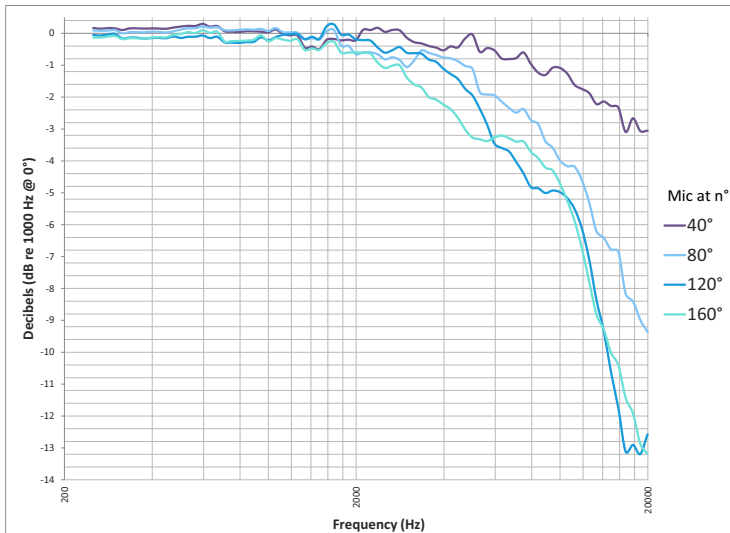

FIGURE A-15 Model 831 With 377B02 Microphone

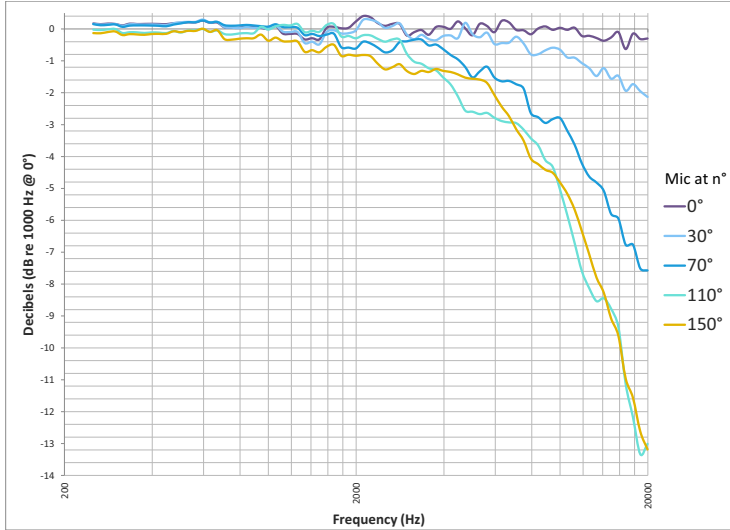
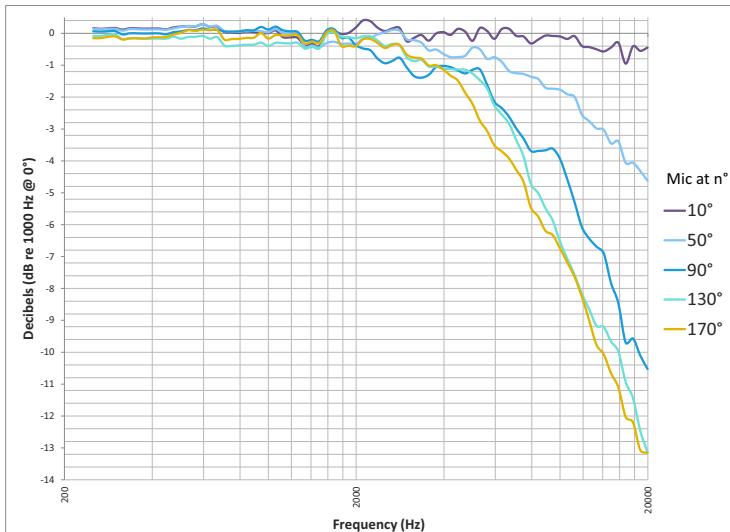

FIGURE A-16 Model 831 wWith 377B02 Microphone



Directional Characteristics

FIGURE A-17 Model 831 With 377B02: 1000 Hz

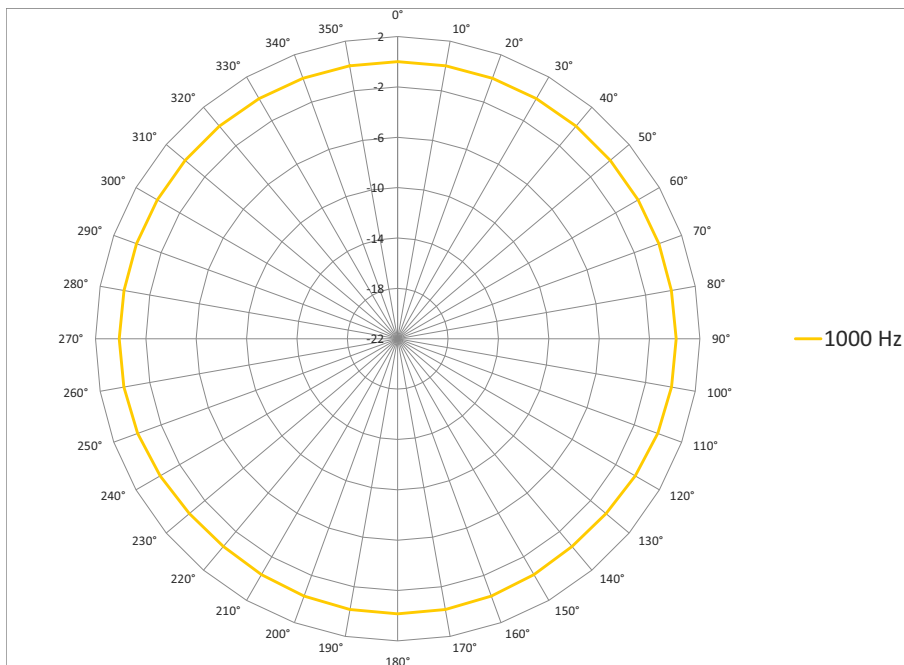

FIGURE A-18 Model 831 With 337B02

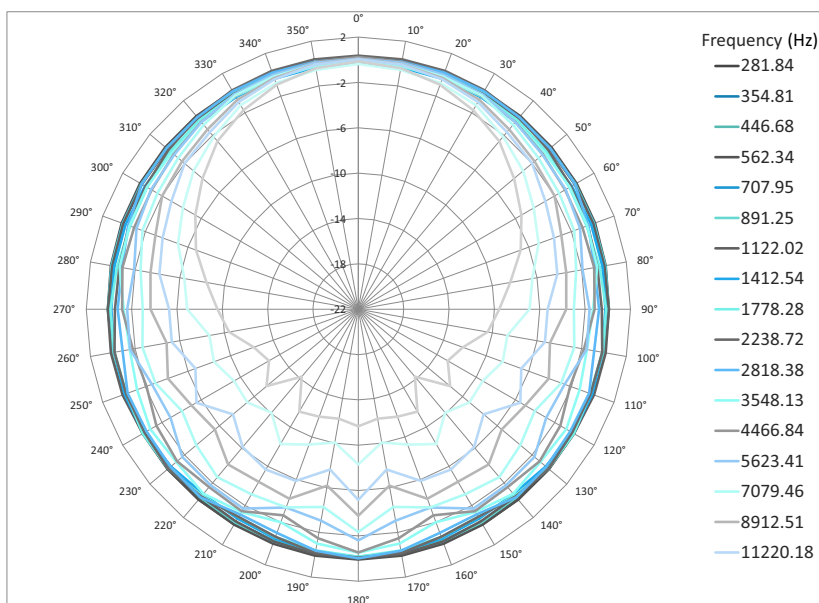

FIGURE A-19 Model 831 With 377B02 Microphone

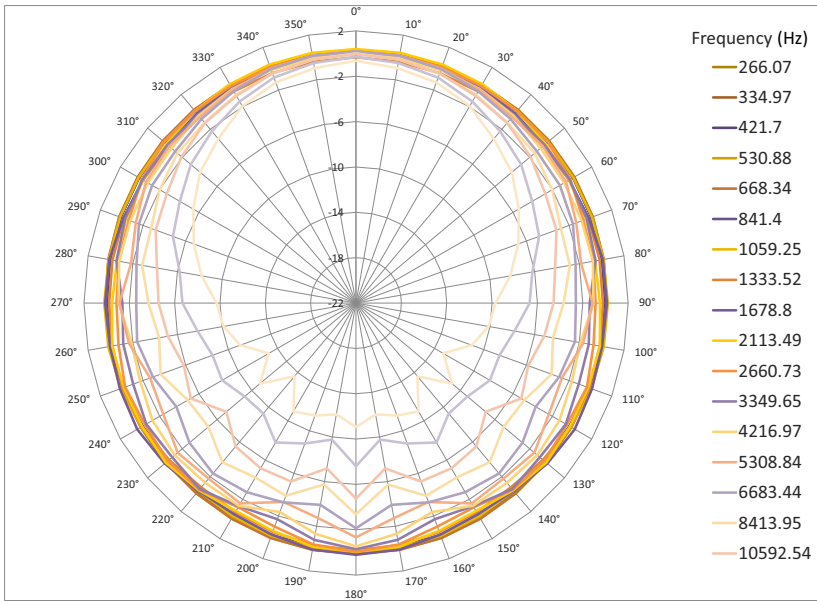

FIGURE A-20 Model 831 With 377B02 Microphone

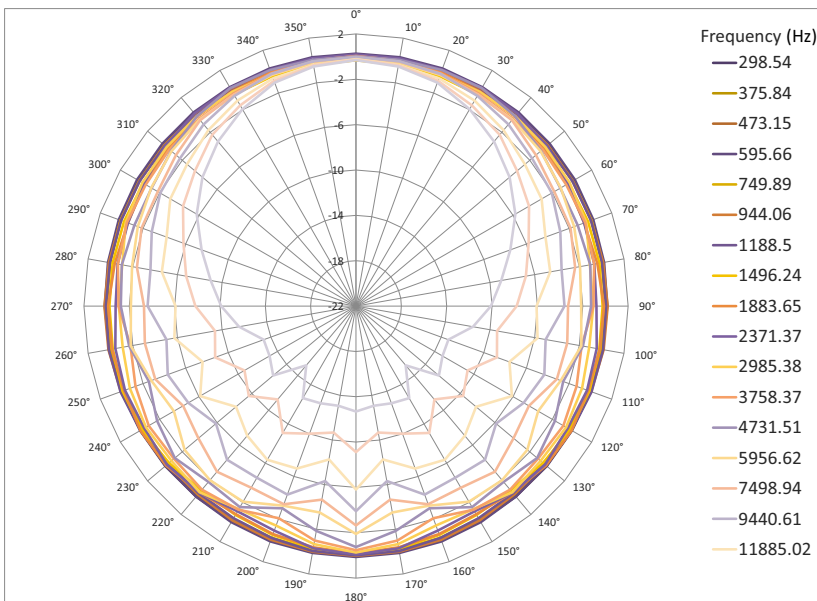

FIGURE A-21 Model 831 With 377B02 Microphone

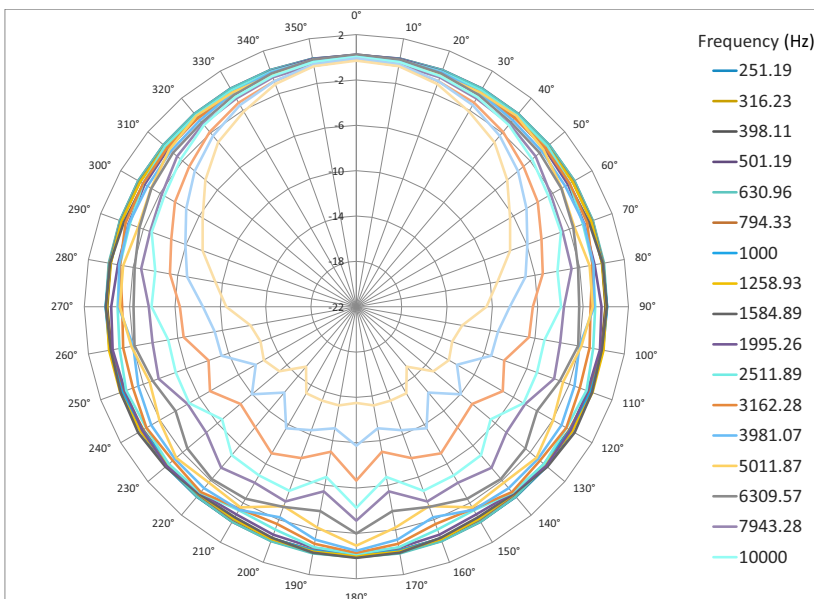

FIGURE A-22 Model 831 With 377B02 Microphone

Plane Perpendicular to Display Screen

FIGURE A-23 Reference Angle

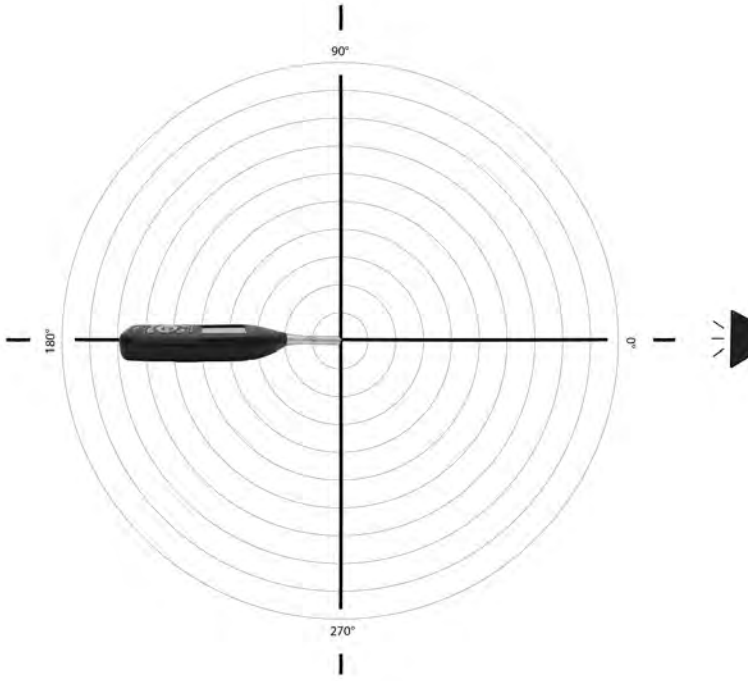

FIGURE A-24 Model 831 with 377B02 Microphone

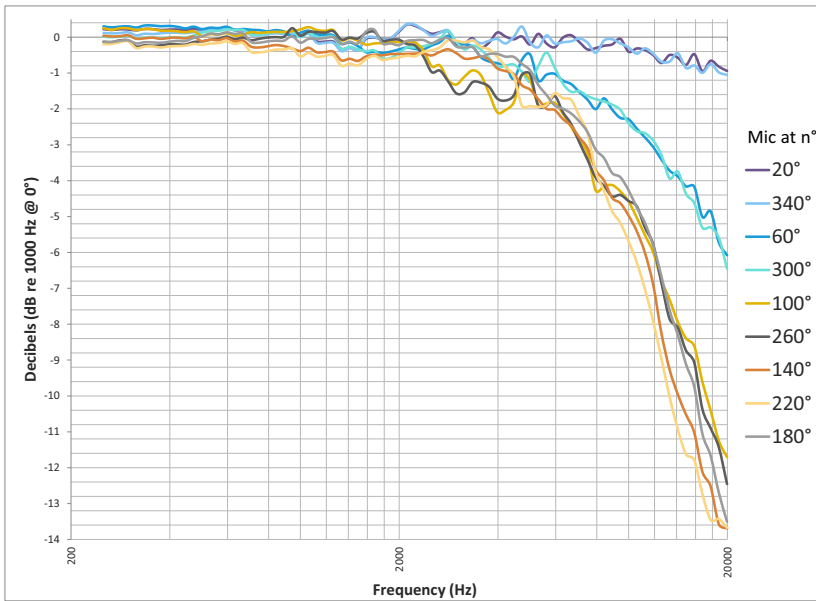

FIGURE A-25 Model 831 with 377B02 Microphone

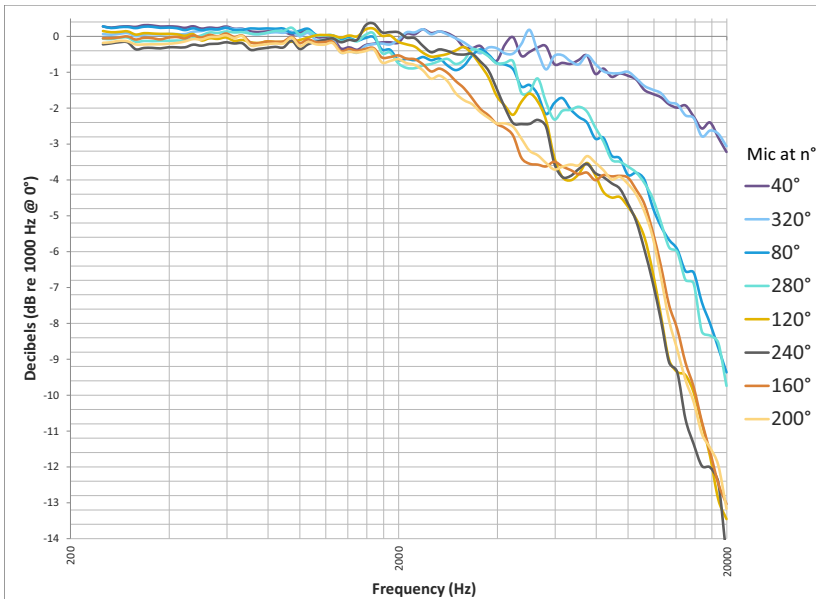

FIGURE A-26 Model 831 with 377B02 Microphone

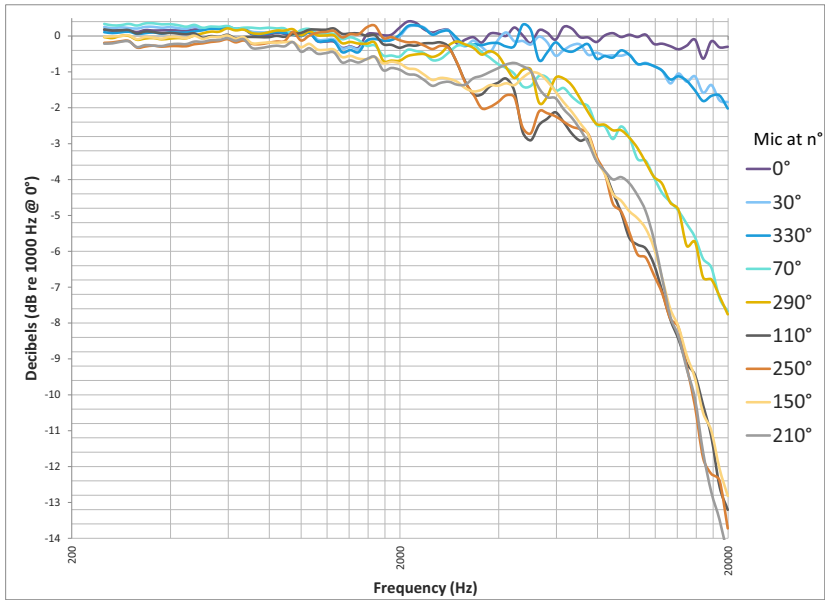
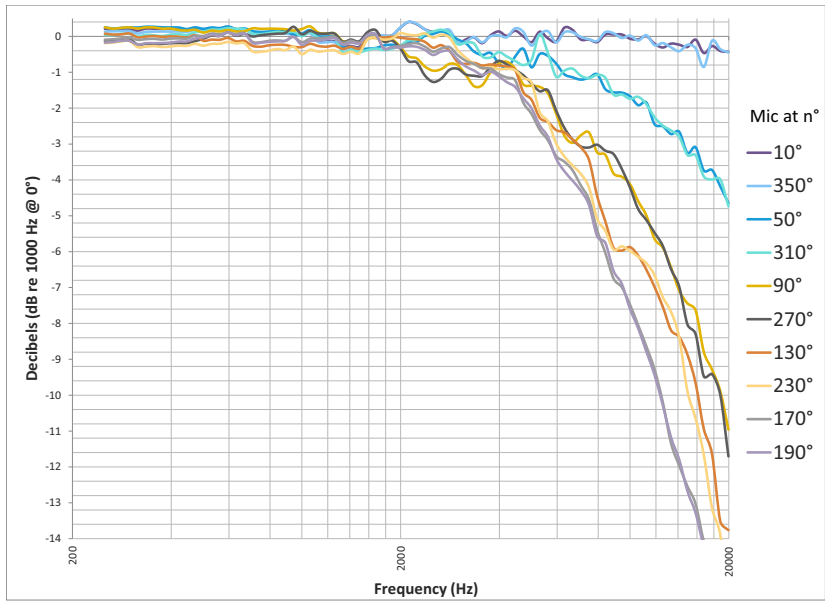

FIGURE A-27 Model 831 with 377B02 Microphone



Directional Characteristics

FIGURE A-28 Model 831 with 377B02 Microphone

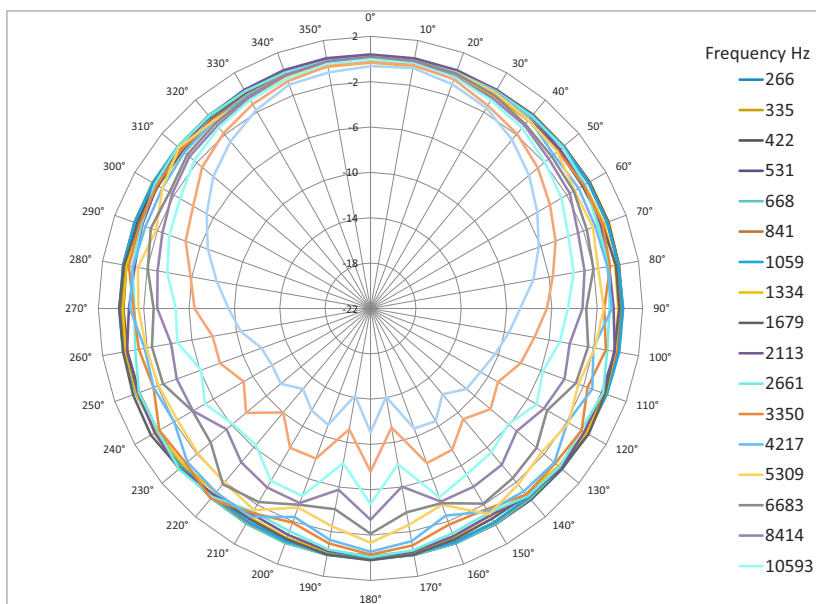

FIGURE A-29 Model 831 with 377B02 Microphone

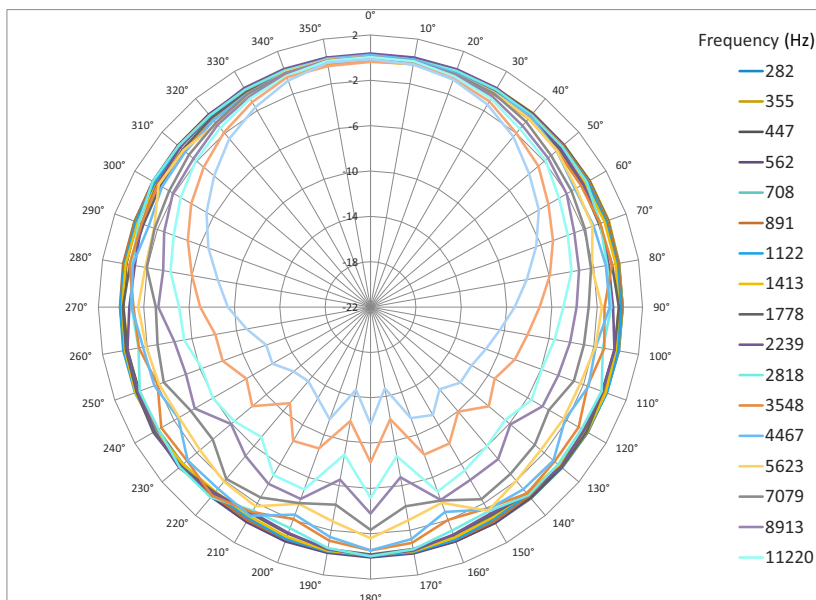

FIGURE A-30 Model 831 with 377B02 Microphone

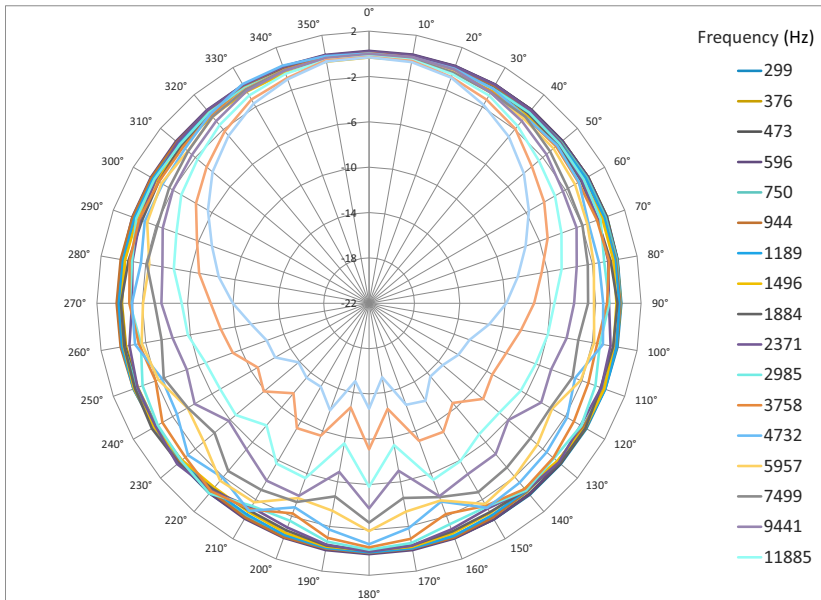
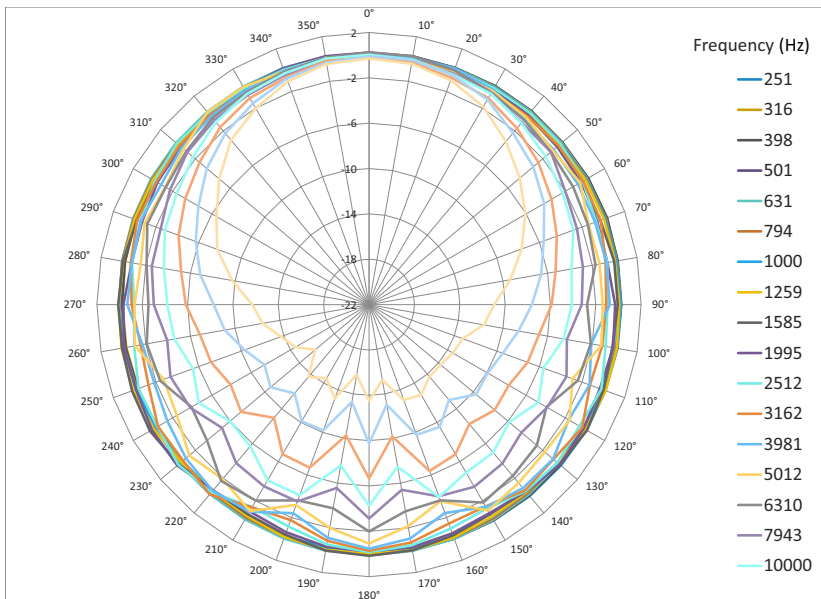
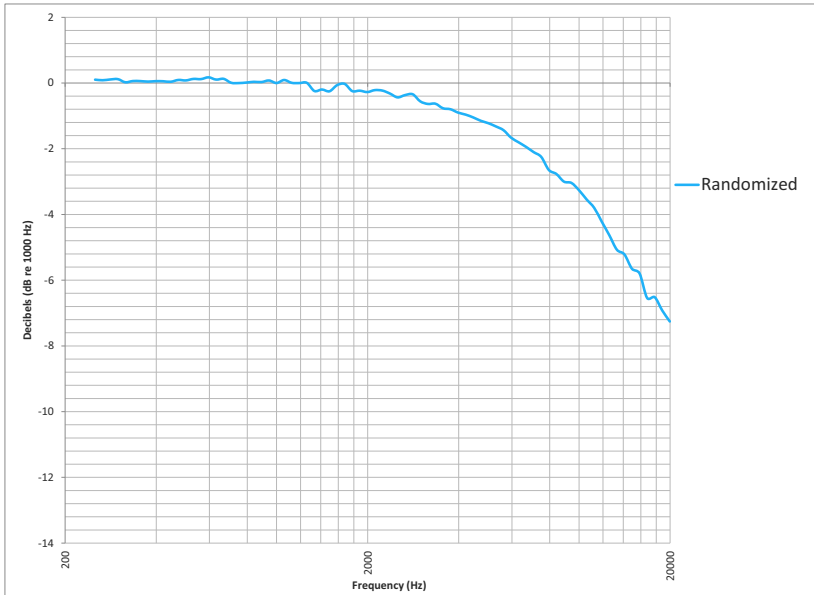

FIGURE A-31 Model 831 with 377B02 Microphone



Random Incidence

FIGURE A-32 Model 831 with 377B02 Microphone: Random Incidence



Noise Levels

The noise of the Model 831 includes contributions from the following components:

- Instrument and preamplifier
- Microphone

Noise Level as a Function of 1/3 Octave Frequency Bands

In the following sections, the noise levels for each component, and the total, are presented as a function of 1/3 octave frequency bands.

FIGURE A-33 As Labeled

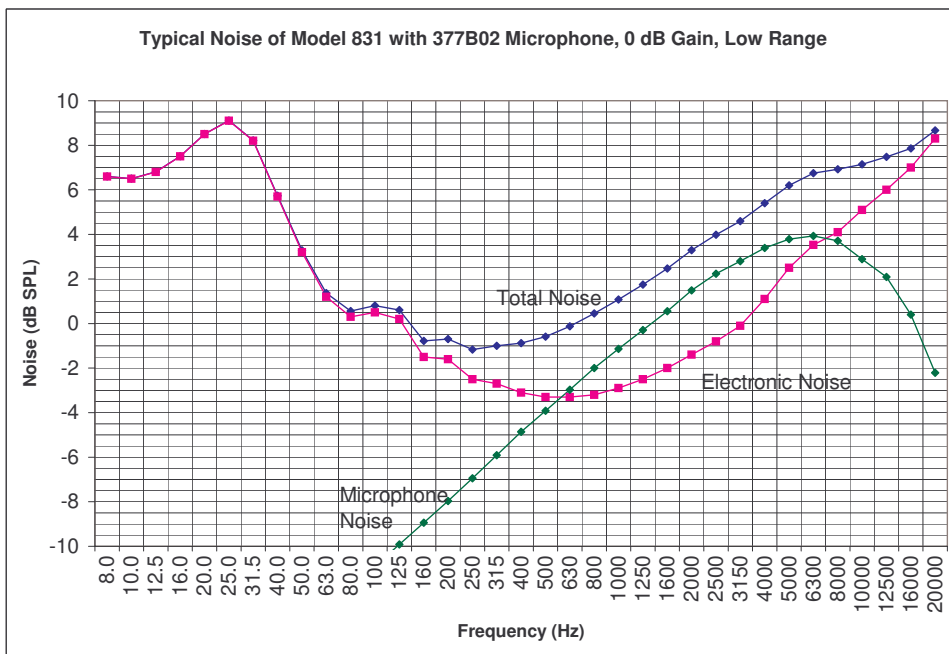

FIGURE A-34 As Labeled

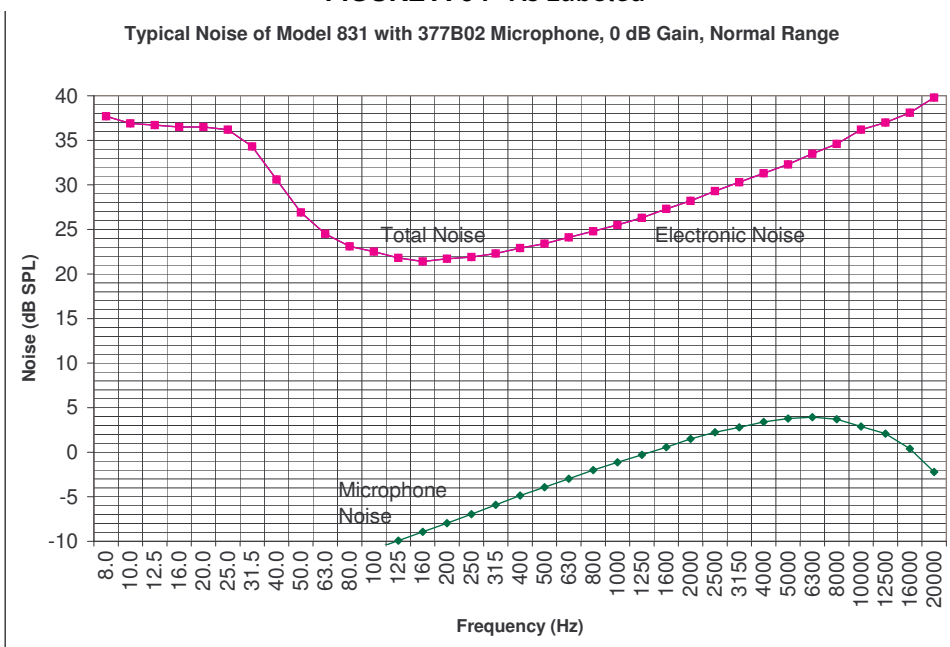

FIGURE A-35 As Labeled

Typical Noise of Model 831 with 377B02 Microphone, 20 dB Gain, Low Range

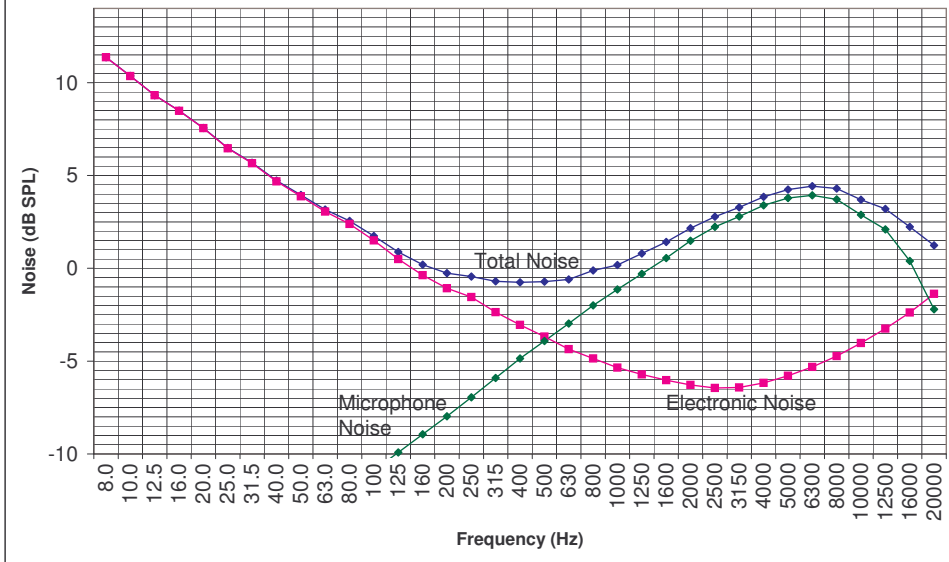
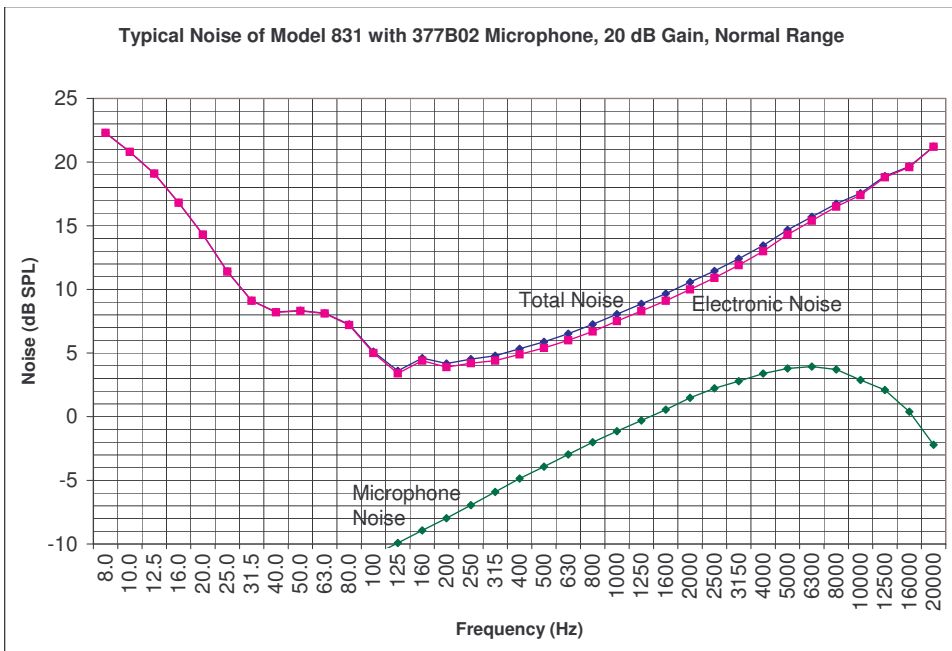

FIGURE A-36 As Labeled

Typical Noise of Model 831 with 377B02 Microphone, 20 dB Gain, Normal Range



Noise Level as a Function of Octave Frequency Bands

In the following sections, the noise levels for each component—and the total noise level—are presented as a function of octave frequency bands.

FIGURE A-37 Noise of Model 831 with 377B02: 0 dB Gain, Low Range

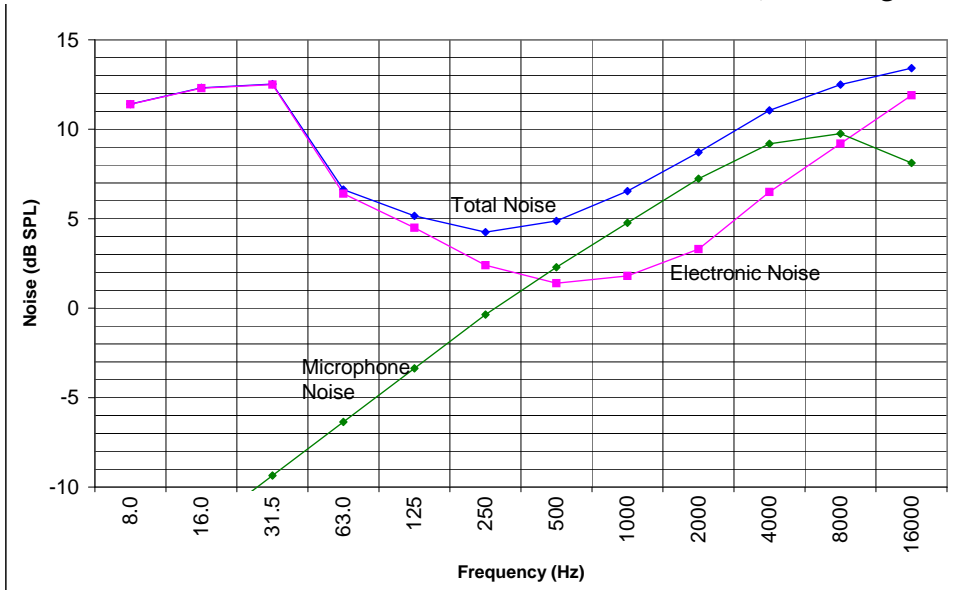

FIGURE A-38 Noise of Model 831 with 377B02: 0 dB Gain, Normal Range

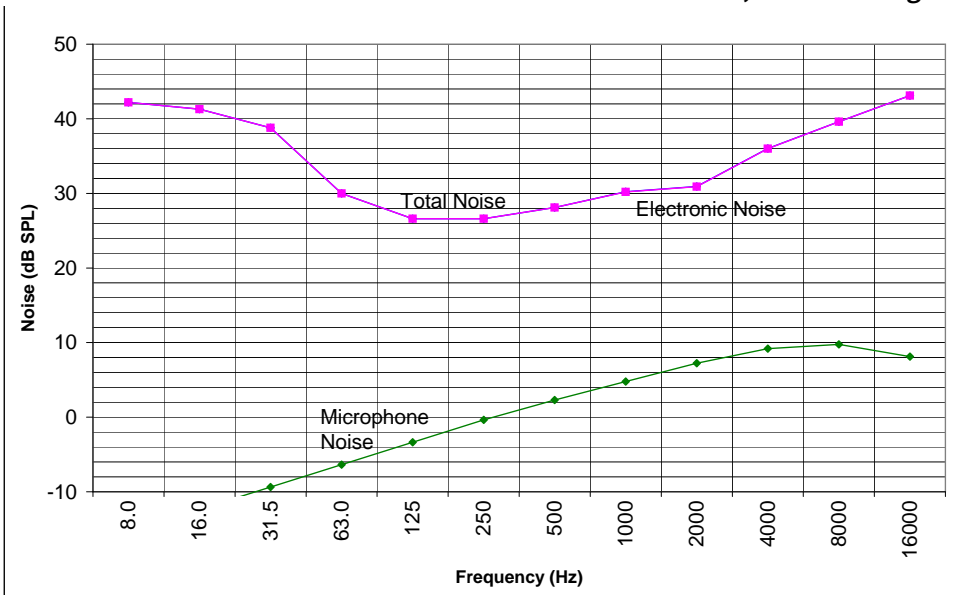

FIGURE A-39 Noise of Model 831 with 377B02: 20 dB Gain, Low Range

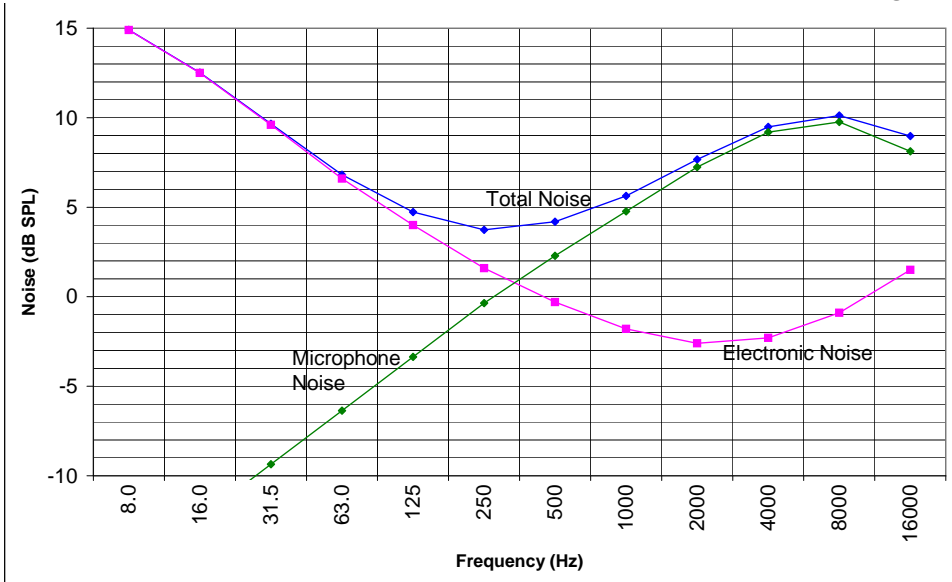
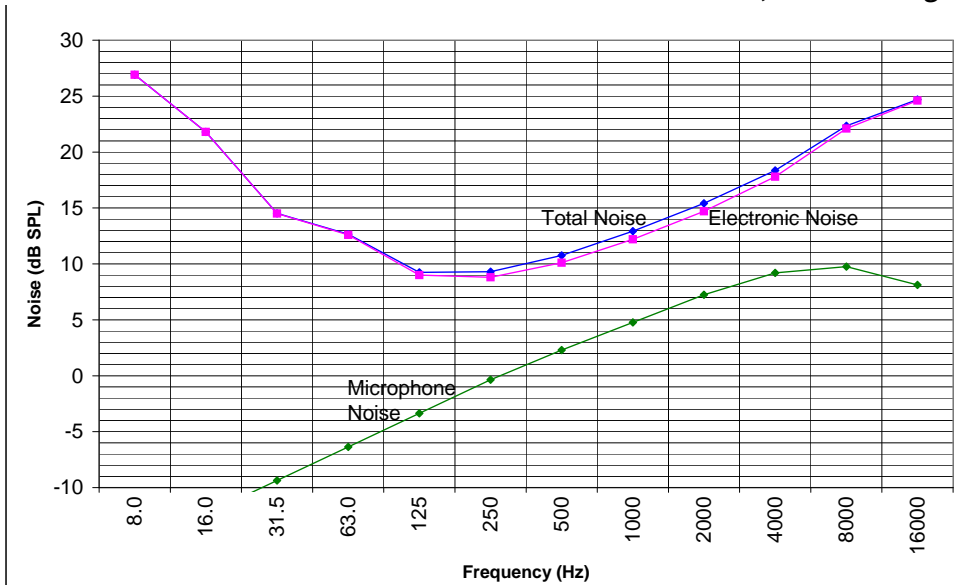

FIGURE A-40 Noise of Model 831 with 377B02: 20 dB Gain, Normal Range



Broadband Noise Levels

The A, C, and Z-weighted self-generated noise levels for Model 831—including the 377B02—are presented in Table .

Table 24: Model 831 Self-Generated Noise

Self-Generated Electrical Noise ¹				
Weighting	0 dB Gain		+20 dB Gain	
	Typical (dB)	Max (dB)	Typical (dB)	Max (dB)
A	13	15	6	10
C	15	22	12	16
Z	22	25	19	26
Self-Generated Total Noise ²				
Weighting	0 dB Gain		+20 dB Gain	
	Typical (dB)	Max (dB)	Typical (dB)	Max (dB)
A	18	19	17	17
C	18	23	17	19
Z	23	26	21	26

1. Electronic noise of the instrument with an ADP090 (12 pF) in place of the microphone.

2. Combination of the electronic noise and the thermal noise of the 377B02 microphone at 20° measured in a sealed cavity and vibration isolated with an averaging time of 60 seconds.

Microphone Preamplifier Specifications

For PRM2103 preamplifier specifications, see the PRM2103 Manual.

FIGURE A-41 Model 831 with Various Microphones and Preamplifiers

Preamplifier Type	Microphone Type	Nominal Microphone Sensitivity	Nominal Preamplifier Gain	Nominal Sensitivity at 831 Input		Sensitivity Limits	
		mV/Pa	dB	mV/Pa	dB re. 1V/Pa	High	Low
						dB re. 1V/Pa	dB re. 1V/Pa
PRM831	377B02	50	-0.1	49.4	-26.1	-23.1	-29.1
PRM831	377B20	50	-0.1	49.4	-26.1	-23.1	-29.1
PRM831 ¹	377B01	2	-2.1	1.57	-56.1	-52.1	-60.1
PRM831 ¹	377B10	1	-2.1	0.79	-62.1	-58.1	-66.1
426A12							
0 dB Gain	377B02	50	-0.1	49.4	-26.1	-23.1	-29.1
426A12							
20 dB Gain	377B02	50	19.9	494.3	-6.1	-3.1	-9.1
426A12							
0 dB Gain	377B20	50	-0.1	49.4	-26.1	-23.1	-29.1
426A12							
20 dB Gain	377B20	50	19.9	494.3	-6.1	-3.1	-9.1

1. Using ADP043

Model PRM831

The Larson Davis PRM831 is an electret microphone preamplifier for use with a Larson Davis Model 831 Sound Level Meter. It requires little supply current and is capable of driving 300 feet of cable. The preamplifier operates over wide ranges of temperature and humidity. It has very little attenuation for use with 50 mV/Pa sensitivity microphones up to 140 dBSPL.

Model PRM831 Specifications

Frequency response

With respect to the response at 1 kHz with 1 Volt rms input and 12 pF equivalent microphone, the frequency response is as follows:

8 Hz to 16 Hz +0.1, -0.2 dB

16 Hz to 100 kHz +0.1, -0.1 dB

Lower -3 dB limit < 1.5 Hz

Attenuation

0.1 dB (typical)

Input Impedance

10 G Ohm // 0.16 pF

Output Impedance

50 Ohm

Maximum Output

28 Vpp

143 dB peak for microphones with 50 mV/Pa sensitivity

Maximum Output Current

12 mA peak

Distortion

Harmonics <-70 dBC with 8 Volt rms output at 1 kHz

Output Slew Rate

2 V/μS (typical)

Electronic Noise

with 12 pF equivalent microphone

1.8 μV typical A-weighted (2.4 μV max)

4.3 μV typical Flat 20 Hz to 20 kHz (5.0 μV max)

Power Supply Voltage

15 to 36 Volts

DC Output Level

~1/2 power supply voltage

Power Supply Current

1.9 mA typical

Temperature Sensitivity

<±0.05 dB from -40° to +80° C (14° to +176 °F)

Humidity Sensitivity

<±0.05 dB from 0 to 90% RH, non-condensing at 50° C (122 °F)

Dimensions

12.7 mm diameter x 73 mm length (0.50" diameter x 2.88" length)

Microphone Thread

11.7 mm - 60 UNS (0.4606 - 60 UNS)

Cable Driving Capability (<0.1 dB error)

Model 831 SLM: 10 V rms output signal, full scale

- To 50 kHz with 10' (3 m) cable
- To 25 kHz with 200' (61 m) cable
- To 20 kHz with 328' (100 m) cable
- To 18 kHz with 400' (122 m) cable
- To 15 kHz with 500' (152 m) cable
- To 6.3 kHz with 1000' (305 m) cable

Model 831: 3 V rms signal, 10.5 dB below full scale

- To 80 kHz with 200' (61 m) cable
- To 63 kHz with 328' (100 m) cable
- To 50 kHz with 500' (152 m) cable
- To 10 kHz with 1000' (305 m) cable

Test Conditions

All values are at 23° C, 50% RH, 35 Volt supply, 3 m (10') cable and equivalent microphone of 12 pF unless otherwise stated.

Output Connector

Switchcraft TA5M

5-Pin male

Table 25: Output Connector

Pin	Signal
1	Signal Ground
2	Signal Output
3	Power Supply + 35 Volts
4	Preamp sense
5	No Connection
Shell	Connect to preamp housing

Compatibility

Use with an 1/2-inch electret microphone with about 50 mV/Pa sensitivity. This meets the mechanical requirements of IEC 61094-4. Alternatively, use a 1/4-inch electret microphone with the Larson Davis ADP043 adapter.

In the interest of constant product improvement, specifications are subject to change without notice.

Larson Davis provides a complete line of acoustic measurement tools including dosimeters, sound level meters, real time analyzers, preamps, calibrators and microphones.

Table 26: Certificate of Conformance; PRM831

**Preamplifier Model: PRM831 Serial Number: 10123
Certificate of Electrical Conformance**

Frequency response of this model PRM831 preamplifier was tested at a level of 1 Vrms with 12pF microphone capacitance and driving a short cable. Output level at 1kHz is 0.9878 Vrms (-0.107 dBV), uncertainty 0.033 dB. Results are displayed relative to the level at 1kHz.

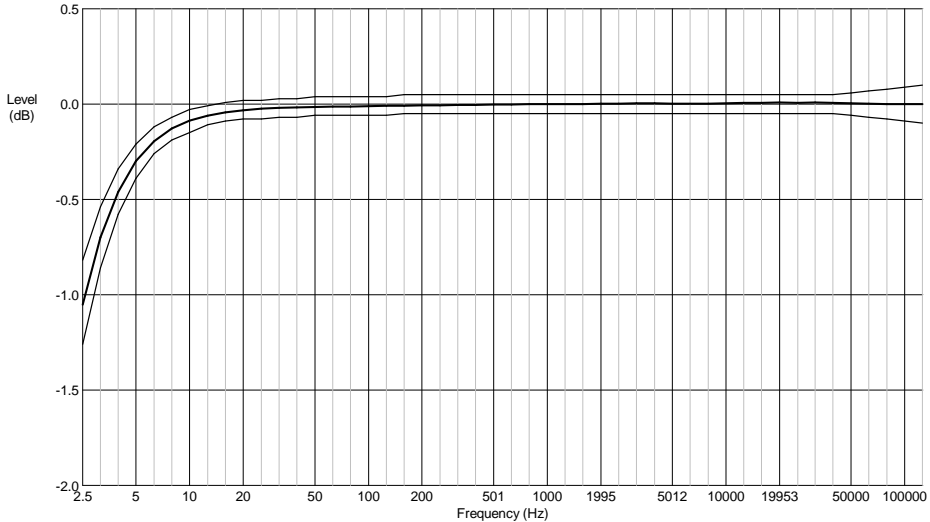

Freq (Hz)	Measured (dB)	Uncert (dB)	Tolerance (dB)	Freq (Hz)	Measured (dB)	Uncert (dB)	Tolerance (dB)
2.51	-1.05	0.075	-0.82, -1.26	630.96	-0.00	0.016	+0.05, -0.05
3.16	-0.70	0.058	-0.54, -0.86	794.33	-0.00	0.016	+0.05, -0.05
3.98	-0.46	0.058	-0.34, -0.58	1000.00	0.00	0.016	+0.05, -0.05
5.01	-0.30	0.036	-0.21, -0.39	1258.90	0.00	0.016	+0.05, -0.05
6.31	-0.20	0.036	-0.12, -0.26	1584.90	0.00	0.016	+0.05, -0.05
7.94	-0.13	0.036	-0.07, -0.19	1995.30	0.00	0.016	+0.05, -0.05
10.00	-0.09	0.016	-0.03, -0.15	2511.90	0.00	0.016	+0.05, -0.05
12.59	-0.06	0.016	-0.01, -0.11	3162.30	0.00	0.016	+0.05, -0.05
15.85	-0.04	0.016	+0.01, -0.09	3981.10	0.01	0.016	+0.05, -0.05
19.95	-0.03	0.016	+0.02, -0.08	5011.90	0.00	0.016	+0.05, -0.05
25.12	-0.03	0.016	+0.02, -0.08	6309.60	0.00	0.016	+0.05, -0.05
31.62	-0.02	0.016	+0.03, -0.07	7943.30	0.00	0.016	+0.05, -0.05
39.81	-0.02	0.016	+0.03, -0.07	10000.00	0.01	0.016	+0.05, -0.05
50.12	-0.02	0.016	+0.04, -0.06	12589.00	0.01	0.016	+0.05, -0.05
63.10	-0.01	0.016	+0.04, -0.06	15849.00	0.01	0.016	+0.05, -0.05
79.43	-0.01	0.016	+0.04, -0.06	19953.00	0.01	0.016	+0.05, -0.05
100.00	-0.01	0.016	+0.04, -0.06	25250.00	0.01	0.022	+0.05, -0.05
125.89	-0.01	0.016	+0.04, -0.06	31500.00	0.01	0.022	+0.05, -0.05
158.49	-0.01	0.016	+0.05, -0.05	39750.00	0.01	0.022	+0.05, -0.05
199.53	-0.01	0.016	+0.05, -0.05	50000.00	0.01	0.022	+0.06, -0.06
251.19	-0.01	0.016	+0.05, -0.05	63000.00	0.00	0.047	+0.07, -0.07
316.23	-0.01	0.016	+0.05, -0.05	79500.00	0.00	0.047	+0.08, -0.08
398.11	-0.00	0.016	+0.05, -0.05	100000.00	0.00	0.047	+0.09, -0.09
501.19	-0.00	0.016	+0.05, -0.05	126000.00	0.00	0.063	+0.10, -0.10

Noise floor data: 1kHz (1/3 Octave) = 0.42 uV, -7.6 dBuV, uncertainty = 0.47 dB
 Flat (20Hz-20kHz) = 4.3 uV, 12.6 dBuV, uncertainty = 0.47 dB
 Awt = 1.8 uV, 4.9 dBuV, uncertainty = 0.46 dB

Uncertainties are given as expanded uncertainty at ~95% confidence interval (k = 2).

Technician: Leroy Harbaugh Test Date: 10OCT2007

Vibration Sensitivity

In the following tables the "Ref" column represents the noise level measured by an equivalent stationary microphone.

Vibration Parallel to Microphone Diaphragm

Table 1: Axis of Vibration Parallel to the Microphone Diaphragm

Frequency	L_{aeq}	Ref
31.5	35.7	35.4
63	35.5	34.8
125	35.8	36.8
250	47.7	47.9
500	52.6	51.4
630	60.5	50.4
800	61.0	54.4
1,000	62.2	60.0

Vibration Perpendicular to Microphone Diaphragm

Table 2: Axis of Vibration Perpendicular to the Microphone Diaphragm

Frequency	L_{aeq}	Ref
31.5	35.9	35.6
63	38.6	34.5
125	46.0	35.5
250	54.1	39.4
500	67.1	44.2
630	82.6	70.0
800	69.7	45.7
1,000	69.2	51.7

B

Measuring to IEC61672-1

This appendix presents information for measuring the sound level meter functionality of the Model 831 according to IEC61672-1.

Sections 5, 6, 7 and 9 (except 9.3)

The following table references sections and tables in this manual where information called for in specific sections of IEC61672-1 can be found. In certain instances the requested information is not applicable, as noted in the Comments column.

Further information called for in section 9.3 for testing, as appropriate for a sound level meter, can be found in "Section 9.3" on page B-7.

Section	Model 831 Manual	Comments
5.1.4	"Hardware Features" on page 1-1	
5.1.6	"Microphone" on page 1-4 and Chapter 7 "Making a Measurement" on page 7-1.	
5.1.7	"Connecting the Microphone and Preamplifier" on page 2-2 and "Connecting the Preamplifier" on page 2-3	
5.1.8		Computer software is not an integral part of the Model 831
5.1.10	"Frequency Weightings" on page A-10.	
5.1.12		The Model 831 measures sound level using a single range
5.1.13	"Section 9.3" on page B-7	
5.1.14	"Overview" on page 3-1 and "Overall SLM" on page 5-15	
5.1.15	"AC/DC Output" on page A-14 and "h) Electrical Insert Signals" on page B-10	
5.1.16	"Microphones and Microphone Preamplifiers" on page 3-3	

Section	Model 831 Manual	Comments
5.1.17	"j) Highest Sound Pressure Level" on page B-10	
5.1.18		The Model 831 is a single channel instrument
5.1.19	"Start-up Period" on page 7-2	
5.2.1	"Calibrator" on page 8-5	
5.2.3	"Acoustic Calibration" on page 8-5	
5.2.4	Item d. in "9.2.4 Adjustments at the Calibration Check Frequency" on page B-5	
5.2.5	"e) Frequency Responses and Corrections" on page B-8	
5.5.10	"g) Linear Measurement Starting Level" on page B-9	
5.5.11	"g) Linear Measurement Starting Level" on page B-9	
5.7.1	"Noise Levels" on page A-42	
5.7.2	"Noise Levels" on page A-42	
5.7.3	"Noise Levels" on page A-42	
5.7.4	"Noise Levels" on page A-42	
5.7.5	"Low Level Sound Fields" on page 7-16	
5.8.1	"Sound Level Meter Specifications" on page A-3	
5.11	"Overload Indication" on page 7-8	
5.12.1	"Under Range Icon" on page 3-9	
5.12.2		Model 831 measures sound level using a single range. The lower limit for level linearity error is caused by the inherent noise from the microphone and electronic elements within the sound level meter.
5.13.1	"Performance Specifications" on page A-3	

Section	Model 831 Manual	Comments
5.17	"Threshold and Criterion" on page 9-4	
5.18.1	Chapter 5 "Data Display" on page 5-1	
5.18.2	Chapter 5 "Data Display" on page 5-1	
5.18.3	Chapter 5 "Data Display" on page 5-1	
5.18.4	"General Specifications" on page A-7	
5.18.5	"Software CD" on page 1-4	
5.18.6		Model 831 uses no alternative display devices
5.19.1	"AC/DC Output" on page A-14 and "Jack Function" on page 18-13	
5.20.1	"Control Tab" on page 4-9 and "Time" on page 18-3	
5.20.1	"Time of Day Drift" on page A-16	
5.20.2	"Min/Max Integration Time" on page A-15	
5.21.1	"Microphone Extension Cable" on page 7-4	
5.21.2	"n) Radio Frequency Emission" on page B-11	
5.22.2		The Model 831 is a single channel instrument
5.23.2	"k) Battery Power Voltage Range" on page B-10	
5.23.3	"Power Supply" on page A-16	
5.23.5	"Power Supply" on page A-16	
5.20.5	"Power Supply" on page A-16	
6.1.2	"l) Typical Stabilization Time" on page B-10	
6.2.2	"Calibration Overview" on page 8-1	
6.2.2 Note	"Model 831 with 1/2" Free-Field Microphone" on page 8-6	
6.5.2	"General Specifications" on page A-7	

Section	Model 831 Manual	Comments
6.6.1	"o) AC Power and Radio Frequency Susceptibility" on page B-11	
6.6.3		No detectable increase in any direction with application of 74 dB A-weighted sound level.
6.6.10	"o) AC Power and Radio Frequency Susceptibility" on page B-11	
6.7	"Vibration" in "Glossary"	
7.1	"Microphone Extension Cable" on page 7-4	
7.2	"Effect of Windscreen" on page A-29	
7.4	"Octave Band Analyzer Tab (Optional)" on page 4-6	
9.2.1 General		
a	"Standards Met by Model 831" on page A-1	
b	"Configuration of the System" on page 7-1 "Microphone Extension Cable" on page 7-4 and "Use of a Windscreen" on page 7-4.	
c	"Standard Accessories" on page 1-4	
d		No microphone extension or microphone extension cable is required to meet specified standards
e		The Model 831 is a single channel instrument
9.2.2 Design Features		
a	Chapter "Parameters Measured" on page 24-1	
b	"Frequency Response Charts" on page A-31	
c	"Frequency Weightings" on page A-10	
d	"Sound Level Meter Specifications" on page A-3	
e	"Performance Specifications" on page A-3	

Section	Model 831 Manual	Comments
f	"20 dB Gain" on page 4-5	
g	"General Specifications" on page A-7	
h	"Performance Specifications" on page A-3	
i	"Performance Specifications" on page A-3	
j		Computer software is not an integral part of the Model 831
k		Additional metrics measured, not specified by the IEC 61672 standard, perform to their respective standards published elsewhere, for example Takt Maximal and SEA

9.2.3 Power Supply

a	"Power Supply" on page A-16	
b	"Power Indicator" on page 3-7 and "k) Battery Power Voltage Range" on page B-10	
c	"Power Supply" on page A-16	
d	"Power Supply" on page A-16	

9.2.4 Adjustments at the Calibration Check Frequency

a	"Recommended Calibrator" on page 8-5	
b	"Recommended Calibrator" on page 8-5	
c	"Acoustic Calibration" on page 8-5	
d	See "9.2.4 d Frequency Responses and Corrections" on page B-8	

9.2.5 Operating the Sound Level Meter

a	"General Specifications" on page A-7	
b	"Positioning the Model 831" on page 7-3	
c	"Low Level Sound Fields" on page 7-16	
d	"Start-up Period" on page 7-2	

Section	Model 831 Manual	Comments
e	"Integration Method" on page 4-5	
f	"Control Tab" on page 4-9 and "Time" on page 18-3	
g	"Manual Stop, Timed Stop or Stop When Stable" on page 6-4	
h	"Overview" on page 3-1 and "Overall SLM" on page 5-15	
i	"Overload Indication" on page 7-8 and "Overall SLM" on page 5-15 and "Run Pending Icon" on page 3-11	
j	"Measurement Range" on page 7-8	
k	"Threshold and Criterion" on page 9-4	
l	"Software CD" on page 1-4 and "Overview" on page 3-1	
m	"Overview" on page 3-1	
n	"AC/DC Output" on page A-14 and "Jack Function" on page 18-13	

9.2.6 Accessories

a	"Effect of Windscreen" on page A-29	
b	"Microphone Extension Cable" on page 7-4	
c	"Octave Band Analyzer Tab (Optional)" on page 4-6	
d		No manufacturer-provided auxiliary devices are provided

9.2.7 Influence of variations in environmental conditions

a		No components of the Model 831 are intended to be operated only in an environmentally controlled enclosure
b	"General Specifications" on page A-7	
c	"CE Information" on page A-18	

Section 9.3

a) Reference Sound Pressure Level

The reference sound pressure level is 114 dB re 20 μ Pa.

b) Reference Level Range

The reference level range is normal.

c) Microphone Reference Point

The microphone reference point is the center of the diaphragm of the 377B02 microphone.

d) Periodic Testing

Table 2 lists values of Larson Davis 831 with PRM831 and 377B02 Microphone adjustment data of A-weighted levels used for periodic measurements.

e) Frequency Responses and Corrections

Larson Davis 831 with PRM831 and 377B02 Microphone average frequency responses and corrections Required by IEC 61672-1							
Exact Frequency	0° Free Field Response	0° Free Field Corrections ¹	Effect of Wind Screen	Wind Screen on 831	0° Free Field Corrections with Wind Screen	0° Free Field Corrections with Wind Screen on 831 ¹	expanded uncertainty of Corrections @ 95%
Hz	dB	dB	dB	dB	dB	dB	dB
251.19	0.0	0.0	0.0	0.0	0.0	0.0	0.1
316.23	-0.1	0.1	0.1	0.1	0.0	0.0	0.1
398.11	0.2	-0.2	-0.1	0.1	-0.1	-0.1	0.1
501.19	0.2	-0.2	-0.1	0.1	-0.1	-0.1	0.1
630.96	0.2	-0.2	-0.1	0.1	-0.1	-0.1	0.1
794.33	0.2	-0.2	-0.1	0.1	-0.1	-0.1	0.1
1000.00	0.0	0.0	0.0	0.0	0.0	0.0	0.1
1059.25	0.0	0.0	0.1	0.1	-0.1	-0.1	0.1
1122.02	-0.2	0.1	0.1	-0.1	0.1	0.1	0.1
1188.50	-0.2	0.2	0.1	-0.1	0.1	0.1	0.1
1258.93	-0.4	0.4	0.3	-0.1	0.1	0.1	0.1
1333.52	-0.3	0.3	0.2	-0.1	0.1	0.1	0.1
1412.54	-0.2	0.2	0.1	-0.1	0.1	0.1	0.1
1496.24	-0.1	0.1	0.0	-0.1	0.1	0.1	0.1
1584.89	0.0	0.0	0.2	0.2	-0.2	-0.2	0.1
1678.80	0.0	0.0	0.3	0.3	-0.3	-0.3	0.1
1778.28	0.0	0.0	0.3	0.3	-0.3	-0.3	0.1
1883.65	-0.1	0.1	0.4	0.3	-0.3	-0.3	0.1
1995.26	0.2	-0.2	0.4	0.6	-0.6	-0.6	0.1
2113.49	0.4	-0.4	0.4	0.8	-0.8	-0.8	0.1
2238.72	0.3	-0.3	0.5	0.8	-0.8	-0.8	0.1
2371.37	0.0	0.0	0.6	0.6	-0.6	-0.6	0.1
2511.89	0.0	0.0	0.6	0.6	-0.6	-0.6	0.1
2660.73	0.2	-0.2	0.4	0.6	-0.6	-0.6	0.1
2818.38	0.0	0.0	0.6	0.6	-0.6	-0.6	0.1
2985.38	-0.2	0.2	0.3	0.1	-0.1	-0.1	0.1
3162.28	0.0	0.0	0.3	0.3	-0.3	-0.3	0.1
3349.65	0.0	0.0	0.1	0.1	-0.1	-0.1	0.1
3548.13	-0.1	0.1	0.0	-0.1	0.1	0.1	0.1
3758.37	0.1	-0.1	0.0	0.1	-0.1	-0.1	0.1
3981.07	0.1	-0.1	0.0	0.1	-0.1	-0.1	0.1
4216.97	0.0	0.0	-0.2	-0.2	0.2	0.2	0.1
4466.84	0.4	-0.4	-0.3	0.1	-0.1	-0.1	0.1
4731.51	0.1	-0.1	-0.4	-0.3	0.3	0.3	0.1
5011.87	-0.1	0.1	-0.4	-0.5	0.5	0.5	0.1
5308.84	0.0	0.0	0.0	0.0	0.0	0.0	0.1
5623.41	0.0	0.0	-0.1	-0.1	0.1	0.1	0.1
5956.62	0.1	-0.1	-0.2	-0.1	0.1	0.1	0.1
6309.57	0.2	-0.2	0.2	0.4	-0.4	-0.4	0.1
6683.44	0.1	-0.1	0.2	0.3	-0.3	-0.3	0.1
7079.46	0.1	-0.1	0.1	0.2	-0.2	-0.2	0.1
7498.94	0.0	0.0	-0.1	-0.1	0.1	0.1	0.1
7943.28	0.0	0.0	-0.3	-0.3	0.3	0.3	0.1
8413.95	0.3	-0.3	-0.4	-0.1	0.1	0.1	0.1
8912.51	0.1	-0.1	0.1	0.2	-0.2	-0.2	0.1
9440.61	0.0	0.0	0.0	0.0	0.0	0.0	0.1
10000.00	0.0	0.0	0.2	0.2	-0.2	-0.2	0.1
10592.54	0.1	-0.1	0.1	0.2	-0.2	-0.2	0.1
11220.18	0.1	-0.1	-0.1	0.0	0.0	0.0	0.1
11885.02	0.0	0.0	-0.2	-0.2	0.2	0.2	0.1
12589.25	0.3	-0.3	-0.3	0.0	0.0	0.0	0.1
13335.21	0.3	-0.3	-0.3	0.0	0.0	0.0	0.1
14125.38	0.1	-0.1	-0.2	-0.1	0.1	0.1	0.1
14962.36	0.1	-0.1	-0.1	0.0	0.0	0.0	0.1
15848.93	-0.2	0.2	0.4	0.2	-0.2	-0.2	0.2
16788.04	-0.2	0.2	0.1	-0.1	0.1	0.1	0.2
17782.79	-0.1	0.1	-0.1	-0.2	0.2	0.2	0.1
18836.49	-0.2	0.2	-0.4	-0.6	0.6	0.6	0.1
19952.62	-0.1	0.1	-1.4	-1.5	1.5	1.5	0.1

SLM with PRM831 and 377B02 Microphone

Frequency	0° Free Field Corrections from B&K 4226 Calibrator ¹	0° Free Field Corrections with WS from B&K 4226 Calibrator ¹	0° Free Field Corrections from B&K UA0033 EA ¹	0° Free Field Corrections with WS from B&K UA0033 EA ¹	expanded uncertainty of Corrections @ 95% confidence
Hz	dB re 1000 Hz	dB re 1000 Hz	dB re 1000 Hz	dB re 1000 Hz	dB
31.62	-0.14	-0.14	-0.09	-0.09	0.25
63.10	-0.11	-0.11	-0.09	-0.09	0.25
125.89	-0.21	-0.21	-0.20	-0.20	0.25
251.19	-0.08	-0.08	-0.09	-0.09	0.25
501.19	-0.22	-0.12	-0.22	-0.12	0.25
1000.00	0.00	0.00	0.00	0.00	0.25
1995.26	-0.05	-0.45	-0.02	-0.42	0.25
3981.07	0.76	0.76	0.78	0.78	0.25
7943.28	2.91	3.21	3.30	3.60	0.35
12589.25	5.85	6.15	6.42	6.72	0.50
15848.93	7.74	7.34	8.46	8.06	0.50

1. add numbers in this column to levels read on the SLM to correct to the 0° Free Field level at frequency

EA - Electrostatic Actuator

WS - Windscreen

Note: Data was taken at reference conditions 23° C, 50% RH, 101.3 kPa

f) Linear Operating Range

A-weighted sound levels for the 831 at the upper and lower limits of the linear operating ranges.

Gain	31.5 Hz	1 kHz	4 kHz	8 kHz	12.5 kHz
0 dB	24 dB to 101 dB	24 dB to 140 dB	24 dB to 141 dB	26 dB to 139 dB	26 dB to 136 dB
20 dB	19 dB to 81 dB	19 dB to 120 dB	19 dB to 121 dB	19 dB to 119 dB	19 dB to 116 dB

g) Linear Measurement Starting Level

The starting point for measuring level linear errors on the reference range is 114 dB.

h) Electrical Insert Signals

The electrical design of the input device to insert electrical signals into the preamplifier is a series 12pF \pm 5% capacitor. The Larson Davis ADP090 is used for this purpose. The ADP090 can be used for noise floor measurements by attaching the included short on the front of the ADP090.

i) Self-generated Noise

Self-generated noise of the Model 831 is shown in Table B-10.

Self-Generated Electrical Noise ²				
Weighting	0 dB gain		20 dB gain	
	typical (dB)	max (dB)	Typical (dB)	max (dB)
A	13	15	6	10
C	15	22	12	16
Z	22	25	19	26

Self-Generated Total Noise ¹				
Weighting	0 dB gain		20 dB gain	
	typical (dB)	max (dB)	Typical (dB)	max (dB)
A	18	19	17	17
C	18	23	17	19
Z	23	26	21	26

¹ Combination of the electronic noise and the thermal noise of the 377B02 microphone at 20° C measured in a sealed cavity and vibration isolated with an averaging time of 60 seconds.

² Electronic noise of the instrument with an ADP090 (12 pF) in place of the microphone.

³ Highest anticipated self-generated noise.

Table B-1: Self-generated Noise Levels

j) Highest Sound Pressure Level

The highest sound pressure level the Larson Davis 831 is designed to accommodate at the level of overload is 140 dB. The peak-to-peak voltage at this level is 28 V_{pp} input through the ADP090.

k) Battery Power Voltage Range

The battery power supply voltage range for which the 831 conform to this standard:

6.4 Volts maximum

The 831 will shut down if the battery is below 4.0 Volts when used with alkaline batteries. Therefore from 4.0 to 6.4 Volts is the usable range of battery voltage. The instrument will shut off to ensure that no data is taken that would not meet the requirements of IEC 61672.

l) Typical Stabilization Time

The typical time interval needed to stabilize after changes in environmental conditions.

For a temperature change of 5 °C then 30 minutes are required.

For a static pressure change of 5 kPa then 15 seconds are required.

For a humidity change of 30% (non-condensing) then 30 minutes are required.

m) Field Strength > 10 V/m

The Larson Davis model 831 was not measured for field strengths greater than 10 V/m.

n) Radio Frequency Emission

The mode of operation of the 831 that produces the greatest radio frequency emission levels was with the 831 set to run and with an EXC010 (10' microphone extension cable) used to connect the PRM831 to the 831.

o) AC Power and Radio Frequency Susceptibility

The mode of operation of the 831 that produced the greatest measurement susceptibility to A.C. power frequency and radio frequency fields was with the 831 set to run, USB cable attached and with an EXC010 (10' microphone extension cable) between the PRM831 and the 831.

C

*Integrated Level Calculations***Basic Integrated Level Calculations****Equivalent Continuous Sound Level**

The Larson Davis Model 831 calculates equivalent continuous sound levels based on equations from IEC standard 61672-1, Section 3.9 which defines L_{eq} as follows:

Note that the 831 displays the equivalent continuous A-weighted sound pressure level as L_{Aeq} .

Equivalent continuous A-weighted sound pressure level (also average A-weighted sound pressure level) is defined as follows:

$$L_{AT} = L_{AeqT} = 20 \lg \left\{ \left[\left(\frac{1}{T} \right) \int_{t-T}^t P_A^2(\xi) d\xi \right]^{1/2} / P_0 \right\} dB$$

where:

L_{AeqT} is the equivalent continuous A-weighted sound pressure level re 20 μ Pa, determined over a time interval T

ξ is a dummy variable of time integration over the averaging time interval ending at the time of observation t

T is the averaging time interval

$p_A(\xi)$ is the A-weighted sound pressure

p_0 is the reference sound pressure of 20 μ Pa

In the equation, the numerator of the argument of the logarithm is the root-mean-square, frequency-weighted sound pressure level over the averaging time interval T.

Note that the format used by the 831 to display equivalent continuous sound pressure level is $L_{X_{eq}}$ where X is the frequency weighting ($X = A, C$ or Z).

When a frequency weighting other than A is used, the frequency weighting used shall be included explicitly in the title and the formula of the quantity, for example equivalent continuous C-weighted sound pressure level:

$$L_{CT} = L_{C_{eqT}} = 20 \lg \left\{ \left[\left(\frac{1}{T} \right) \int_{t-T}^t P_C^2(\xi) d\xi \right]^{1/2} / P_0 \right\} dB$$

If no frequency weighting is used, the quantity is simply called equivalent continuous sound pressure level.

Time-Weighted Averages

The Larson Davis 831 calculates many time-integrated levels or time-weighted averages (TWA) based on different parameters and time intervals. They are all designed and programmed to perform the equation specified in IEC 61672-1 with allowances for the following:

A, C and Z frequency weighting characteristics

Various interval times, both fixed interval TWAs and variable interval event TWAs

Exchange-rates, or “doubling rates” can be entered that effect certain TWA measurements

Certain TWA measurements include a programmable threshold with only levels above this threshold contributing to the measurement

No attempt is made to meet the IEC 61672-1 requirement to title the TWA by frequency weighting and time interval within the analyzer’s display or report system. The Frequency Weighting and Time Interval are both displayed in the same view to meet this requirement.

The following figure indicates how the requirements are met in the 831.

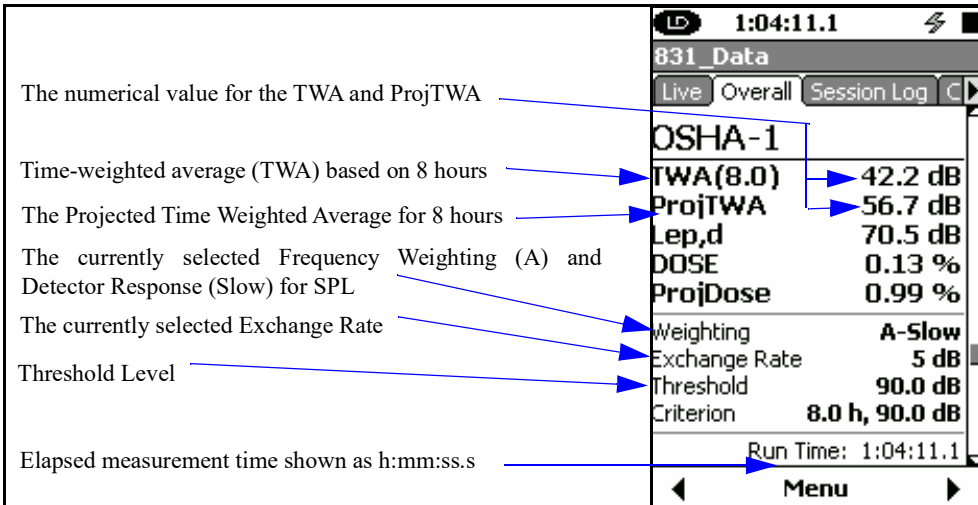

FIGURE C-1 TWA

Note that the 831 displays the time weighted average as TWA[Hr] where Hr is the time in hours over which the average is performed.

The actual equations used within the 831 are based on those for IEC 61672-1 and are implemented according to this equation:

$$L_{TWA} = L_{cal} + k \bullet \log \left(\sum_{s=1}^n 10^{\frac{L_{(s)}}{k}} \right) - \log(n)$$

where:

$L_{(s)}$ is the current SPL at sample s (for measurements that include a threshold, $L_{(s)}$ is set to $-\infty$ if $L_{(s)}$ is less than the Threshold Level L_T)

k is the exchange rate constant which is equal to:

10.00 for an exchange rate of 3 dB (L_{eq})

13.29 for an exchange rate of 4 dB (L_{DOD})

16.61 for an exchange rate of 5 dB (L_{OSHA})

20.00 for an exchange rate of 6 dB (L_{Avg})

n is the total number of samples taken in the measurement. The sample rate is 32 samples per second.

L_{cal} is the calibration offset that corrects for various sensitivities of microphones

SEL Calculations

Note that the 831 displays SEL as L_{XE} , where X is the frequency weighting (X = A, C or Z).

SEL is available for the overall measurement and is calculated using this formula:

$$SEL = L_{cal} + k \cdot \log \left(\sum_{s=1}^n 10^{\frac{L(s)}{k}} \right) - \log(32)$$

All of the SEL energy values in the analyzer utilize the Threshold and Exchange Rate settings. Care should be taken when modifying these settings since some standards or governments require SEL to be taken without a Threshold (set it to zero) and with an Exchange Rate of 3 dB.

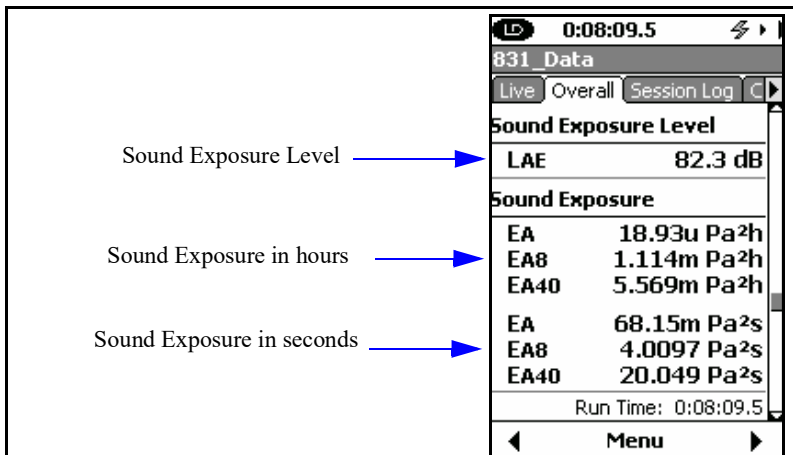

FIGURE C-2 Sound Exposure Level and Sound Exposure

Dose and Projected Dose Calculations

Dose is a measure of Sound Exposure and is defined in ANSI S1.25 Section 4.7 as:

$$D(Q) = \left(\frac{100}{T_c}\right) \cdot \int_0^T 10^{\left(\frac{L-L_c}{q}\right)} dt$$

See FIGURE C-3 "DOSE and Projected DOSE"

where:

$D(Q)$ is the percentage criterion exposure for exchange rate Q

T_c is the criterion sound duration = 8 hours

T is the measurement duration in hours

t is the time in hours

L is the SLOW, (or FAST) A-weighted sound level, a function of time, when the sound level is greater than or equal to L_t , or equals $-x$ when the A-weighted sound level is less than L_t

L_t is the threshold sound level specified by the manufacturer

L_c is the criterion sound level specified by the manufacturer

Q is the exchange rate in dB, and q = the parameter that determines the exchange rate, where:

$q = 10$ for a 3 dB exchange rate

$q = 13.29 = 4/\log(2)$ for a 4 dB exchange rate

$q = 16.61 = 5/\log(2)$ for a 5 dB exchange rate

$q = 20 = 6/\log(2)$ for a 6 dB exchange rate

The factor of 100 in the equation produces a result that is a percentage.

Dose is obtained from the accumulations made for TWA and SEL using the formula:

where,

$L_{(s)}$ is the current SPL at sample s ; for measurements that include a threshold $L_{(s)}$ is set to \times if $L_{(s)}$ is less than the Threshold Level L_t

$$DOSE = 10 \left[\log \left(\sum_{s=1}^n 10^{\frac{L_{(s)}}{k}} \right) - \frac{L_c}{k} - \log(T_c 115200) + \log(100) \right] \%$$

k is the exchange rate constant. See the explanation for “ q ” on the previous page.

n is the total number of samples taken in the measurement. The sample rate is 32 samples per second.

T_c is the criterion sound duration as set by the 831’s “Criterion Time Hours” setting which by default is set to 8 hours L_c is the criterion sound level as set by the 831’s “Overall Criterion” or “Current Criterion” settings.

Addition of the term “ $\log(100)$ ” was used to implement the 100 multiplier of the ANSI equation that creates the percentage. Subtracting the log of the Criterion Time was used to implement the division of Criterion Time of the ANSI equation.

Projected Dose in the analyzer is obtained with an equation similar to that of Dose except that the actual duration (time) of the measurement is used rather than a Criterion Time, as thus:

$$PROJDOSE = 10 \left[\log \left(\sum_{s=1}^n 10^{\frac{L_{(s)}}{k}} \right) - \frac{L_c}{k} - \log(n) + \log(100) \right] \%$$

where the $\log(n)$ is the actual time factor, n being the total number of samples taken.

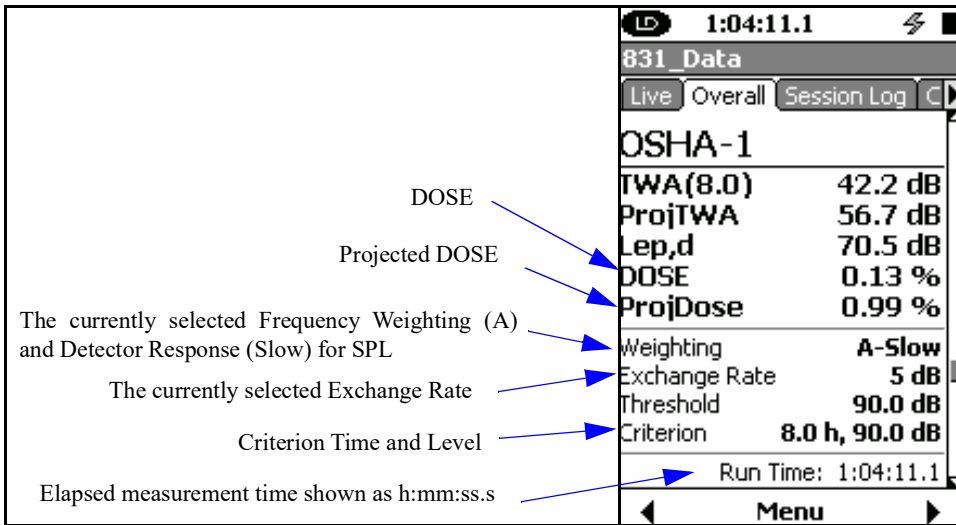

FIGURE C-3 DOSE and Projected DOSE

Sound Exposure Calculations

Sound exposure and sound exposure level are calculated as specified in IEC 61672-1.

Note that the 831 displays Sound Exposure as E_X , where X is the frequency weighting (X=A, C or Z).

Sound Exposure

See FIGURE C-2 "Sound Exposure Level and Sound Exposure"

The A-weighted sound exposure E_A of a specified event is represented by

$$E_A = \int_{t_1}^{t_2} p_A^2(t) dt$$

where $P_A^2(t)$ is the square of the A-weighted instantaneous sound pressure during an integration time starting at t_1 and ending at t_2 .

The unit of A-weighted sound exposure is pascal-squared seconds if A-weighted sound pressure is in pascals and running time is in seconds. However it is sometimes

expressed in pascal-squared hours for measurements of noise exposure in the workplace.

Note that the 831 displays Sound Exposure Level as L_{XE} , where X is the frequency weighting (X=A, C or Z).

Sound Exposure Level

The A-weighted sound exposure level L_{AE} is related to a corresponding measurement of time-average, A-weighted sound level, L_{AT} or L_{AEeqT} , by

$$L_{AE} = 10 \lg \left\{ \left[\int_{t_1}^{t_2} p_A^2(t) dt \right] / (p_0^2 T_0) \right\} dB = 10 \lg (E_A / E_0) dB = L_{AT} + 10 \lg (T / T_0) dB$$

where

E_A is the A-weighted sound exposure in pascal-squared seconds

E_0 is the reference sound exposure of:

$$(20 \mu\text{Pa})^2 \times 1\text{s} = 400 \times 10^{-12} \text{ Pa}^2\text{s}$$

$$T_0 = 1 \text{ s}$$

$T = t_2 - t_1$, the time interval for measurement, in seconds, for sound exposure level and time-average sound level

Community Noise Descriptors

L_{DN}

The day-night level L_{DN} is defined by the following formula:

$$L_{DN} = 10 \cdot \log_{10} \left[\frac{1}{H_D + H_N} \cdot \left(H_D \cdot 10^{\frac{L_{day}}{10}} + H_N \cdot 10^{\frac{L_{night} + L_{PN}}{10}} \right) \right]$$

Where:

- H_D is the number of hours programmed for "daytime",
- H_N is the number of hours programmed for "nighttime",
- L_{day} is the equivalent level measured during the daytime period,
- L_{night} is the equivalent level measured during the nighttime period
- L_{PN} is the nighttime penalty level, generally 10dB.

In the default form, the day has sixteen hours ($H_D = 16$) and the night has eight hours ($H_N = 8$). The defined time periods for Day and Night times are programmed the same as L_{DEN} . Default time periods are shown below.

Generally L_{DN} is only defined for full 24 hour periods. If the measurement did not last for the entire 24 hours (or more), the level measured for any partial portion of the day or night period is assumed to represent the entire period. If there was no measurement performed for either the day or night time period then the number of hours used in the formula is set to zero and the corresponding L_{day} or L_{night} will be shown as "- -". The Session Log and Run Time are used to qualify the measurement periods.

L_{DEN}

The day-evening-night level L_{DEN} is defined by the following formula:

$$L_{DEN} = 10 \cdot \log_{10} \left[\frac{1}{H_D + H_E + H_N} \cdot \left(H_D \cdot 10^{\frac{L_{day}}{10}} + H_E \cdot 10^{\frac{L_{evening} + L_{PE}}{10}} + H_N \cdot 10^{\frac{L_{night} + L_{PN}}{10}} \right) \right]$$

Where:

- H_D is the number of hours programmed for the "day" period,
- H_E is the number of hours programmed for "evening" period,
- H_N is the number of hours programmed for "night" period,
- L_{day} is the equivalent level measured during the daytime period,
- L_{night} is the equivalent level measured during the nighttime period,
- L_{PE} is the evening penalty level, generally 5dB (4.7dB for CNEL) and
- L_{PN} is the nighttime penalty level, generally 10 dB.

In the default form, the day has twelve hours (H_D = 12), evening has four hours (H_E = 4) and the night has eight hours (H_N = 8). In the default form, the day has eight hours, the evening has four hours and the night has eight hours, as can be seen in the equation. The default times for these periods are as follows:

- Day: 0700 to 1900
- Evening: 1900 to 2300
- Night: 2300 to 0700

L_{day}, L_{evening} and L_{night} are A-weighted long-term average sound levels measured during the day, evening and night, respectively

Generally L_{DEN} is only defined for full 24 hour periods. If the measurement did not last for the entire 24 hours (or more), the level measured for any partial portion of the day, evening or night period is assumed to represent the entire period. If there was no measurement performed for any of

the day, evening or night time periods then the number of hours used in the formula is set to zero and the corresponding L_{day} , $L_{evening}$ or L_{night} will be shown as "- -". The Session Log and Run Time are used to qualify the measurement periods.

CNEL

In the state of California, a commonly used community noise descriptor is Community Noise Equivalent Level (CNEL), defined by the following formula:

$$CNEL = 10 \log_{10} \left\{ \frac{1}{24} \left[\sum_{0000}^{0700} 10^{(L_i + 10)/10} + \sum_{0700}^{1900} 10^{L_i/10} + \sum_{1900}^{2200} 10^{(L_i + 5)/10} + \sum_{2200}^{2400} 10^{(L_i + 10)/10} \right] \right\}$$

This is essentially the same as the L_{DEN} using default values, with the exception that the evening period begins at 22.00 instead of 23.00. Thus, by making this change in the L_{DEN} formula, the measured value will represent CNEL.

D

Glossary

This appendix contains technical definitions of key acoustical and vibration terms commonly used with Larson Davis instruments. The reader is referred to American National Standards Institute document S1.1-1994 (R2004) for additional definitions. Specific use of the terms defined are in the main body of the text.

Allowed Exposure Time (T_i)

It is the allowed time of exposure to sound of a constant A-weighted sound level given a chosen Criterion Level, Criterion Duration, and Exchange Rate. The equation for it is

$$T_i = \frac{T_c}{2^{(L_{avg} - L_c)/Q}} = \frac{T_c}{10^{(L_{avg} - L_c)/q}}$$

where L_c is the Criterion Level, T_c is the Criterion Duration, Q is the Exchange Rate, q is the Exchange Rate Factor and L_{avg} is the Average Sound Level.

Example: If $L_c = 90$, $T_c = 8$, $Q = 3$ and $L_{ave} = 95$ then

$$T_i = \frac{8}{2^{(95-90)/3}} = \frac{8}{10^{(95-90)/10}} = 2.52 = 2 \text{ hours and 31 minutes}$$

This means that if a person is in this area for 2 hours and 31 minutes he will have accumulated a Noise Dose of 100%.

Standard: ANSI S12.19.

The table for Exchange Rate (Q), Exchange Rate Factor (q) and Exposure Factor is shown in the section Exchange Rate (Q), Exchange Rate Factor (q), Exposure Factor (k) on page D-7.

Average Sound Level (L_{avg})

It is the logarithmic average of the sound during a Measurement Duration (specific time period), using the chosen Exchange Rate Factor. Exposure to this sound level over the period would result in the same noise dose and the actual (unsteady) sound levels. If the Measurement Duration is the same as the Criterion Duration, then $L_{avg} = L_{TWA(LC)}$

where the Measurement Duration (specified time period) is $T = T_2 - T_1$ and q is the Exchange Rate Factor. Only sound

$$L_{avg} = q \text{Log}_{10} \left(\frac{1}{T} \int_{T_1}^{T_2} 10^{(L_p(t))/q} dt \right)$$

levels above the Threshold Level are included in the integral. *Standard:* ANSI S12.19

Community Noise Equivalent Level (CNEL, L_{den})

A rating of community noise exposure to all sources of sound that differentiates between daytime, evening and nighttime noise exposure. The equation for it is

$$L_{den} = 10 \log_{10} \left\{ \frac{1}{24} \left[\sum_{0000}^{0700} 10^{(L_i+10)/10} + \sum_{0700}^{1900} 10^{L_i/10} + \sum_{1900}^{2200} 10^{(L_i+5)/10} + \sum_{2200}^{2400} 10^{(L_i+10)/10} \right] \right\}$$

The continuous equivalent sound level is generally calculated on an hourly basis and is shown in the equation as L. The levels for the hourly periods from midnight to 7 a.m. have 10 added to them to represent less tolerance for noise during sleeping hours. The same occurs from 10 p.m. to midnight. The levels for the hourly periods between 7 p.m. and 10 p.m. have 5 added to them to represent a lessened tolerance for noise during evening activities. They are energy summed and converted to an average noise exposure rating.

Criterion Duration (T_c)

It is the time required for a constant sound level equal to the Criterion Level to produce a Noise Dose of 100%. Criterion Duration is typically 8 hours.

Example: If the Criterion Level = 90 dB and the Criterion Duration is 8 hours, then a sound level of 90 dB for 8 hours, will produce a 100% Noise Dose. See Noise Dose. *Standard:* ANSI S12.19

Criterion Sound Exposure (CSE)

The product of the Criterion Duration and the mean square sound pressure associated with the Criterion Sound Level when adjusted for the Exchange Rate. It is expressed in Pascals-squared seconds when the exchange rate is 3 dB. where q is the Exchange Rate Factor. See Exchange Rate.

$$CSE = T_c 10^{L_c/q}$$

Standard: ANSI S1.25

Criterion Sound Level (L_c)

It is the sound level which if continually applied for the Criterion Duration will produce a Noise Dose of 100%. The current OSHA Criterion Level is 90 dB.

Standard: ANSI S12.19

Daily Personal Noise Exposure (L_{EP,d})

It is the level of a constant sound over the Criterion Duration that contains the same sound energy as the actual, unsteady sound over a specific period. The period is generally shorter, so the sound energy is spread out over the Criterion Duration period.

Example: If the Criterion Duration = 8 hours and the specific period is 4 hours and the average level during the 4 hours is 86 dB, then the L_{EP,d} = 83 dB.

Day-Night Average Sound Level (DNL, L_{dn})

A rating of community noise exposure to all sources of sound that differentiates between daytime and nighttime noise exposure. The equation for it is

$$L_{dn} = 10 \text{Log}_{10} \left\{ \frac{1}{24} \left[\sum_{0000}^{0700} 10^{(L_i + 10)/10} + \sum_{0700}^{2200} 10^{L_i/10} + \sum_{2200}^{2400} 10^{(L_i + 10)/10} \right] \right\}$$

The continuous equivalent sound level (See definition) is generally calculated on an hourly basis and is shown in the equation as L.

The values for the hourly periods from midnight to 7 a.m. have 10 added to them to represent less tolerance for noise

during sleeping hours. The same occurs from 10 p.m. to midnight. They are energy summed and converted to an average noise exposure rating.

Decibel (dB)

A logarithmic form of any measured physical quantity and commonly used in the measurement of sound and vibration. Whenever the word *level* is used, this logarithmic form is implied. The decibel provides us with the possibility of representing a large span of signal levels in a simple manner as opposed to using the basic unit Pascal for acoustic measurements.

It is not possible to directly add or subtract physical quantities when expressed in decibel form since the addition of logarithmic values correspond to multiplication of the original quantity.

The word *level* is normally attached to a physical quantity when expressed in decibels; for example, L_p represents the sound pressure level.

The difference between the sound pressure for silence versus loud sounds is a factor of 1,000,000:1 or more, and it is very unpractical to use these large numbers. Therefore, a measure that would relate to “the number of zeros” would help, for example, 100,000 would be equal to 50 and 1000 would be equal to 30 and so on. This is the basic principal of the dB measure.

All dB values are unit free and therefore, the dB value is not the value of the quantity itself, but the ratio of that quantity to an actual reference quantity used. Thus, for every level in decibels there must be a well defined reference quantity. Sound versus vibration uses different references, but the dB principal is the same. When the quantity equals the reference quantity the level is zero. To keep dB values above zero, the reference is generally set to be the lowest value of the quantity that we can imagine or normally wish to use. Before explaining the calculation of dB values, it is useful to remember the following rules of thumb when dB values are used for sound levels:

- Doubling of the Sound Pressure = 6 dB
- Doubling of the Sound Power = 3 dB
- Doubling of the Perceived Sound Level = (approx) 10 dB

Note: The latter is frequency and level dependent, but the value “10 dB” is a good rule of thumb, especially around 1 kHz.

Table 1 shows the actual value of a specific item, such as sound power, for which the sound level is calculated. First, the sound power value is divided with the reference used and then the ten-based logarithm is applied. This value is then multiplied by 10 to create the decibel value (see equation D-1 below).

For every 10 decibels, a unit called Bel is created. The decibel stands for: *deci* for “one tenth” and *bel* for “Bel” (compare decimeter). The relationship between Bel and decibel is thus: 1 Bel = 10 decibels. It is not possible to directly add or subtract decibel values, since addition of logarithmic values correspond to multiplication of the original quantity.

Table 1		
Power form, squared units		Level form
Ration of Value to Reference	Exponential Form of Ratio	10•Exponent
1	10^0	0
10	10^1	10
100	10^2	20
200	$10^{2.3}$	23
1,000	10^3	30
10,000	10^4	40
100,000	10^5	50
1000,000	10^6	60

Each time the sound *pressure* level increases by 6 dB, the corresponding sound *pressure* value is doubled and thus multiplied by 2. Each time the sound *power* level increases by 3 dB, the sound *power* value is multiplied by 2. Thus, it is important to notice that a doubling of the *sound power* is equal to 3 dB, and a doubling of the sound pressure is equal to 6 dB, since a doubling of the sound pressure will result in a quadruple increase of the sound power. The advantage with using dB is simply that they remain the same even if we use sound pressure or sound power. Compare this to the use of voltage and power units in electrical engineering, units being related by $P \sim V^2$. In table 2 an illustration is made of values calculated on sound pressure, non-squared units.

The original definition of decibel was intended for power-like quantities, such as sound power. If we consider sound pressure levels instead (usually denoted P in acoustics), the equation will be the same, since the “two” in the squared units will move from within the bracket and become a $20 \log$ instead of a $10 \log$ and thus compensate for using linear or quadratic units. Please note that it is not allowed to use $20 \log$ for squared units, since that expression assumes that we use linear units, like sound pressure in acoustics or voltage in electrical engineering. This is illustrated in equation D-1 below:

$$dB = 10 \text{Log}_{10} \left[\frac{P^2}{P_0^2} \right] = 20 \text{Log} \left[\frac{P}{P_0} \right] \quad ; p_0 = 20 \mu Pa$$

Table 2 illustrates how a tenfold increase of the sound pressure will result in an increase in 20 dB steps, while sound power increases in 10 dB steps. See the linear form (Table 2) and compare with equation D-1. In conclusion, dB values are always the same, independent of using sound power or sound pressure as the base unit. A 6 dB increase implies four times the sound power or two times the sound pressure.

Table 2		
Linear form, non-squared units		Level form
Ration of Value to Reference	Exponential Form of Ratio	20•Exponent
1	10^0	0
10	10^1	20
100	10^2	40
200	$10^{2.3}$	46
1,000	10^3	60
10,000	10^4	80
100,000	10^5	100
1000,000	10^6	120

Department of Defense Level (L_{DOD})

The Average Sound Level calculated in accordance with Department of Defense Exchange Rate and Threshold Level. See Average Sound Level

Dose

(See Noise Dose)

Detector

The part of a sound level meter that converts the actual fluctuating sound or vibration signal from the microphone to one that indicates its amplitude. It first squares the signal, then averages it in accordance with the time-weighting characteristic, and then takes the square root. This results in an amplitude described as rms (root-mean-square).

Eight Hour Time-Weighted Average Sound Level (L_{TWA(8)})

It is the constant sound level that would expose a person to the same Noise Dose as the actual (unsteady) sound levels. The equation for it is

$$L_{TWA(8)} = L_c + q \text{Log}_{10} \left(\frac{D}{100} \right)$$

NOTE: This definition applies only for a Criterion Duration of 8 hours.

Standard: ANSI S12.19

Energy Equivalent Sound Level (L_{eq})

The level of a constant sound over a specific time period that has the same sound energy as the actual (unsteady) sound over the same period.

$$L_{eq} = 10 \text{Log}_{10} \left[\frac{\int_{T_1}^{T_2} p^2(t) dt}{p_o^2 T} \right]$$

where p is the sound pressure and the Measurement Duration (specific time period) T=T₂-T₁. See Sound Exposure Level.

Exchange Rate (Q), Exchange Rate Factor (q), Exposure Factor (k)

It is defined in ANSI S1.25 as “the change in sound level corresponding to a doubling or halving of the duration of a sound level while a constant percentage of criterion exposure is maintained.” The rate and the factors are given

in the table below.
Standard: ANSI S12.19

Exchange Rate, Q	Exchange Rate Factor, q	Exposure Factor, k
3.01	10	1
4	13.29	.75
5	16.61	.60
6.02	20	.50

Far Field

There are two types of far fields: the *acoustic* far field and the *geometric* far field.

Acoustic Far Field: The distance from a source of sound is greater than an acoustic wavelength. In the far field, the effect of the type of sound source is negligible. Since the wavelength varies with frequency (See the definition of Wavelength), the distance will vary with frequency. To be in the far field for all frequencies measured, the lowest frequency should be chosen for determining the distance. For example, if the lowest frequency is 20 Hz, the wavelength at normal temperatures is near 56 ft. (17 m); at 1000 Hz, the wavelength is near 1.1 ft. (1/3 m). See the definition of Acoustic Near Field for the advantages of being in the acoustic far field.

Geometric Far Field: The distance from a source of sound is greater than the largest dimension of the sound source. In the far field, the effect of source geometry is negligible. Sound sources often have a variety of specific sources within them, such as exhaust and intake noise. When in the far field, the sources have all merged into one, so that measurements made even further away will be no different. See the definition of Geometric Near Field for the advantages of being in the geometric far field.

Free Field

A sound field that is *free* of reflections. This does not mean that the sound is all coming from one direction as is often assumed, since the source of sound may be spatially extensive. See the definitions of near and far fields for more detail. This definition is often used in conjunction with reverberant field.

Frequency (Hz, rad/sec)

The rate at which an oscillating signal completes a complete cycle by returning to the original value. It can be expressed in cycles per second and the value has the unit symbol Hz (Hertz) added and the letter f is used for a universal descriptor. It can also be expressed in radians per second,

which has no symbol, and the greek letter ω is used for a universal descriptor. The two expressions are related through the expression $\omega=2\pi f$.

Frequency Band Pass Filter

The part of certain sound level meters that divides the frequency spectrum on the sound or vibration into a part that is unchanged and a part that is filtered out. It can be composed of one or more of the following types:

Low Pass: A frequency filter that permits signals to pass through that have frequencies below a certain fixed frequency, called a *cutoff frequency*. It is used to discriminate against higher frequencies.

High Pass: A frequency filter that permits signals to pass through that have frequencies above a certain fixed frequency, called a *cutoff frequency*. It is used to discriminate against lower frequencies.

Bandpass: A frequency filter that permits signals to pass through that have frequencies above a certain fixed frequency, called a lower cutoff frequency, and below a certain fixed frequency, called an *upper cutoff frequency*. The difference between the two cutoff frequencies is called the *bandwidth*. It is used to discriminate against both lower and higher frequencies so it passes only a band of frequencies.

Octave band: A bandpass frequency filter that permits signals to pass through that have a bandwidth based on octaves. An *octave* is a doubling of frequency so the upper cutoff frequency is twice the lower cutoff frequency. This filter is often further subdivided in 1/3 and 1/12 octaves (3 and 12 bands per octave) for finer frequency resolution. Instruments with these filters have a sufficient number of them to cover the usual range of frequencies encountered in sound and vibration measurements. The frequency chosen to describe the band is that of the center frequency. Note table in Frequency Filter - Frequency Weighting.

Frequency Filter - Weighted

A special frequency filter that adjusts the amplitude of all parts of the frequency spectrum of the sound or vibration unlike band pass filters. It can be composed of one or more of the following types:

A-Weighting: A filter that adjusts the levels of a frequency spectrum in the same way the human ear does when exposed to low levels of sound. This weighting is most often used for

evaluation of environmental sounds. See table below.

B-Weighting: A filter that adjusts the levels of a frequency spectrum in the same way the human ear does when exposed to higher levels of sound. This weighting is seldom used. See table below.

C-Weighting: A filter that adjusts the levels of a frequency spectrum in the same way the human ear does when exposed to high levels of sound. This weighting is most often used for evaluation of equipment sounds. See table below.

Flat-Weighting: A filter that does not adjust the levels of a frequency spectrum. It is sometimes an alternative selection for the frequency-weighting selection.

Z-Weighting: Similar to a flat-weighting curve, this is a bandpass filter with a passband from 10 Hz to 20 kHz.

Center Frequencies, Hz		Weighting Network Frequency Response		
1/3 Octave	1 Octave	A	B	C
20		-50.4	-24.2	-6.2
25		-44.7	-20.4	-4.4
31.5	31.5	-39.4	-17.1	-3.0
40		-34.6	-14.2	-2.0
50		-30.2	-11.6	-1.3
63	63	-26.2	-9.3	-0.8
80		-22.5	-7.4	-0.5
100		-19.1	-5.6	-0.3
125	125	-16.1	-4.2	-0.2
160		-13.4	-3.0	-0.1
200		-10.9	-2.0	0

Center Frequencies, Hz		Weighting Network Frequency Response		
1/3 Octave	1 Octave	A	B	C
250	250	-8.6	-1.3	0
315		-6.6	-0.8	0
400		-4.8	-0.5	0
500	500	-3.2	-0.3	0
630		-1.9	-0.1	0
800		-0.8	0	0
1000	1000	0	0	0
1250		0.6	0	0
1600		1.0	0	-0.1
2000	2000	1.2	-0.1	-0.2
2500		1.3	-0.2	-0.3
3150		1.2	-0.4	-0.5
4000	4000	1.0	-0.7	-0.8
5000		0.5	-1.2	-1.3
6300		-0.1	-1.9	-2.0
8000	8000	-1.1	-2.9	-3.0
10000		-2.5	-4.3	-4.4
12500		-4.3	-6.1	-6.2
16000	16000	-6.6	-8.4	-8.5
20000		-9.3	-11.1	-11.2

L_{eq}

See “Energy Equivalent Sound Level”, “Sound Level”, “Energy Average”, and “Time Weighted Average”

Level (dB)

A descriptor of a measured physical quantity, typically used in sound and vibration measurements. It is attached to the name of the physical quantity to denote that it is a logarithmic measure of the quantity and not the quantity itself. The word *decibel* is often added after the number to express the same thing. When frequency weighting is used the annotation is often expressed as dB(A) or dB(B).

Measurement Duration (T)

The time period of measurement. It applies to hearing damage risk and is generally expressed in hours.

Standard: ANSI S12.19

Microphone Guidelines

Microphone - Types: A device for detecting the presence of sound. Most often it converts the changing pressure associated with sound into an electrical voltage that duplicates the changes. It can be composed of one of the following types:

Capacitor (Condenser): A microphone that uses the motion of a thin diaphragm caused by the sound to change the capacitance of an electrical circuit and thereby to create a

signal. For high sensitivity, this device has a voltage applied across the diaphragm from an internal source.

Electret: A microphone that uses the motion of a thin diaphragm caused by the sound to change the capacitance of an electrical circuit and thereby to create a signal. The voltage across the diaphragm is caused by the charge embedded in the electret material so no internal source is needed.

Microphone - Uses: The frequency response of microphones can be adjusted to be used in specific applications. Among those used are:

Frontal incidence (Free Field): The microphone has been adjusted to have an essentially flat frequency response when in a space relatively free of reflections and when pointed at the source of the sound.

Random incidence: The microphone has been adjusted to have an essentially flat frequency response for sound waves impinging on the microphone from all directions.

Pressure: The microphone has not been adjusted to have an essentially flat frequency response for sound waves impinging on the microphone from all directions.

What a microphone measures: *A microphone detects more than just sound.* The motion of a microphone diaphragm is in response to a force acting on it. The force can be caused by a number of sources only one of which are we interested: sound. Non-sound forces are: (1) direct physical contact such as that with a finger or a raindrop; (2) those caused by the movement of air over the diaphragm such as environmental wind or blowing; (3) those caused by vibration of the microphone housing; and (4) those caused by strong electrostatic fields.

Rules:

1. Do not permit any solid or liquid to touch the microphone diaphragm. Keep a protective grid over the diaphragm.
2. Do not blow on a microphone and use a wind screen over the microphone to reduce the effect of wind noise.
3. Mount microphones so their body is not subject to vibration, particularly in direction at right angles to the plane of the diaphragm.
4. Keep microphones away from strong electrical fields.

A microphone measures forces not pressures. We would like the microphone to measure sound pressure (force per unit area) instead of sound force. If the pressure is applied

uniformly over the microphone diaphragm a simple constant (the diaphragm area) relates the two, but if the pressure varies across the diaphragm the relationship is more complex. For example, if a negative pressure is applied on one-half the diaphragm and an equal positive pressure is applied to the other half, the net force is zero and essentially no motion of the diaphragm occurs. This occurs at high frequencies and for specific orientations of the microphone.

Rules:

1. Do not use a microphone at frequencies higher than specified by the manufacturer; to increase the frequency response choose smaller microphones.
2. Choose a microphone for *free field* or *random incidence* to minimize the influence of orientation.

A microphone influences the sound being measured. The microphone measures very small forces, low level sound can run about one-billionth of a PSI! Every measurement instrument changes the thing being measured, and for very small forces that effect can be significant. When sound impinges directly on a microphone the incident wave must be reflected since it cannot pass through the microphone. This results in the extra force required to reflect the sound and a microphone output that is higher than would exist if the microphone were not there. This is more important at high frequencies and when the microphone is facing the sound source.

Rules:

1. Do not use a microphone at frequencies higher than specified by the manufacturer; to increase the frequency response choose smaller microphones.
2. Choose a microphone for *free field* or *random incidence* to minimize the influence of orientation.

A microphone measures what is there from any direction: Most measurements are intended to measure the sound level of a specific source, but most microphones are not directional so they measure whatever is there, regardless of source.

Rules:

1. When making hand-held measurements, keep your body at right angles to the direction of the sound you are interested in and hold the meter as far from your body as possible. Use a tripod whenever possible.
2. Measure the influence of other sources by measuring the background sound level without the source of interest. You may have to correct for the background.

Near Field

There are two types of near fields: the *acoustic near field* and the *geometric near field*.

Acoustic Near Field: The distance from a source of sound is less than an acoustic wavelength. In the near field, the effect of the type of sound source is significant. Since the wavelength varies with frequency (See the definition of Wavelength), the distance will vary with frequency. The most common example of a near field is driving an automobile with an open window. As you move your ear to the plane of the window, the sound pressure level builds up rapidly (wind noise) since most of the pressure changes are to move the air and very little of it compresses the air to create sound. Persons not far away, can hardly hear what you hear. The acoustic near field is characterized by pressures that do not create sound that can be measured in the far field. Therefore measurements made here are not useful in predicting the sound levels far away or the sound power of the source.

Geometric Near Field: The distance from a source of sound is less than the largest dimension of the sound source. In the near field, effect of source geometry is significant. Sound sources often have a variety of specific sources within them, such as exhaust and intake noise. When in the near field, the sound of a weaker, but close, source can be louder than that of a more distant, but stronger, source. Therefore measurements made here can be used to separate the various sources of sound, but are not useful in predicting the sound levels and sound spectrum far from the source.

Noise

Typically it is *unwanted* sound. This word adds the response of humans to the physical phenomenon of sound. The descriptor should be used only when negative effects on people are known to occur. Unfortunately, this word is used also to describe sounds with no tonal content (random):

Ambient: The all encompassing sound at a given location caused by all sources of sound. It is generally random, but need not be.

Background: The all encompassing sound at a given location caused by all sources of sound, but the source to be measured. It is essentially the sound that interferes with a measurement.

Pink: It is a random sound that maintains constant energy per octave. Pink light is similar to pink noise in that it has a higher level at the lower frequencies (red end of the

spectrum).

White: It is a random sound that contains equal energy at each frequency. In this respect, it is similar to white light.

Noise Dose (D)

It is the percentage of time a person is exposed to noise that is potentially damaging to hearing. Zero represents no exposure and 100 or more represents complete exposure. It is calculated by dividing the actual time of exposure by the allowed time of exposure. The allowed time of exposure is determined by the Criterion Duration and by the sound level (the higher the level, the shorter the allowed time). The sound levels must be measured with A-frequency weighting and slow exponential time weighting. See Projected Noise Dose.

$$D = \frac{100T}{T_c} 10^{(L_i - L_c)/q}$$

where

T is Measurement Duration

T_c is Criteria Time

L_i is TWA

L_c is Criteria Level

q is exchange rate factor; see page D-7 "Exchange Rate (Q), Exchange Rate Factor (q), Exposure Factor (k)"

Standard: ANSI S12.19

Noise Exposure

(See Sound Exposure)

OSHA Level (L_{OSHA})

The Average Sound Level calculated in accordance with the Occupational Safety and Health Administration Exchange Rate and Threshold Level.

Preamplifier

A part of the sound level meter that matches a particular model of microphone to the meter. It must be chosen in conjunction with a microphone and a cable that connects them.

Projected Noise Dose

It is the Noise Dose expected if the current rate of noise exposure continues for the full Criterion Duration period.

Single Event Noise Exposure Level (SENEL, L_{AX})

The total sound energy over a specific period. It is a special form of the Sound Exposure Level where the time period is defined as the start and end times of a noise event such as an aircraft or automobile passing by.

Sound

The rapid oscillatory compressional changes in a medium (solid, liquid or gas) that propagate to distant points. It is characterized by changes in density, pressure, motion, and temperature as well as other physical quantities. Not all rapid changes in the medium are sound (wind noise) since they do not propagate.

The auditory sensation evoked by the oscillatory changes.

Difference between sound and noise: Sound is the physical phenomenon associated with acoustic (small) pressure waves. Use of the word *sound* provides a neutral description of some acoustic event. Generally, noise is defined as unwanted sound. It can also be defined as sound that causes adverse effects on people such as hearing loss or annoyance. It can also be defined as the sound made by other people. In every case, use of the term noise involves someone's judgment. This often puts noise in the realm of psychology not physics.

Sound Exposure (E)

It is the total sound energy of the actual sound during a specific time period. It is expressed in Pascals-squared seconds.

$$E = \int_{T_1}^{T_2} p_A^2(t) dt$$

where p_A is the sound pressure and $T_2 - T_1$ is the Measurement Duration (specific time period).

When applied to hearing damage potential, the equation is changed to

$$E = \int_{T_1}^{T_2} [p_A^2(t)]^k dt$$

where k is the Exposure Factor. See Exchange Rate.
Standard: ANSI S1.25

Sound Exposure Level (SEL, L_E)

The total sound energy in a specific time period, as calculated using the following formula.

$$SEL = 10 \text{Log}_{10} \left[\frac{\int_{T_1}^{T_2} p^2(t) dt}{p_0^2 T} \right]$$

The sound pressure is squared and integrated over a specific period of time (T₂-T₁) to calculate the sound exposure. It's expressed in Pascal squared-seconds or Pascal squared-hours. P₀ is the reference pressure of 20 μPa. T is the reference time of 1 second. It is then put into logarithmic form. Please note that this is not an average, since the reference time is not the same as the integration time.

Sound Pressure

The physical characteristic of sound that can be detected by microphones. Not all pressure signals detected by a microphone are sound (e.g., wind noise). It is the amplitude of the oscillating sound pressure and is measured in Pascals (Pa), Newtons per square meter, which is a metric equivalent of pounds per square inch. To measure sound, you must separate the oscillating pressure from the steady (barometric) pressure. To do this, we measure sound by using a detector. The detector removes the steady pressure, so that only the oscillating pressure remains. You then square the pressure, take the time average, and take the square root (this is called rms for root-mean square). This can be done by applying a **Moving Average** or a **Fixed Average**.

Moving Average: The averaging process is continually accepting new data so it is similar to an exponential moving average. The equation for it is

$$P_{rms} = \sqrt{\frac{1}{T} \int_{t_s}^t p^2(\xi) e^{-(t-\xi)/T} d\xi}$$

The sound pressure is squared and multiplied by a exponential decay factor so that when the time of integration is near the current time (t) it is essentially undiminished. For times older (less) than the current time, the value is diminished and so becomes less important. The rate at which older data are made less influential is expressed by the constant T. The larger it is, the slower the decay factor reduces and the slower the response of the system to rapid changes. These are standardized into three values called Time Weighting. See the values below.

Fixed Average: The averaging process is over a fixed time period. The equation for it is

$$P_{rms} = \sqrt{\frac{1}{(T_2 - T_1)} \int_{T_1}^{T_2} p^2(t) dt}$$

The sound pressure is squared and averaged over a fixed time period. Unlike the moving average, the sound pressures in all time intervals are equally weighted.

Sound Pressure Level (SPL, L_p)

The logarithmic form of sound pressure. It is also expressed by attachment of the word decibel to the number. The logarithm is taken of the ratio of the actual sound pressure to a reference sound pressure which is 20 MicroPascals (μ Pa). There are various descriptors attached to this level depending on how the actual sound pressure is processed in the meter:

Instantaneous: The time varying reading on a meter face on in a meter output due to changes in the sound pressure. The reading will depend on the time-weighting applied.

The fundamental relationship between the two is logarithmic

$$L_p = 20 \log_{10} \left[\frac{p_{rms}}{p_0} \right] \quad p_{rms} = p_0 10^{L_p/20}$$

where p_0 is the reference sound pressure of 20 μ Pa. The square of the sound pressure is a power-like quantity that can be expressed in the original form of the level definition

$$L_p = 10 \log_{10} \left[\frac{p_{rms}^2}{p_0^2} \right] \quad p_{rms}^2 = p_0^2 10^{L_p/10}$$

Sound Pressure Level can be converted to sound pressure as follows. If the sound pressure is 1 Pascal, then the sound pressure level is

$$L_p = 20 \log_{10} \left[\frac{1}{20 \bullet 10^{-6}} \right] = 20 \log_{10} [50000] = 20 [4.699] = 94.0 \text{ dB}$$

Calibrators often use a level of 94 dB so they generate a sound pressure of 1 Pascal.

If the sound pressure level = 76.3 dB, then the sound pressure is

$$Pa = 20 \bullet 10^{-6} \bullet 10^{76.3/20} = 20 \bullet 10^{3.815 - 6} = 20 \bullet 10^{-2.185} = 20 [0.0065] = 0.13$$

Energy Average (L_{eq}): The value of a steady sound measured over a fixed time period that has the same sound energy as the actual time varying sound over the same period. This descriptor is widely used. It is a fixed average (See Sound Pressure).

Impulse: The value of an impulsive sound. The reading will depend on the time-weighting applied.

Unweighted Peak: The peak value of a sound with a meter that has flat frequency weighting and a peak detector.

Weighted Peak: The peak value of a sound with a meter that has a frequency weighting other than flat and a peak detector.

Sound Power(W)

The sound power emitted by a sound source. It is measured in Watts.

Sound Power Level (PWL, L_w)

The logarithmic form of sound power. It is also expressed by attachment of the word decibel to the number. The logarithm is taken of the ratio of the actual sound power to a reference sound power, which is 1 pico-watt. Sound power level cannot be measured directly, but can only be deduced through measurements of sound intensity or sound pressure around the source. The equation for it is

$$L_w = 10\log_{10}\left[\frac{W}{W_0}\right] \quad W = W_0 10^{L_w/10}$$

Sound Speed

The speed at which sound waves propagate. It is measured in meters per second. It should not be confused with sound or particle velocity which relates to the physical motion of the medium itself.

$$c = 20.05\sqrt{\text{degC} + 273} \quad \text{m/sec}$$

$$c = 49.03\sqrt{\text{degF} + 460} \quad \text{ft/sec}$$

Spectrum (Frequency Spectrum)

The amplitude of sound or vibration at various frequencies. It is given by a set of numbers that describe the amplitude at each frequency or band of frequencies. It is often prefixed with a descriptor that identifies it such as sound pressure spectrum. It is generally expressed as a spectrum level.

Taktmaximal-5

An integration of the five second maximum A frequency weighted, fast time weighted sound pressure levels.

$$L_{AFM5} = 10 \cdot \log \left[\frac{\sum \left(10^{\frac{L_{AF \max 5s(n)}}{10}} \right)}{n} \right]$$

Where:

$L_{A \max 5s(n)}$ is the maximum A-weighted fast exponential time weighted sound pressure level for each n 5-second time period

and

n is the number of 5 second periods accumulated during the measurement.

Threshold Sound Level (Lt)

The A-weighted sound level below which the sound produces little or no Noise Dose accumulation and may be disregarded. It is used for hearing damage risk assessment.

Standard: ANSI S1.25

Time Weighted Average Sound Level (TWA, $L_{TWA(TC)}$)

It is the level of a constant sound over the Criterion Duration, that would expose a person to the same Noise Dose as the actual (unsteady) sound over the same period. If the Exchange Rate is 3 dB then the TWA is equal to the L_{eq} .

$$L_{TWA(TC)} = K \log_{10} \left(\frac{1}{T} \int_{T_1}^{T_2} 10^{(L_p(t))/K} dt \right)$$

where $T_c = T_2 - T_1$ and K is the Exchange Rate Factor. It is used for hearing damage risk assessment.

Standard: ANSI S12.19

Time Weighting

The response speed of the detector in a sound level meter. There are several speeds used.

Slow: The time constant is 1 second (1000 ms). This is the slowest and is commonly used in environmental noise measurements.

Fast: The time constant is 1/8 second (125 ms). This is a less commonly used weighting but will detect changes in sound level more rapidly.

Impulse: The time constant is 35ms for the rise and 1.5 seconds (1500 ms) for the decay. The reason for the double constant is to allow the very short signal to be captured and displayed.

Vibration

The oscillatory movement of a mechanical system (generally taken to be solid). It is used as a broad descriptor of oscillations.

Wavelength (λ)

The distance between peaks of a propagating wave with a well defined frequency. It is related to the frequency through the following equation

$$\lambda = \frac{c}{f}$$

where c is the sound speed and f is the frequency in Hz. It has the dimensions of length.

Wavenumber (k)

A number that is related to the wavelength of sound and is used to compare the size of objects relative to the wavelength or the time delay in sound propagation. It is related to wavelength through the following equation

$$k = \frac{2\pi}{\lambda} = \frac{2\pi f}{c} = \frac{\omega}{c}$$

where λ is the wavelength, c is the sound speed, f is the frequency in Hz, and ω is the radian frequency. It has the dimensions of inverse length.



Larson Davis - a PCB Piezotronics division

GMGA MEASURING

**Address: No. 33 Alley 99/120 Dinh Cong Ha, Dinh Cong Ward,
Hoang Mai District, 10000 Hanoi City, Vietnam**

Telephone: [+84 845 969 336](tel:+84845969336)

Email: info@gmga.vn

Website: <https://gmga.vn/>

