

NMS044

Outdoor Noise Monitoring System Reference Manual



Larson Davis

SoundAdvisor™

Model NMS044

Reference Manual

Copyright

Copyright 2022-2023, by PCB Piezotronics, Inc. This manual is copyrighted, with all rights reserved. The manual may not be copied in whole or in part for any use without prior written consent of PCB Piezotronics, Inc.

Trademarks in this Manual

Android and the Google Play Store are trademarks of Google, LLC in the U.S. and in other countries. iTunes Store is a trademark of Apple, Inc. in the U.S. and in other countries. IOS is a registered trademark of Cisco Systems in the U.S. and in other countries. SoundAdvisor 831C and SoundLink are trademarks of PCB Piezotronics, Inc.

Disclaimer

The following paragraph does not apply in any state or country where such statements are not agreeable with local law:

Even though PCB Piezotronics, Inc. has reviewed its documentation, PCB Piezotronics Inc. makes no warranty or representation, either expressed or implied, with respect to this instrument and documentation, its quality, performance, merchantability, or fitness for a particular purpose. This documentation is subject to change without notice, and should not be construed as a commitment or representation by PCB Piezotronics, Inc.

This publication may contain inaccuracies or typographical errors. PCB Piezotronics, Inc. will periodically update the material for inclusion in new editions. Changes and improvements to the information described in this manual may be made at any time.

Safety

If the equipment is used in a manner not specified by Larson Davis, the protection provided by the equipment may be impaired.

Recycling

PCB Piezotronics, Inc. is an environmentally friendly organization and encourages our customers to be environmentally conscious. When this product reaches its end of life, please recycle the product through a local recycling center or return the product to PCB at the following address:



PCB Piezotronics, Inc.
Attn: Recycling Coordinator
1681 West 820 North
Provo, Utah, USA 84601-1341

Warranty

For warranty information, refer to the [Larson Davis Product Warranty page](#).



Table of Contents

Module 1	System Overview -----	1
	1.1 System Contents	
	1.2 Optional Accessories	
	1.3 Understanding NMS044 Power Consumption	
Module 2	Getting Started -----	9
	2.1 Completing System Assembly	
	2.2 Establishing Service for the Gateway	
	2.3 Connecting the Gateway to Cellular Service	
	2.4 Reviewing 831C SLM System Properties for Use With NMS044	
	2.5 Using SoundLink™	
Module 3	Installing the NMS System -----	21
	3.1 Assembling Travel Packs	
	3.2 Assembling the EPS2116 and Preamplifier	
	3.3 Installing the Pole and EPS2116	
	3.4 Connecting the Solar Panel	
	3.5 Powering On the NMS044 System	
	3.6 Calibrating the Sound Level Meter	
	3.7 Conducting a Final Equipment Check	
Module 4	Making Measurements -----	30
	4.1 Configuring a Measurement Setup	
	4.2 Downloading and Viewing Measurement Data	
Appendix A	Additional System Information -----	A-1
	A.1 System LED Indications	
	A.2 Shipping and Storage Requirements	
	A.3 Understanding 831C SLM Connections	
	A.4 Updating NMS044 for Modem Low Power	
	A.5 Configuring the Gateway for Larson Davis Instruments	
Appendix B	Technical Specifications-----	B-1
	B.1 Physical Characteristics	

Module 1 System Overview

The SoundAdvisor Model NMS044 noise monitoring system is the practical solution to short- or long-term, unattended sound level monitoring. Power is supplied by a 12-Volt battery, charged by a solar panel, which is positioned in an area where sunlight is most available.

In this module:

- 1.1 System Contents 2
- 1.2 Optional Accessories 5
- 1.3 Understanding NMS044 Power Consumption 6

Figure 1-1 EPS044/NMS044 Features



1. Reliable and Durable The system (including the battery, charge controller, antennas, modem, and SLM) is enclosed in a durable case. The environmentally-protected, prepolarized microphone and preamplifier provide reliable acoustic measurements.

2. Portable, Easily Deployed System The system weighs as little as 50 lb (23 kg). This enables one person to deliver and set up the system in only a few minutes. The NMS044 can be deployed, before, during, or after you setup the 831C.

3. Remote Connectivity Access and control the system remotely by connecting to the gateway via a cellular network on your mobile phone or PC. Using LD Atlas (mobile) or G4 LD Utility (PC), view and download data anytime.

4. Low Power Consumption When enabled and used in conjunction with the low power cable, the modem low power mode runs basic features with exceptionally low power consumption. When a solar panel is part of the system, a minimal amount of sunlight is needed to reboot in case a power loss occurs. Using solar power, the system charges to capacity in only a few hours.

5. Continuous Sound Measurement When using Continuous Run Mode, if the battery is ever close to depleted, the system is designed to save the current measurement data and shut down safely. When the battery is sufficiently recharged, the system powers on and the previous measurement

continues.

1.1 System Contents

In this section, review your system contents to identify items received.

- **NMS Systems: Outdoor Equipment for Environmental Noise Monitoring**
- **EPS Kits: Outdoor Equipment for Environmental Noise Monitoring**

NMS Systems: Outdoor Equipment for Environmental Noise Monitoring

NMS systems are identified here in terms of the battery type and solar panel size. *Table 1.3* shows which NMS systems use EPS044-SLA kits or EPS044-LFP kits for power and lists system contents. See *Figure 1-2* for an image of each item.

Figure 1-2 Images of NMS044 Systems Contents



Table 1.3 Description of NMS044 Systems Contents

Contents	Kit#			
	NMS044-SLA100*	NMS044-LFP100*	NMS044-KIT1-U	NMS044RI-SLA100-U
<p>*Kit is available as: <i>kit</i> ^Y-U: EMEA modem, PSA039 with U.S. plug <i>kit</i> ^YE: EMEA modem, PSA039 with Int'l plug <i>kit</i> ^YA: APAC modem, PSA039 with Int'l plug</p>				
<p>1. SoundAdvisor 831C Sound Level Meter (831C) with Firmware Options 831C-ELA, 831C-LOG, 831C-SW</p>	X	X		X
<p>2. G4 LD Utility Software</p>	X	X		X

Table 1.3 (Continued) Description of NMS044 Systems Contents

Contents	Kit#			
	NMS044-SLA100*	NMS044-LFP100*	NMS044-KIT1-U	NMS044RI-SLA100-U
<p>*Kit is available as: kit Y-U: EMEA modem, PSA039 with U.S. plug kit YE: EMEA modem, PSA039 with Int'l plug kit YA: APAC modem, PSA039 with Int'l plug</p>				
3. RV50X cellular gateway with GPS antenna (COM-RV50X)	X	X		X
4. 100 W Solar Panel kit (SLP002)	X	X		X
5. Environmental Protection for Outdoor Acoustic Equipment Kit (EPS2116)	X	X		X
6a. Preamplifier/Mic Combo: PRM2103FF & 377B02	X	X		
6b. Preamplifier/Mic Combo: PRM2103FF & 377C20				X
<p>7. Cables & Adapters: Signal cable with LP Mode (CBL222LP) Gateway to power block cable (CBL223) Gateway to SLM power switch cable (CBL218) USB to micro-B cable for system setup (CBL138) 2-port USB Adapter (DVX015) 120 V AC Battery Charger Adapter (PSA039)</p>	X	X		X
EPS044-SLA Kit See <i>Figure 1-4</i> for kit contents.	X			X
EPS044-LFP Kit See <i>Figure 1-4</i> for kit contents.		X		

EPS Kits: Outdoor Equipment for Environmental Noise Monitoring

Table 1.5 lists the contents of 3 outdoor environmental kits. See Figure 1-4 for images of each item.

Figure 1-4 Images of EPS044-SLA, EPS044-LFP, and EPS044 Kit Contents

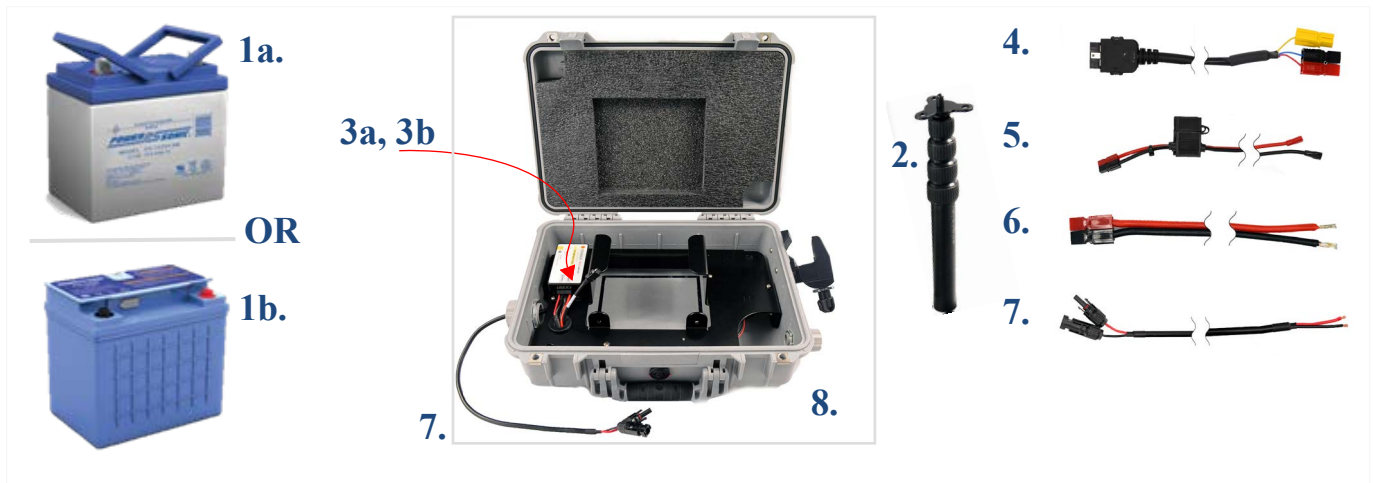

Table 1.5 Description of EPS044-SLA, EPS044-LFP, and EPS044 Kit Contents

Contents (See Figure 1-4)	EPS044-SLA	EPS044-LFP	EPS044
1a. 35 Ah 12 V SLA Battery (BAT020)	X		
1b. 45 Ah 12 V LiFePo Battery (BAT019)		X	
2. Telescoping pole (ACC010)	X	X	X
3a. Solar Charge Controller for SLA (PSA038)	X		X
3b. Solar Charge Controller for Lithium (PSA044)		X	
4. 831C to power block cable (CBL224)	X	X	X
5. Fused battery cable (CBL225-01)	X	X	X
6. Charge control to power block cable (CBL226)	X	X	X
7. Solar Panel to solar charger cable (CBL228)	X	X	X
8. Durable and protective case kit (CCS051) See Table 1.6 for kit contents.	X	X	X
Foam spacer for SLA battery	X		
Kit Accessories: canvas bag, guy wire ring, pole stabilization lines and stakes	X	X	X

Table 1.6 Description and Images of Durable and Protective Case Kit (CCS051)

Contents	
<ol style="list-style-type: none"> 1. Environmentally protective case 2. Metal case plate 3. Power distribution block (underneath case plate) 4. Super clamp for pole attachment 	
<p>Rubber Stoppers (2) one for CBL222-08 or CBL222-20, and one for EXC cable (application depends on the chosen preamplifier; see <i>Figure A-6</i> or <i>Figure A-7</i>)</p>	
<p>Kit Accessories: silicone grease for cable glands, hook and loop straps, cable ties, solar ring tool</p>	

1.2 Optional Accessories

Hardware

- 32 GB USB Flash Storage (831-MEM32G)
- Precision Acoustic Calibrator (CAL200)

Firmware

Sound Recording Firmware (831C-SR)

The optional Sound Recording firmware upgrade enables you to make event-based and manual sound recordings in WAV or OGG format. Recordings are stored in the measurement data and can be shared via email.

Scheduling Firmware (831C-SCH)

The optional Scheduling firmware upgrade (831C-SCH) enables you to conserve system power and data usage while conducting measurements based on a repeatable weekly schedule with schedule blocks for the following functions:

- Meter Run, Stop, Store
- Specific Measurement Trigger Levels
- Alert Notifications

- RV50X Modem Low Power

All features of the firmware option are accomplished by using G4 LD Utility software. For more information, contact your sales representative or see the *SoundAdvisor 831C Manual*, Module 6, which is available on the included Larson Davis USB drive or at www.LarsonDavis.com.

Software

LD Atlas App for Mobile



With an established cellular connection, you can use the LD Atlas app to communicate with the SoundAdvisor™ 831C SLM. LD Atlas is available for Android® from the Google Play Store®, or for IOS® from the iTunes Store®¹. To install the app: open the app store on your mobile device, search for “LD Atlas,” and follow the prompts.

1.3 Understanding NMS044 Power Consumption

We recommend the following three ideas to make the most of your available power. The first is a basic formula you can use to estimate your system’s daily power consumption. The second is to employ the modem low power feature as an effective means to decrease system power consumption. The third is to explore helpful resources to better understand the recommendations and requirements of using a solar panel to recharge battery power.

In this section:

- [Estimating Power Consumption](#)
- [Understanding the Modem Low Power Feature](#)
- [Making the Most of Your Sunlight Hours](#)

Estimating Power Consumption

To estimate how much power your system requires per 24 hours, use the formula shown in *Figure 1-7*.

Figure 1-7 Formula for Average Watt-hours Used Per Day

$$P_{24hr} = 24 (1.3 \text{ W} + \frac{t}{24} (2.05 \text{ Watts}))$$

t = time, in hours, that the modem is powered

1. See the inside front cover of this manual for trademark information.

To estimate the system run time in days, based on the available battery power, calculate the following:

Figure 1-8 Formula for Days of Available Battery Power in Watt-hours

$$\text{Estimated Run Time (days)} = \frac{\text{Battery (Wh)}}{(P_{24\text{hr}} \times 2)^*}$$

Battery Capacity (Wh):
BAT020: 35 Ah SLA Battery = 420 Wh
BAT019: 45 Ah LiFPo Battery = 540 Wh

*50% safety factor to account for effects of temperature and aging on the battery

Understanding the Modem Low Power Feature

Modem Low Power is an 831C system property that can be enabled or disabled to facilitate your use. When enabled, the gateway is powered down except for these periods:

- When the 831C SLM powers it on to send alert notifications
- When the SLM sends a file to the cloud (SFTP, Dropbox, etc.)
- During the scheduled awake period (via 831C-SCH optional firmware add-on)



An NMS044 system purchased later than July 1, 2020 comes ready to use modem low power, with the power cable (CBL222LP) and SLM firmware (version 4.5 or later). To prepare an NMS system purchased prior to July 1, 2020 for low power, see **“Updating NMS044 for Modem Low Power” on page A-7**.

When modem low power mode is used in conjunction with the 831C Scheduling option (add-on 831C-SCH), additional power savings and regulation are possible. This option allows you to schedule measurements as well as periods when the modem uses low power. For more information on the 831C Scheduling option, open G4 LD Utility, and navigate to **Help → Manuals → G4 LD Utility Manual → Module 6.3**.

Making the Most of Your Sunlight Hours

For best results, we encourage you to take advantage of the most daylight and direct sun for the area of deployment. The EU Science Hub’s Solar Radiation Tool, can provide an estimate of how your system performs in a particular location based on radiation data gathered for that location in the recent past.

Step 1. Visit the European Commission EU Science Hub’s **Photovoltaic GIS (PVGIS)** website.

- Step 2.** Select the Solar Radiation Tool, then select a location on the map.
- Step 3.** Choose the **Off-Grid** tab, enter the following parameters, then click **Visualize Results**.
- **Installed Peak PV Power** (“100 W,” depending on your solar panel)
 - **Battery Capacity** (BAT021, LiFePo battery = “540 Wh”; (BAT 019, SLA battery = “420 Wh”)
 - **Discharge cutoff limit** is “10%”
 - **Consumption per day** = “80 Wh” (typical), but convert the result of your calculation in *Figure 1-7* from watts to watt hours, and use this value.
 - Enter the **Slope** of the solar panel, and the **Azimuth**. To find the azimuth, do the following:
 - a. Open this link for the **NOAA ESRL Solar Position Calculator**.
 - b. Enter the **City** or the **coordinates** of the NMS system and click **Calculate Solar Position**.
 - c. The **Solar Azimuth** value - 180 = **Azimuth**. Enter this value in the Solar Radiation Tool.
- Step 4.** Select the  **Performance** view. The result should have no red bars (days with no battery power). Select the  **Battery State** view. A desirable result shows the battery is not fully discharged at any time.
- Step 5.** To adjust for better results, adjust the **Slope** of the solar panel, or adjust the system location and **Azimuth**.

Recommended next step:

- [Module 2 Getting Started](#)

Module **2** Getting Started

Your system ships from the factory tested and assembled, except for the final battery connections and final gateway configuration details. While these can be done in the field after installation, we recommend completing these sections prior to remote installation.

This module assumes that you have the complete NMS044 with all components. The setup is similar for the EPS044, and the following sections apply to that component as well.

In this module:

2.1	Completing System Assembly	10
2.2	Establishing Service for the Gateway	13
2.3	Connecting the Gateway to Cellular Service	15
2.4	Reviewing 831C SLM System Properties for Use With NMS044	19
2.5	Using SoundLink™	20

2.1 Completing System Assembly

Figure 2-1 System Wiring Overview is shown here as reference for all system connections.

Figure 2-1 System Wiring Overview

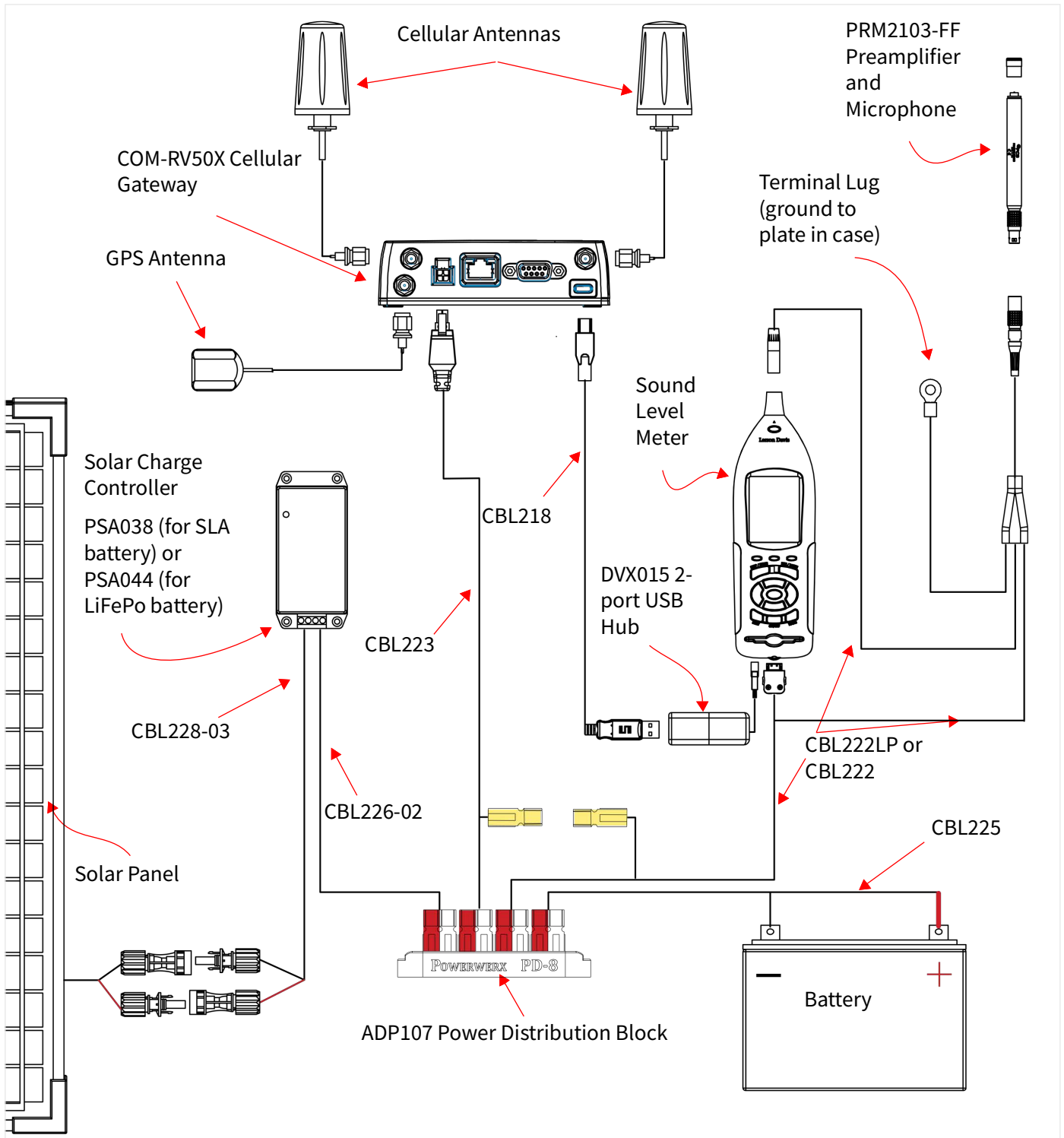

2.1.1 Preparing the System Battery

Your NMS system ships from the factory tested and assembled, except for the final connection to the external battery. This section shows how to charge and connect the external system power.

Step 1. Install the battery in the case and connect CBL225 as shown in *Figure 2-2*.

Figure 2-2 Battery Installation Sequence

a. Open the case and lift out the plate being careful not to pull any wires loose. Set the plate at an angle away from case.



b. If not already in place, set the battery inside the guide lines with the terminals toward the bottom of the case.

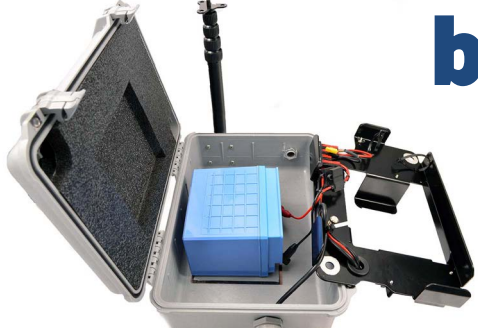

c. For the battery connection (CBL225), insert the connectors into the power distribution block—red to red and black to black—side by side in any available connector. See *Figure 2-1 System Wiring Overview* for reference.

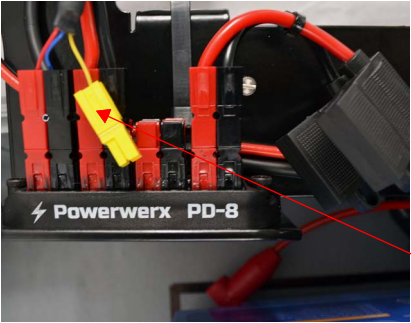

d. When using EPS044 package only, leave the yellow connector disconnected.

Step 2. (Optional) If you want to charge the system battery prior to deploying, do the following:

Charging the System Battery Using AC Power (NMS044 System Only)

- Connect the solar connectors (CBL228) to the AC battery charger (part of PSA039). The solar connectors extend from the solar charge controller; PSA039 is included with the NMS044 system. Refer to *Figure 2-1 System Wiring Overview* for details.
- Plug into an external AC power source (wall outlet).
- When the battery is fully charged, disconnect the AC battery charger from CBL228 as shown in *Figure 2-2*.

- When the LED on the solar charge controller is blinking green, the battery is charging.
- When the LED is solid green, the battery is nearly full or fully charged.
- When the LED is dark, ensure the battery is properly installed and the system is powered on. For more information, see **“LED Indicators for Solar Charge Controllers”** on page A-4.

Figure 2-3 Disconnecting the Solar Connectors (CBL228)

If you need to disconnect the solar connectors, a tool is provided. 1) Insert the tool in the middle of the connection 2) pinch the locking mechanism, then pull apart.



Step 3. (Optional) If your system included the Sealed Lead Acid battery (BAT020), insert the included foam spacer (1 x 8 x 5-inches; 2.5 x 20 x 13-cm) to fill the space between the battery and the 831C SLM.

Figure 2-4 Foam Spacer Placement for BAT020



Step 4. Place the mounting plate back into the case over the battery until fully seated.

2.2 Establishing Service for the Gateway

Establishing cell service for the gateway includes purchasing a SIM card with cellular service and installing it. As indicated in this section, you can also opt to have Larson Davis install and activate the SIM when your system is prepared at the factory.

2.2.1 Purchasing Cellular Service

Review this section prior to purchasing cell service.

The NMS044 system requires a SIM card with a data plan. SIM cards should be configured with a static IP address or alternatively with a dynamic IP address used in conjunction with the optional SoundLink service, as described in this section. Where available at an affordable price, we recommend using a SIM card configured with a static IP address.

Step 1. When shopping for a cellular provider, verify that the service supports a public, static IP address, and that incoming connection requests are not blocked.

If this type of SIM card and service is available, move to the next step; if not, we recommend the SoundLink online hosting service. This enables you to establish a secure connection to your gateway(s) using any IP address on a virtual private network (VPN). Contact Larson Davis or your representative for more information about this subscription-based service.

Step 2. Purchase a SIM card with the following features:

- A data plan sufficient to the NMS044 data usage

The amount of data your system requires is variable. For most applications, 4 GB per month is sufficient. While precautions have been taken to prevent high data use, the NMS system doesn't regulate data use. Significant charges may occur if the purchased data amount is exceeded.

- No messaging/voice is needed.

Step 3. If your SIM card is configured with a static IP, request the APN (Access Point Name) from your cellular provider. You will need it later in the process to configure your system for remote use.

TAKE NOTE If you would like Larson Davis to install the SIM and configure remote communication along with your equipment order, mail your SIM card, contact information, and APN (if applicable) to the following address:

NMS System Configuration
Larson Davis Manufacturing Center
1681 West 820 North
Provo, Utah 84601 USA

Recommended next step:

- If Larson Davis is installing the SIM card, move to **2.3 "Connecting the Gateway to Cellular Service" on page 15**. If Larson Davis is not installing the SIM card, move to **2.2.2 Installing the SIM Card**.

2.2.2 Installing the SIM Card

With the system powered off, install the SIM card by following these steps:

Step 1. Using the provided #2 Phillips head screw driver, remove the 2 screws holding the gateway to the case plate, as shown in *Figure 2-5*.

Step 2. Make note of the unique password on the label on the bottom of the RV50X

Figure 2-5 Removing the Gateway From the Case Plate

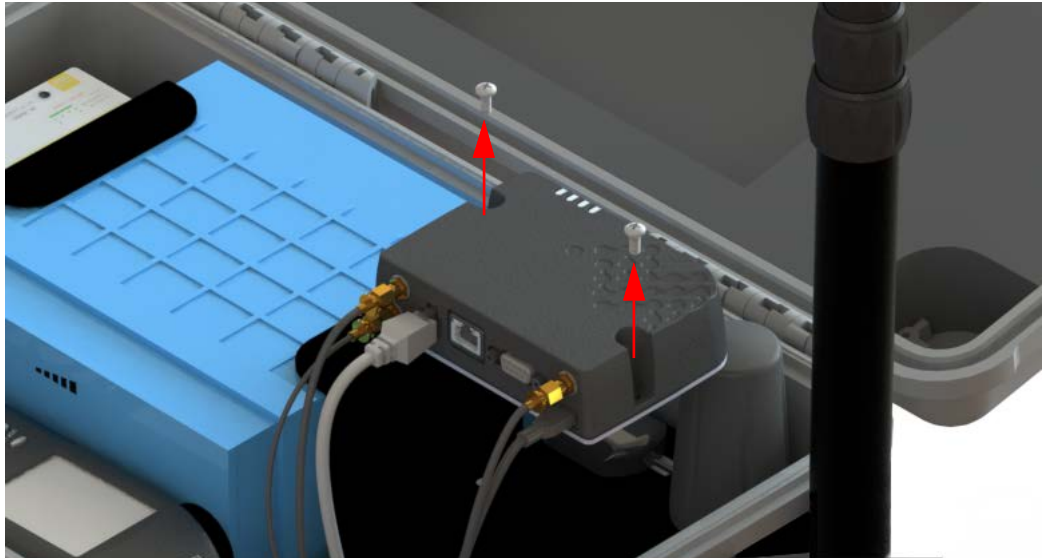

Step 3. Using the #0 screwdriver, remove the 2 screws holding the front SIM card door, shown in *Figure 2-6*.

Figure 2-6 RV50X Sim Card Door Removed



Step 4. Insert the SIM card into to the top slot until it clicks.

Step 5. Replace the SIM card door and screws.

Step 6. Remount the RV50X in the case and hand-tighten the 2 case plate screws.

2.3 Connecting the Gateway to Cellular Service

This section shows you how to use your PC to connect the gateway to your cellular service, and verify that the service is working. The final configuration details must be provided by you. This section guides you through this process.

In this section:

- **2.3.1 Connecting the Gateway via USB**
Part 1: Connecting and Logging In
Part 2: Entering Cellular Network Credentials
- **2.3.2 Verifying Remote Communications via a Mobile Device**

2.3.1 Connecting the Gateway via USB

Before you begin:

- If you purchased the gateway from someone other than Larson Davis, or it has been reset to factory settings, complete the process shown in **“Configuring the Gateway for Larson Davis Instruments” on page A-10.**
- Prepare cellular service as shown in **2.2 Establishing Service for the Gateway.**

Part 1: Connecting and Logging In

Step 1. Connect the RV50X gateway to your PC as shown in *Figure 2-7.*

Figure 2-7 Connecting to RV50X

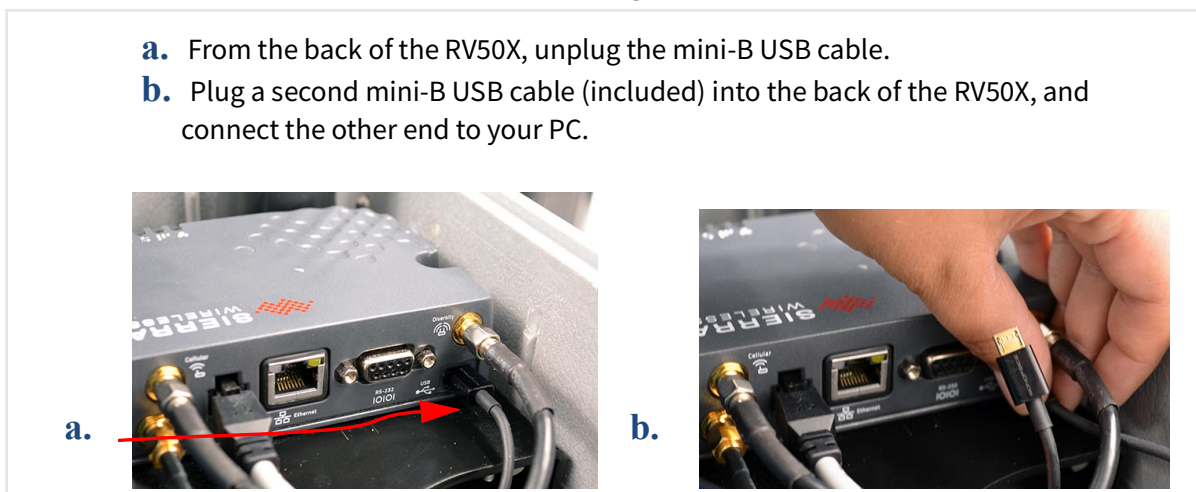

Step 2. If the system is not already on, power on the system by pressing the power button on the 831C.

TAKE NOTE The modem may take several minutes to boot. Check the status LEDs for progress. When the third LED from the left is solid green or amber, the gateway is connected to a network.

LEARN MORE For additional information, see **“Gateway LED Indications” on page A-3.**

Step 3. Open a web browser on the connected PC, and enter “<http://192.168.14.31:9191>” into the address bar. This opens ACEmanager, the gateway configuration console.

Step 4. If this is your first time logging in, log in as “user” with the password “LD_NMSystem16.”

Figure 2-8 User Login

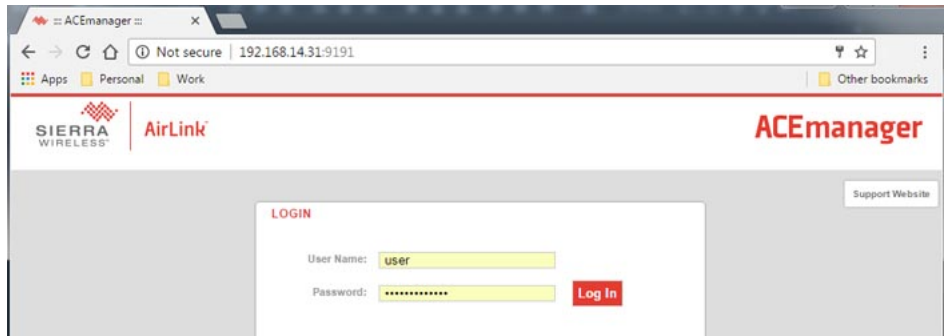

TAKE NOTE If the login is not working, it’s possible that the gateway has not been configured for use with Larson Davis instruments. If this is the case, refer to section “[Configuring the Gateway for Larson Davis Instruments](#)” on [page A-10](#).

Step 5. Change the password as shown in steps 5a–5e.

Changing Your Password

- a. Navigate to the **Admin** menu, as shown in *Figure 2-9*.
- b. If this is your first time logging in, enter “user” with the password “LD_NMSystem16”. Otherwise, log in with the user name and password previously set for this system.

TAKE NOTE If you need to reset the gateway to factory settings at some future time. Examine the label on the bottom of the modem for the factory password.

Figure 2-9 Admin Tab

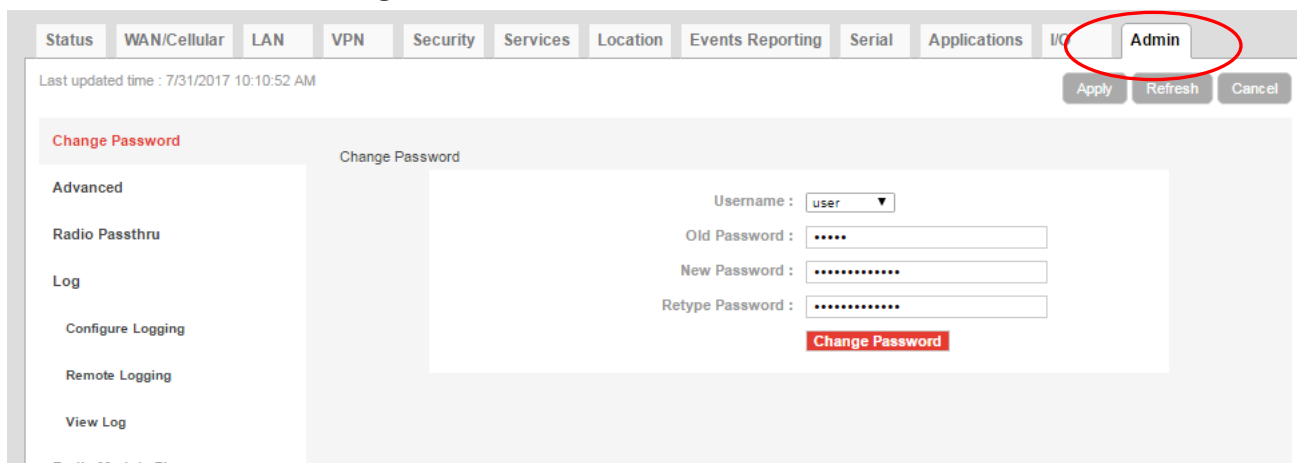

- c. On the Change Password sidetab, enter a unique password in **New Password**, and again in **Retype Password**.
- d. Record your password. If you forget it you will need to reset the gateway to factory settings and reconfigure.
- e. Click **Change Password**, then click **Apply** in the top right.

Part 2: Entering Cellular Network Credentials

- Step 1.** Select the **WAN/Cellular** menu, then choose the **Cellular** → **SIM Slot 1 Configuration** sidetab as shown in *Figure 2-10*.

Figure 2-10 WAN/Cellular tab

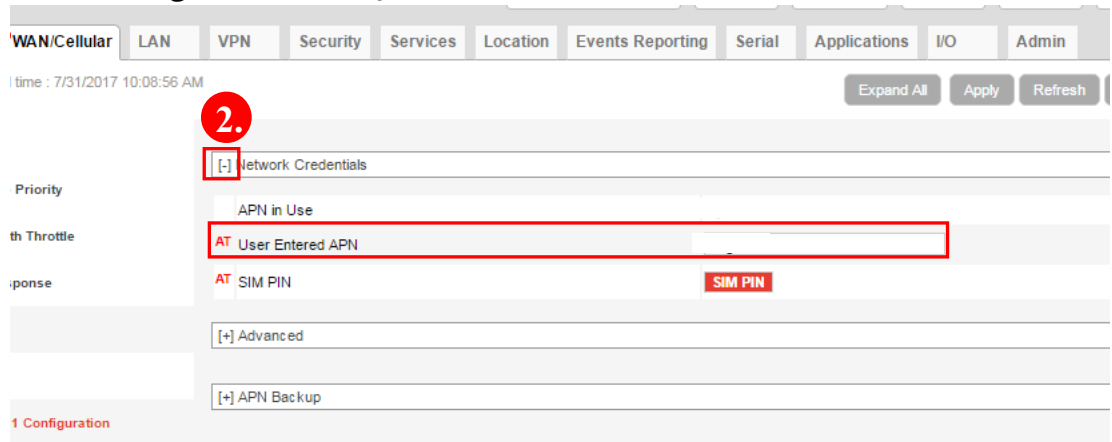

- Step 2.** Expand the **Network Credentials** menu, and enter the APN provided by your cellular provider in the **User Entered APN** field.
- Step 3.** Click **Apply** in the top right, then reboot the gateway. It may take up to 1 minute to reboot.
- Step 4.** Log in using the new password.
- Step 5.** Navigate to **Status** → **Home**. If the SIM card is set up correctly, the **Network State** field displays “**Network Ready**”.
- Step 6.** If your system relies on a static IP address, verify that the **Active WAN IP Address** matches the static address given to you by your cellular provider, as shown in *Figure 2-11*. If you’re using SoundLink IP Hosting service, the **Active WAN IP Address** should match your SoundLink IP address.

Figure 2-11 Status tab

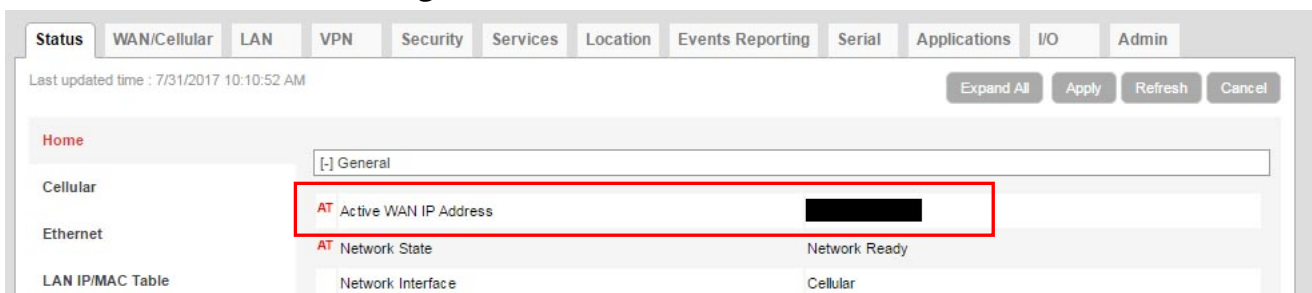

- Step 7.** Set up a Trusted IP (Friends) list to promote system security. When this is enabled, the IP addresses on this list can connect to the gateway. This prevents IP addresses not on the list from accessing your system and reduces power consumption resulting from unauthorized users repeatedly attempting to connect.

Setting Up the Trusted IP List

- Select the **Security** menu, then choose the **Trusted IP - Inbound (Friends)** sidetab.
- Under **Inbound Trusted IP List (Inbound Trusted IP Range)** enter the public IP address given to you by your cellular provider. Enter any other IP address (or

address ranges) that should have remote access to the gateway. Contact your local IT professional if you need more information.

- c. Set **Inbound Trusted IP (Friends List) Mode** to **Enable**.

Step 8. Click **Apply**, and **Log out** of ACEmanager.

Step 9. Disconnect the USB cable from the PC and modem. Return the original mini-B USB connector to the modem.

Step 10. Press the 831C **on/off** button to reboot the system.

2.3.2 Verifying Remote Communications via a Mobile Device

Establishing a connection to the SoundAdvisor™ 831C SLM prior to deployment verifies that the service is working properly. Larson Davis provides 2 useful utilities for conducting remote measurements:

- The **G4 LD Utility** software provides remote operation and control during measurements, with display, manipulation, and reports for the resulting measurement data.
- The **LD Atlas app** provides the same features for a mobile device.

This section demonstrates establishing a remote connection using a mobile device. You can also establish this same connection to the 831C SLM using G4 LD Utility on your PC.

Step 1. Download the **LD Atlas** app from the Google Play Store™ (for Android®) or from the iTunes Store™ (for iOS®)¹.



Step 2. Open the app, and tap the **plus icon** in-line with **Meters** in the top left. This opens the **Add New TCP/IP Meter** screen.

Step 3. Enter a **Name** for the NMS system.

Step 4. Enter the **IP Address/Host Name** from your cellular provider. If you are using the SoundLink IP Hosting service, enter the SoundLink IP address from your SoundLink Plan Details email.

Step 5. Leave the **Password** and **Port** fields blank unless instructed otherwise by your IT professional.

1. Trademark and registered trademark information is located on the inside front cover of this manual.

Figure 2-12 Meter Connected

Step 6. Tap the **blue plus button** to connect. The Add Meter screen closes. If the NMS system and your mobile device have cellular service, the serial number of the 831C displays in the Meters list with a blue meter icon. The meter is connected on your device.

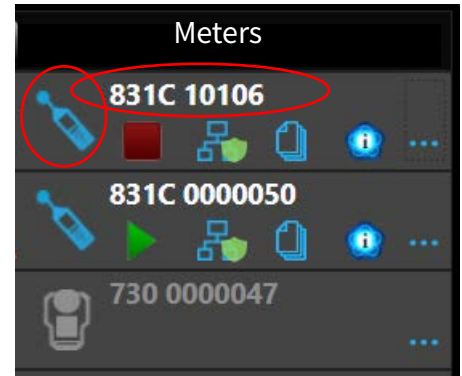

TAKE NOTE The connection may take up to 1 minute to display.

Step 7. Tap on the meter serial number to open the meter screen. From here, you can operate the 831C from the app.

2.4 Reviewing 831C SLM System Properties for Use With NMS044

If Larson Davis prepared your NMS044, the following 831C system properties, appropriate for use with the NMS044, are pre-selected for you.

If you are configuring your own system, we recommend these system properties.

- On the **System Properties** → **Power** page, choose **Alkaline** from the **Internal Battery** drop-down menu, and choose **Off** from the **Charge** drop-down menu.
- Set **Auto-Off Time** to **Never**.
- On the **System Properties** → **Preferences** page, **Auto-Store** is set to **Store**. This allows measurement data to be automatically saved at the end of each measurement.
- **GPS Mode** is set to **On**.

Recommended next step:

- If you're using SoundLink service, see **2.5 Using SoundLink™**. Otherwise, move to **Module 3 Installing the NMS System**.

2.5 Using SoundLink™

SoundLink¹ is an IP hosting service that provides secure communication with your remote noise monitoring systems using a dynamic IP address. This service from Larson Davis simplifies remote communication with your NMS system. It is an alternative to using a public, static IP address from your cellular provider, or a viable solution if one is not available. It works because G4 recognizes SoundLink as a static IP address even though the cell service connects via a dynamic IP address.

LEARN MORE For more information, contact your Larson Davis representative or view the SoundLink manual at LarsonDavis.com.

Larson Davis provides complete gateway configuration plus SoundLink configuration service for new or previously deployed gateways. For previously deployed units without a public, static IP, the SoundLink configuration service requires that you ship the gateway to Larson Davis.

For new systems, if you prefer to configure the gateway for SoundLink service yourself, complete the following steps:

- Step 1.** Complete the initial gateway setup as shown section **2.3 Connecting the Gateway to Cellular Service**.
- Step 2.** Complete the SLM setup as shown in section **2.4 Reviewing 831C SLM System Properties for Use With NMS044**.
- Step 3.** Complete SoundLink setup as shown in the SoundLink manual. The manual is attached to your SoundLink Plan Details email from Larson Davis. When this process is complete, your new NMS system is ready for deployment.

Recommended next step:

- **Module 3 Installing the NMS System**

1. For trademark details, see **"Trademarks in this Manual" on page 2**

Module 3 Installing the NMS System

This module demonstrates setting up the NMS044 in the field. We recommend that you review this module prior to delivering the system on site.

LEARN MORE If you want to access this information in video format, right-click [**NMS044 Assembly and Deployment video**](#) and open the video in a new browser tab.

In this module:

3.1	Assembling Travel Packs	22
3.2	Assembling the EPS2116 and Preamplifier	22
3.3	Installing the Pole and EPS2116	24
3.4	Connecting the Solar Panel	25
3.5	Powering On the NMS044 System	25
3.6	Calibrating the Sound Level Meter	26
3.7	Conducting a Final Equipment Check	27

Figure 3-1 Fully-deployed NMS044 system



3.1 Assembling Travel Packs

Assemble all components in the recommended 3 travel packs. See *Figure 3-2*.

Figure 3-2 NMS044 Deployment Travel Packs



3.2 Assembling the EPS2116 and Preamplifier

- Step 1.** Remove rubber cap from top of preamplifier.
- Step 2.** Place microphone on preamplifier, then gently screw together until hand tight. Set aside. (You can store these connected, so you don't need to repeat this step for each deployment.)

Figure 3-3 Connecting Microphone and Preamplifier

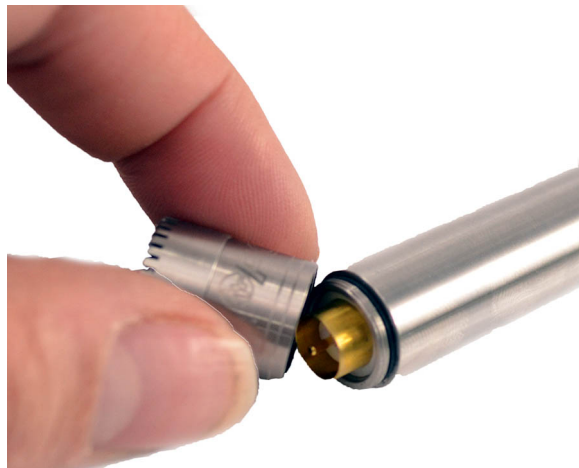

Step 3. Hold the EPS2116 windscreen and birdspike together, and unscrew the top section from the bottom section.

Step 4. Reassemble the top and base together. The EPS2116 should now appear in two pieces, as shown in *Figure 3-4*.

Figure 3-4 EPS2116 Separated



Step 5. Complete the steps shown in *Figure 3-5*.

Figure 3-5 EPS2116 Threading

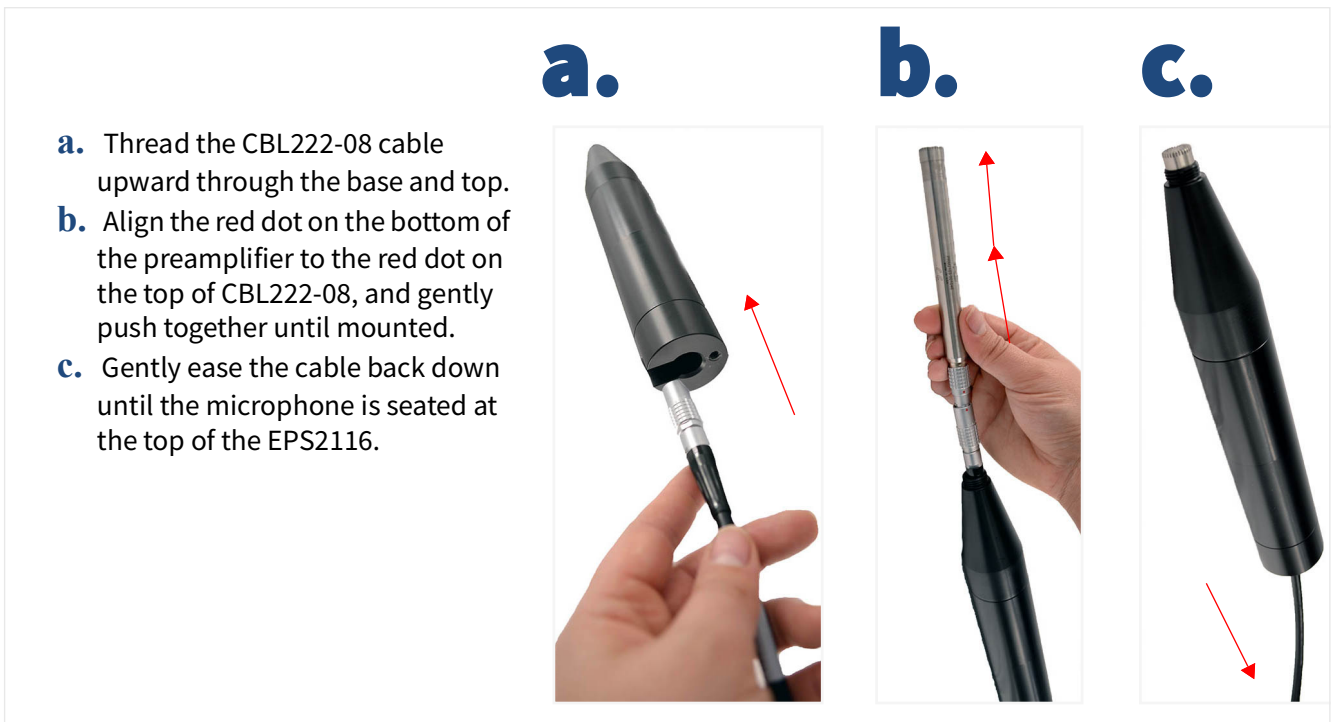

Step 6. Replace the birdspike and windscreen on top of the EPS2116.

CAUTION If you need to remove the windscreen, do not pull it off the birdspike with an upward motion. First, unscrew the birdspike by twisting its top and then pull the windscreen down over the bottom of the unscrewed birdspike.

LEARN MORE To learn more about the assembly of the EPS2116 refer to the *EPS2116 Reference Manual*.

3.3 Installing the Pole and EPS2116

- Step 1.** Remove the protective caps from the top and bottom of the telescoping pole.
- Step 2.** Put the guy wire ring on the top of the pole, and position the signal cable between two mount points on the guy wire ring.
- Step 3.** Place the EPS2116 on the top of the pole; and hold it still, while twisting the pole to screw the two pieces together as shown in *Figure 3-6*.

Figure 3-6 EPS2116 to Telescoping Pole



- Step 4.** Adjust the pole clamp screw, so the clamp is open to a 90° angle, as shown in *Figure 3-7*.

Figure 3-7 Pole Clamp is Ready to Receive the Pole



- Step 5.** Place the pole in the clamp on the system case, and twist clamp screw clockwise to secure the pole.

Figure 3-8 Telescoping Pole With Super Clamp



- Step 6.** To extend sections of the pole, loosen the telescoping pole binders, extend the pole, and tighten the binders.
- Step 7.** Use the hook and loop cable straps (already on the cable) to secure the signal cable to the pole.
- Step 8.** Place the guy wire ring over the screw, which is on the top of the pole.
- Step 9.** Steady the pole by tying the 3 guy wires to the guy wire ring on one end and the ground stakes on the other.
- Step 10.** Press the stakes into the ground, so that the guy wires are taught.

3.4 Connecting the Solar Panel

- Step 1.** Unlatch the solar panel to open.
- Step 2.** Loosen the thumb screws to extend legs. Match the angle of the legs on both sides.
- Step 3.** Connect the CBL228 solar connectors to the solar panel connectors.
- Step 4.** Place the solar panel in a secure, unobstructed, flat location facing toward the sky with optimal sunlight.

Figure 3-9 Solar Connection

We recommend placing stakes or a heavy weight, like sandbags, on the solar panel legs to keep it in place. For details on disconnecting solar connectors, see *Figure 2-3 on page 12*.



3.5 Powering On the NMS044 System

- Step 1.** Press the power button on the 831C to power the whole system on.

Figure 3-10 NMS044 Power



3.6 Calibrating the Sound Level Meter

Refer to your calibrator and microphone-preamplifier product manuals for specific requirements in performing the acoustic calibration.

TAKE NOTE For best results, use Larson Davis Precision Acoustic Calibrators and Larson Davis Microphone-Preamplifiers.

TAKE NOTE We recommended that you calibrate the 831C after deploying the system.

- Step 1.** Holding the windscreen and birdspike together, unscrew the assemblies until they come apart.
- Step 2.** Place the calibrator gently over the microphone to avoid sudden large pressure changes to the diaphragm.
- Step 3.** On the sound level meter, navigate to **Tools 3** → **Calibrate**.
- Step 4.** Select the calibrator from the **Select Calibrator** drop-down menu.
- Step 5.** If the calibrator settings need to be modified, click **Edit Settings**, make any necessary changes, then verify that the settings correspond to those described in the calibrator's manual.
- Step 6.** Press the power button on the calibrator.

Step 7. On the meter, select **Do Calibration**.

Figure 3-11 Acoustic Calibration



Step 8. After a few seconds, a message appears indicating the measured difference and a prompt to save the results. Click **Yes** to save the calibration, or click **No** to reject it.

Figure 3-12 Measured Calibration Difference

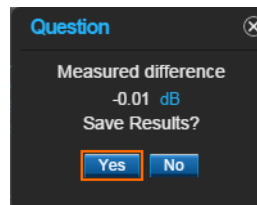

Step 9. Carefully remove the calibrator from the microphone.

Step 10. Select the Calibration History tab to view the acoustic calibration or the calibration check summaries.

Step 11. When the calibration process is complete, assemble windscreen and birdspike back on the microphone.

3.7 Conducting a Final Equipment Check

We recommend that you complete these steps prior to leaving the system.

3.7.1 Checking System Status Indicators

Figure 3-13 explains the system status indicators.

Figure 3-13 NMS System Status Indicators

1. Verify that the system battery is charged or charging.

The system battery is fully charged when the solar charge controller LED is solid green. A blinking green indicates it is currently charging.

LEARN MORE All system battery status indications are shown in [Table A.5 Genasun Solar Charge Controller LED Indication Patterns](#).

2. Check the gateway status.

The RV50X gateway has 4 LED status indicators on the side of the unit. From left to right, indicators inform you of the gateway's **Network**, **Signal**, **Activity**, and **Power**.



Figure 3-14 Gateway Status Indicators



All gateway status indicators are shown in [“LED Indicators for RV50X Cellular Gateway”](#) on page A-3.

3.7.2 Verifying Cellular Service by Using the LD Atlas App

Connecting to the 831C while in the field using the LD Atlas app helps you determine if the service is working properly. You can find a process for doing this in [2.3.2 "Verifying Remote Communications via a Mobile Device"](#) on page 18.

3.7.3 Acquiring the Gateway GPS Signal

When you deploy and power on the system, you can use LD Atlas or the G4 Live View, GPS Page to verify the gateway is streaming the GPS location. When configured correctly and when the gateway is positioned in the path of at least 3 satellite signals, the unit's GPS location displays on the GPS Page; 4 or more satellite signals activate the local time as shown in [Figure 3-15](#).

Figure 3-15 GPS Page, G4 Live View

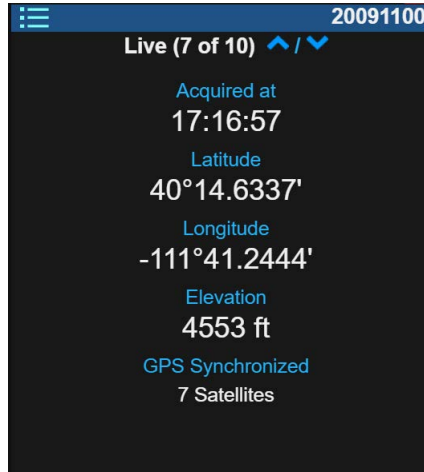

Troubleshooting the GPS Signal

Active GPS display is dependent on these settings:

- **831C GPS Mode:** Available on the 831C → Tools → System Properties → Other. For more information, see **2.4 "Reviewing 831C SLM System Properties for Use With NMS044" on page 19**
- **Gateway Location/Streaming Settings:** For details, see *Figure A-17* and *Figure A-18* in Appendix A.

3.7.4 Securing the Case With a Lock

The NMS044 case latches tight, and a lock can be used to secure it. You could also chain the system to a fixed object to deter theft.

Recommended next step:

- **Module 4 Making Measurements**

Module **4** Making Measurements

Configuring a measurement setup file for the SoundAdvisor™ 831C sound level meter can be done prior, during, or after deployment. You can change settings, check the measurement, or download data at any time.

In addition to this manual, the *G4 LD Utility Manual* and the *SoundAdvisor 831C Manual* contain a great deal of information about making measurements using Larson Davis instruments. This module refers you to each of these manuals as needed.

Before you begin:

- Assemble and activate your NMS system as shown in **Module 2 Getting Started** and **Module 3 Installing the NMS System**.

In this module:

4.1	Configuring a Measurement Setup	30
4.1.1	Reviewing and Saving a New Setup File	
4.1.2	Configuring the Meter to Send Alert Notifications	
4.1.3	Additional 831C Features and Settings	
4.2	Downloading and Viewing Measurement Data	34
4.2.1	Listening to Audio Files	

4.1 Configuring a Measurement Setup

For convenience, a default setup file for the NMS044 is included on the 831C. The file is named after the system. It contains metrics that are commonly used when measuring outdoor noise, such as:

- Measurement History with 1-hour measurement intervals
- Time History with 1-second updates to view noise as a function of time.
- Daily results
- Event Triggers, configured to send email alert notifications (when email is set up on the 831C).

Additionally, you may want to customize the SLM meter settings for your measurement. Complete the following processes to review and customize the SLM settings for your measurement.

In this section:

- **4.1.1 Reviewing and Saving a New Setup File**
- **4.1.2 Configuring the Meter to Send Alert Notifications**

- **4.1.3 Additional 831C Features and Settings**

4.1.1 Reviewing and Saving a New Setup File

If you need to customize the provided NMS044 setup file, be sure to save it with a custom name so you can reuse it another time or transfer it to a PC to be transferred to other meters.

Step 1. Using G4, navigate to the **Setup Manager**.

Step 2. On the right side (meter side), select the setup file **NMS044**.

Step 3. Click the **tab arrow**  in the bottom right or left to access and review pages of the Setup file as shown in *Figure 4-1*, *Figure 4-2*, *Figure 4-4*:

Figure 4-1 NMS044 Setup File: Control Page

- 1. Continuous Run Mode** is often used for outdoor noise measurements. In this mode the meter begins measuring when the meter is powered on and continues to run until you stop it, or until the meter is powered off. If the system loses power and then is recharged sufficiently, it powers on and automatically resumes measuring.
- The **Daily Auto Store** feature is set to store a data file once every 24 hours. As a result, the data file will contain 24 measurement intervals, with each one containing 1 hour of data.
- The PRM2103 preamplifier is set to do a daily automatic calibration check (**Cal. Check**) at 02:30:00 to ensure that the measurements are accurate.
- Measurement History** is only available with the 831C-ELA or 831C-MSR firmware option purchased and installed on the 831C SLM. For more information, contact Larson Davis as shown on the back cover of this manual.

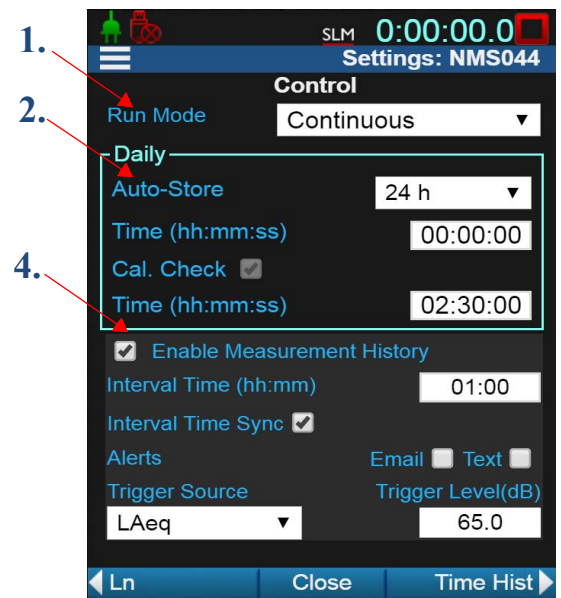

In addition to the meter run modes shown on the Control page, the 831C SLM offers a Scheduling firmware upgrade (831C-SCH) for use with G4 LD Utility. This upgrade enables you to operate a meter based on a repeatable weekly schedule with schedule blocks for the following meter functions:

- Meter Run, Stop, Store
- Specific Measurement Trigger Levels
- Alert Notifications
- Gateway (Modem) Low Power

LEARN MORE For more information about using this feature, in G4 go to **Help** → **Manuals** → **G4 LD Utility** → **6.3 Using Scheduling Firmware**.

Figure 4-2 NMS044 Setup File: Time History Tab

1. Using Time History with a 1-second **Period** creates one record each second in the measurement data table.

2. Each record contains the metrics selected in the Time History Options section. The NMS044 setup file currently contains the default metrics shown here.

Time History	A	C	Z
L _w eq	<input checked="" type="checkbox"/>	<input checked="" type="checkbox"/>	<input type="checkbox"/>
L _w peak	<input type="checkbox"/>	<input checked="" type="checkbox"/>	<input checked="" type="checkbox"/>
L _w S _{max}	<input type="checkbox"/>	<input type="checkbox"/>	<input type="checkbox"/>
L _w F _{max}	<input type="checkbox"/>	<input type="checkbox"/>	<input type="checkbox"/>
L _w J _{max}	<input type="checkbox"/>	<input type="checkbox"/>	<input type="checkbox"/>
L _w S _{min}	<input type="checkbox"/>	<input type="checkbox"/>	<input type="checkbox"/>
L _w F _{min}	<input type="checkbox"/>	<input type="checkbox"/>	<input type="checkbox"/>

The following settings, as shown on the Event Triggers, Event History, and Sound pages, create event-based sound recordings that are stored in the measurement data and can be shared via email.

Figure 4-3 NMS044 Settings: Triggers, Events, and Sound

1. The Event Trigger Method is set to **Level**.

2. When the measured sound level exceeds the set Trigger Level, an event is triggered and a sound recording begins. By default, the **Trigger Sources** are set to **SPL 1** and **Peak 1**. The **Trigger Levels** for these 2 sources can only be edited from the Exceedance Triggers page (press left arrow icon twice). Alternatively, you may select other **Triggers Sources** from the drop-down menu, and edit the associated Trigger Levels directly from the Event Triggers page.

3. The recording saves 7 seconds of sound as indicated in the **Snapshot Time** field. With the checkbox in-line with **Compression** selected, the sound file is saved using OGG compression. When this is the case, any email alert notifications sent as a result of the exceedance include the sound recording as an attachment.

LEARN MORE For more information about level and dynamic triggering, see *SoundAdvisor 831C Manual* → 17.5 Understanding Level and Dynamic Triggering.

For more information on configuring alert notifications, see *G4 LD Utility Manual* → 6.1.5 Understanding Alert Notifications

Step 4. When you're finished reviewing or editing the NMS044 Setup file, click the **menu icon** , and choose **Setup Manager**.

Step 5. If you made changes to the NMS044 setup file, do the following:

Saving a New Setup File

- a. Right-click on the name of the setup in the list. This opens the Menu.
- b. Choose **Save As**, enter a custom setup name, and click OK.

Figure 4-4 Setup Menu

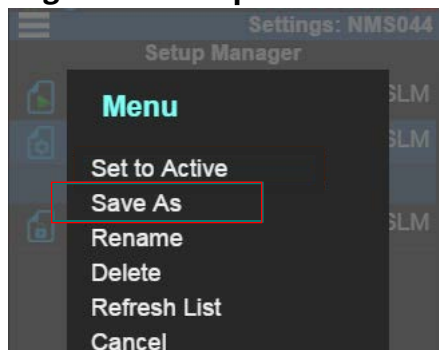

Step 6. Finally, in the Setup Manager list, highlight the setup you want to use for the upcoming measurement, right-click to open the Menu, and select **Set to Active**.

4.1.2 Configuring the Meter to Send Alert Notifications

The 831C SLM can be set up to send email and text alert notifications for a variety of system events, as well as measurement and sound events. When an event (setting change, exceedance trigger, sound event, etc.) occurs and the meter has an active network connection, the meter sends the alert notification after the event has concluded.

Using G4 version 4.5 or newer, alert notifications for system-, event-, and measurement history-triggered events are set up through a user account on the meter. To configure this, launch G4, and go to **Help** → **Manuals** → **G4 LD Utility Manual** → **Module 6.1 Getting Started With 831C Accounts in G4**. Additionally, you can apply the same process shown there (with slight adaptation for mobile) when using the LD Atlas app.

4.1.3 Additional 831C Features and Settings

The SoundAdvisor 831C provides additional settings and features that may be helpful for your measurement, including the optional Scheduling firmware add-on for 831C (831C-SCH).

For more information on using these features, in G4 go to **Help** → **Manuals** → **G4LD Utility Manual** → **Module 6 G4 Features for SoundAdvisor 831C**.

4.2 Downloading and Viewing Measurement Data

For more information about downloading and viewing measurement data, review the following modules. In G4 go to **Help** → **Manuals** → **G4 LD Utility Manual**:

- 2.5 Downloading Measurement Data Files
- 2.6 Viewing Downloaded Data in G4
- 2.7 Exporting Data to a Spreadsheet

4.2.1 Listening to Audio Files

For more information about listening to your recorded audio files, refer to the following modules. In G4, go to **Help** → **Manuals** → **G4 LD Utility Manual**:

- 3.3.2 Audio Playback for SLMs
- 3.3.3 Listening to Streaming Audio for SLMs

Appendix **A** Additional System Information

In this module:

A.1	System LED Indications	A-1
A.1.1	LED Indicators for SoundAdvisor™ Model 831C SLM	
A.1.2	LED Indicators for RV50X Cellular Gateway	
A.1.3	LED Indicators for Solar Charge Controllers	
A.2	Shipping and Storage Requirements	A-5
A.2.1	Shipping the System	
A.2.2	Preparing the System for Long Term Storage	
A.2.3	Removing Cables From the Case	
A.3	Understanding 831C SLM Connections	A-6
A.4	Updating NMS044 for Modem Low Power	A-7
A.4.1	Installing the Modem LP Cable	
A.4.2	Upgrading 831C SLM Firmware	
A.4.3	Enabling Modem Low Power	
A.5	Configuring the Gateway for Larson Davis Instruments	A-10
A.5.1	Logging In to ACEmanager	
A.5.2	Configuring LD Settings Utilizing the Template File	
A.5.3	Configuring LD Settings Without the Template File	

A.1 System LED Indications

This section is a reference for LED indicators on the 831C, the cellular gateway, and the solar charge controller.

In this section:

- **[A.1.1 LED Indicators for SoundAdvisor™ Model 831C SLM](#)**
- **[A.1.2 LED Indicators for RV50X Cellular Gateway](#)**
- **[A.1.3 LED Indicators for Solar Charge Controllers](#)**



A.1.1 LED Indicators for SoundAdvisor™ Model 831C SLM

The SoundAdvisor™ 831C has a multi-color back-lighted keypad, which provides the following colored indications for power and measurement statuses.

System Power Indicators

The system power status is indicated by the green LED behind the SLM **power button 0**.









Table A.1 Power Status LED Indicator Explained

Power Status	 Green LED
System is powering up or shutting down	 (fast, short green blink)

Measurement Status Indicators

SLM measurement status is indicated by the LEDs behind the **Stop button 7** and the **Play/Pause button 9** as shown in *Table A.2*.

Table A.2 Measurement Status LED Indicators Explained

Measurement Status	 Red LED 7	 Green LED 9
Stopped with Reset	 (long, quick red blink)	off
Stopped	 (Long then short red blink)	off
Paused	 (short red blink)	 (short green blink)
Running	off	 (Long then short green blink)
Waiting for valid data to begin running	 (short delayed blink)	off

A.1.2 LED Indicators for RV50X Cellular Gateway

When installed and running, the state of the gateway is indicated by the 4 LEDs on the side and bottom of the device. Individual lighted LEDs and combination lighted LED indications are listed in *Table A.3*:

Table A.3 Gateway LED Indications

LED	Color/Pattern	Description
Power	Off	No power or input voltage > 36 Vdc or < 7 Vdc
	Solid Green	Power is present
	Green with Amber Flash	Power is present and the gateway has a GPS fix
	Solid Red	Standby mode
	Flashing Green	When you press the reset button, flashing green indicates when to release the reset button to reboot the gateway.
	Flashing Red	When you press the reset button, flashing red indicates when to release the reset button to reset the gateway to the factory default settings.
Signal	Solid Green	Good signal (equivalent to 4-5 bars)
	Solid Amber	Fair signal (equivalent to 2-3 bars)
	Flashing Amber	Poor signal (equivalent to 1 bar) If possible, move the gateway to a location with a better signal.
	Flashing Red	Inadequate (equivalent to 0 bars) If possible, move the gateway to a location with a better signal
Network	Solid Green	Connected to an LTE network
	Solid Amber	Connected to a 3G or 2G network
	Flashing Green	Connecting to a network
	Flashing Red	No network available
	Flashing Red/Amber	Network Operator Switching is enabled, but the gateway is unable to locate the required firmware. For more information, contact Sierra Wireless®.
Activity	Flashing Green	Traffic is being transmitted or received over the WAN interface.
	Flashing Red	Traffic is being transmitted or received over the serial port. This behavior only appears if the RV50X is configured to display it. For more information, contact Sierra Wireless®.
	Flashing Amber	Traffic is being transmitted or received over both the WAN interface and the serial port. This behavior only appears if the RV50X is configured to display it. For more information, contact Sierra Wireless®.
ALL	Green LED chase	Radio module reconfiguration/firmware update or Network Operator Switching is in progress.
	Amber LED chase	ALEOS software update is in progress.

A.1.3 LED Indicators for Solar Charge Controllers

The NMS044 solar charge controller has 1 multi-color LED which indicates unit status as shown in this section. The Genasun Lead Acid solar charge controller (*Figure A-4*) is one example; your model may differ slightly.

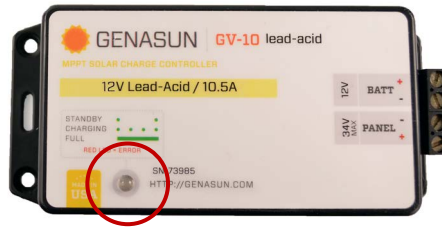

Figure A-4 Example: Genasun Solar Charge Controller



LEARN MORE For LED indication details, see *Table A.5*.

Table A.5 Genasun Solar Charge Controller LED Indication Patterns

● LED Status Indications:	● LED Error Indications:
<p>Standby:</p> <p>The battery is connected properly and ready to charge when solar panel power is available.</p> <p style="text-align: center;"> (2 sec between green blinks)</p>	<p>Overheat</p> <p>The controller's internal temperature is too high.</p> <p style="text-align: center;"> (sets of 2 red blinks)</p>
<p>Charging</p> <p>With low current; less than -3.7 A</p> <p style="text-align: center;"> (fast, short green blinks)</p>	<p>Overload</p> <p>This could be caused by changing the solar panel connections while the charge controller is powered.</p> <p style="text-align: center;"> (sets of 3 red blinks)</p>
<p>Charging</p> <p>With high current; more than -3.7 A</p> <p style="text-align: center;">■ ■ ■ ■ (longer, slower green blinks)</p>	<p>Battery Voltage Too Low</p> <p>The controller cannot begin charging due to low battery voltage. If the nominal battery voltage is correct (12V), charge the battery by some other means before use.</p> <p style="text-align: center;"> (sets of 4 red blinks)</p>
<p>Battery Charged</p> <p>The battery is in the absorption or float charging stage.</p> <p style="text-align: center;">■■■■■■■■■■ (solid green LED)</p>	<p>Battery Voltage Too High</p> <p>If the battery voltage is correct (12V), check the functioning of other chargers that may be connected to the system.</p> <p style="text-align: center;"> (sets of 5 red blinks)</p>

● LED Status Indications:	● LED Error Indications:
	<p>Panel Voltage Too High</p> <p>Only 12V nominal solar panels may be used with this controller.</p> <p> (sets of 6 red blinks)</p>
	<p>Internal Error</p> <p>Contact your dealer</p> <p> (2 long blinks, then any number of short blinks)</p>

A.2 Shipping and Storage Requirements

The box and packing foam your system arrived with is designed to be reused. We recommend that you retain the packaging for future shipments.

A.2.1 Shipping the System

If you need to ship your system, be aware that the LiFePo Battery (BAT019) is considered Class 9 Hazardous Material. The shipping vendor and you are required by law to follow specific protocol when shipping. One requirement is that a company and/or individual must be 49 CFR and IATA certified to ship a lithium battery with over 100 Watt-hour capacity. Recertification is required every 2 years

Prior to shipping the system, always disconnect the battery from the power block terminal. The battery can be shipped in the case when you affix appropriate shipping labels on the outside of the box.

CAUTION Do not transport with lid open. Only those with appropriate certification may ship batteries.

LEARN MORE Licensing can be obtained through a training course, such as the Lion Technology online training course - code #HMT 254 “Shipping Lithium Batteries.”

A.2.2 Preparing the System for Long Term Storage

If you plan to store the system for more than one week, unplug and remove the battery from the case.

A.2.3 Removing Cables From the Case

If the cables need to be removed from the case, follow these steps.

Step 1. Remove the CBL228-03 from the charge controller by unscrewing the terminals and gently pulling the cable out. Remove the CBL222-08 from the top of the 831C by pressing the release button and pulling out.

Step 2. Unscrew the gasket by turning counterclockwise.

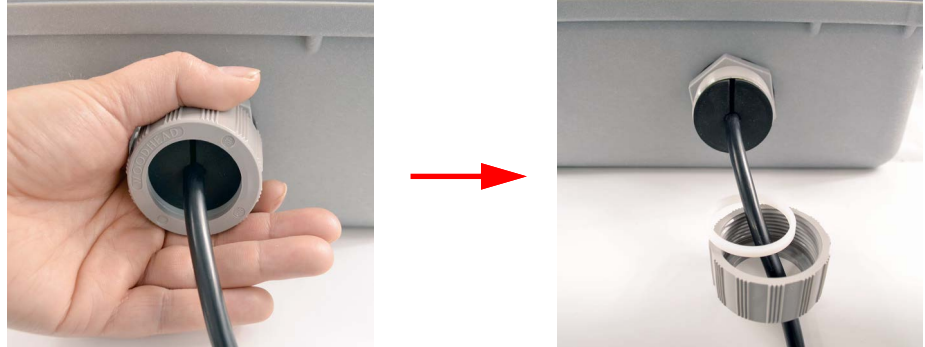

Step 3. Using your hands on either side of the case wall, gently push the rubber stopper out. The cable can be removed through the slit in the stopper.



Step 4. If needed, follow the steps in reverse order to reinstall the cables in the case.

A.3 Understanding 831C SLM Connections

The 831C SLM ships assembled with all required connections in place. This section shows the SLM connections from *Figure 2-1 on page 10* in greater detail.

There are 2 preamplifier options for the SoundAdvisor™ 831C. The PRM2103 (see *Figure A-6*) is used for outdoor measurement, while the PRM831 (see *Figure A-7*) is most often used for indoor measurements.

Figure A-6 Wiring Diagram for PRM2103 in the Case

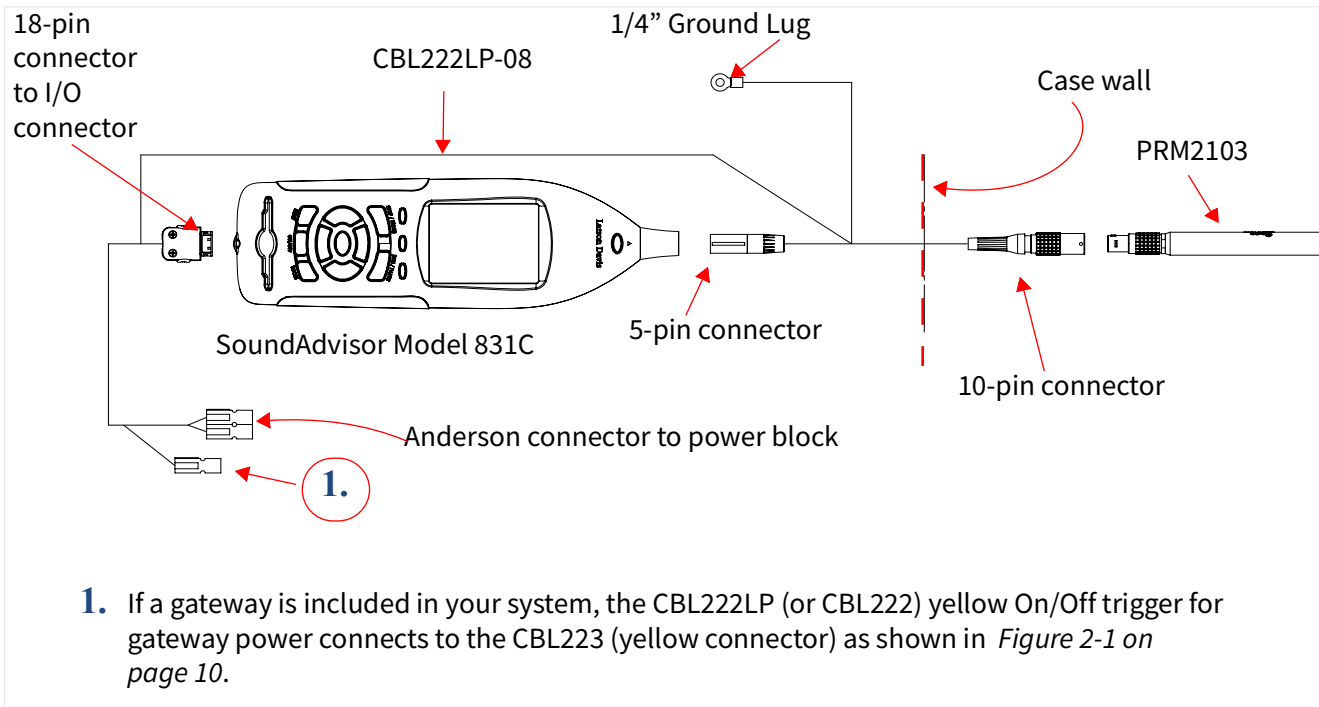
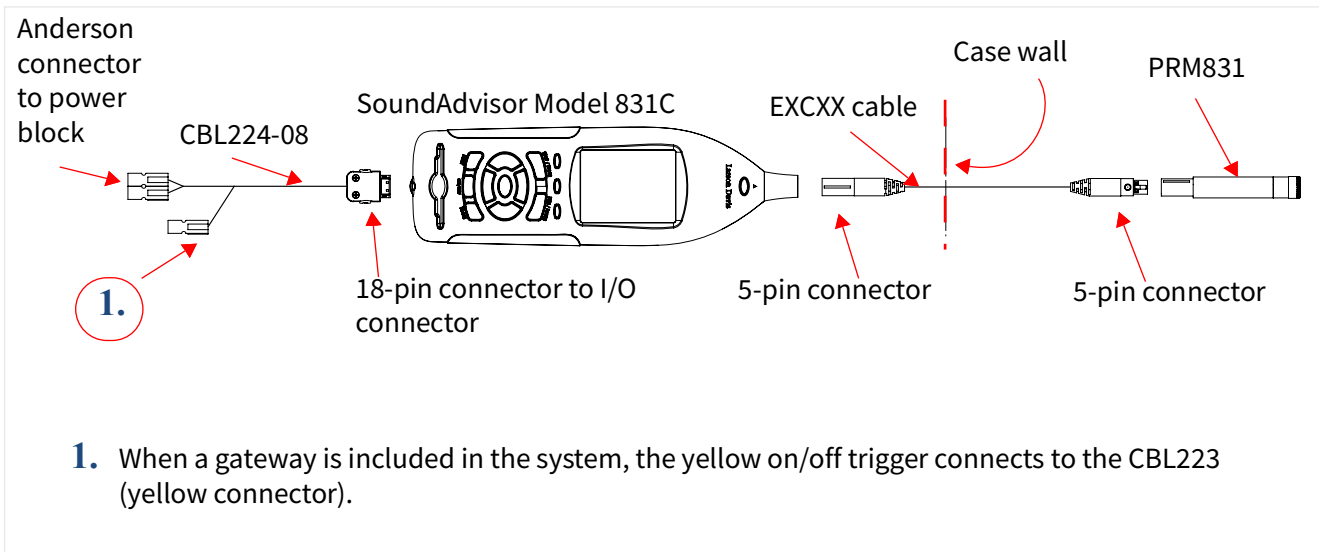

Figure A-7 Wiring Diagram for PRM831 in the Case



A.4 Updating NMS044 for Modem Low Power

When enabled for modem low power, the gateway is powered down except when the 831C SLM powers it on to send alert notifications. If this pattern of use is consistent with your requirements, modem low power can extend the system power supply.

This feature requires the CBL222LP gateway power cable from Larson Davis, and 831C SLM firmware version 4.5 or later, as explained in the following sections.

Before you begin:

- Check the cable tag (label) near the preamp end of your 831C. If the cable is “CBL222LP-XX,” the system is equipped to use this feature; jump to **A.4.3 Enabling Modem Low Power**. If the cable is “CBL222-XX,” complete each section below in the order it’s presented to upgrade your system.

In this section:

- **A.4.1 Installing the Modem LP Cable**
- **A.4.3 Enabling Modem Low Power**

A.4.1 Installing the Modem LP Cable

- Step 1.** Contact your Larson Davis representative (or Larson Davis, as shown on the back cover of this manual) to order the modem low power cable (CBL222LP).
- Step 2.** Open the system case and replace CBL222 with CBL222LP. For reference, see *Figure 2-1 on page 10*.

A.4.2 Upgrading 831C SLM Firmware

If you purchased your NMS system some time ago, Larson Davis periodically releases firmware upgrades with significant security and feature benefits, such as modem low power.

To take advantage of these benefits, install the latest version of G4 LD Utility, connect your 831C to your PC, and upgrade your SLM firmware, as shown in the SoundAdvisor 831C Manual.

To locate and install the latest version of G4, navigate in a browser to **www.LarsonDavis.com/G4**

A.4.3 Enabling Modem Low Power

When enabled for modem low power, the gateway is powered down except for the following periods:

- when the 831C SLM powers it on to send alert notifications
- when the SLM sends a file to the cloud (SFTP, Dropbox, etc.)
- During the scheduled awake period (System Properties → Other page)

You can complete this process by using G4 LD Utility on a PC or the LD Atlas app for mobile. If the system is deployed and you are using LD Atlas, you will need cellular service to connect.

Before you begin:

- Complete section [A.4.1 Installing the Modem LP Cable](#) and [A.4.2 Upgrading 831C SLM Firmware](#).

Step 1. Launch G4 LD Utility on your PC.

Step 2. Click on the name of your connected meter in the Meters Panel. This opens the meter window on the left.

Step 3. Choose **Live View**  → **Tools**  → **System Properties**.

Step 4. On the System Properties page, select the **Menu icon** , then select **Other**.

Figure A-8 System Properties→Other

Step 5. The gateway is connected by using the SLM Logic Out via the AUX port. From the **Logic Out** drop-down menu, select **Modem**.

Step 6. In the **Wake Time** field, enter the time of day the gateway will power on. Wake Time should be local time for the NMS system.

Step 7. In the **Duration** field, select the length of time after the Wake Time that the gateway will be active. The Wake Time plus the Duration defines a specific period of each day, during which the noise monitor can be remotely accessed.

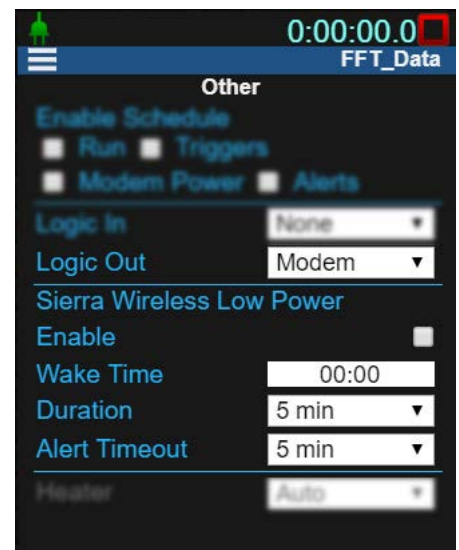

Step 8. If you plan to enable alert notifications, select a time from the **Alert Timeout** drop-down menu. This is the amount of time the modem remains on after sending an alert notification. This includes time to respond to an alert, if needed. If an alert notification is sent directly following a measurement, the Alert Timeout period is in addition to the Duration.

LEARN MORE For more information about setting alert notifications through your 831C account, open the *G4 LD Utility Manual*, Module 6.1. To do this in G4, go to **Help** → **Manuals** → **G4 LD Utility Manual**.

Step 9. Finally, select the checkbox in-line with **Enable** and select **Close** to save the changes. Your system is configured to use modem low power. See *Table A.9* for examples of typical power consumption.

Table A.9 Example: Low Power Mode vs Standard Power

Power Mode	Configuration	Continuous Run Time
Standard	System continuously running, gathering data, gateway idle 23 hours/day, streaming 1 hour/day	2.5 days

Table A.9 Example: Low Power Mode vs Standard Power (Continued)

Low Power	System continuously running, gathering data; gateway in Low Power Mode 23 hours/day, streaming 1 hour /day	6.25 days
This example was calculated using the SLA battery (BAT019)		

A.5 Configuring the Gateway for Larson Davis Instruments

CAUTION Complete this section ONLY if you purchased a new RV50X cellular gateway from someone other than Larson Davis, or if it has been reset to factory default settings.

Larson Davis modifies the Sierra Wireless RV50X gateway configuration to conserve power, increase security, and provide additional services. If you purchased an RV50X gateway from someone other than Larson Davis, or if it has been reset to factory defaults, you will need to reenter these important modifications before using it in the NMS system. To do this you may use a Larson Davis Settings Template file or manually configure the settings as shown in this section. The following list describes how the template file prepares the gateway for use with Larson Davis instruments:

Power Savings

- Ping response is disabled to prevent unauthorized traffic (hackers) from repeatedly accessing the gateway—a potential source of wasted power
- Ethernet and serial ports are disabled to conserve power

Security Enhancements

- SSH and DMZ Host are disabled, which increases system security by blocking potential sources of unauthorized access
- The gateway routes HTTPS communications through the secure HTTP socket to prevent unauthorized “listening”
- The gateway uses a unique port for local, and for remote access, to discourage unauthorized access

Additional Services

- With an installed GPS antenna, the gateway streams the location (and time in local time when at least 4 satellite signals are available).

In this section:

- [**A.5.1 Logging In to ACEmanager**](#)
- [**A.5.2 Configuring LD Settings Utilizing the Template File**](#)
- [**A.5.3 Configuring LD Settings Without the Template File**](#)

- Step 1.** Attach the included USB to mini-B cable from the PC to the gateway. See **Figure 2-7 "Connecting to RV50X" on page 15.**
- Step 2.** Open a web browser, and enter **<http://192.168.14.31:9443>** in the address field.
- Step 3.** Enter the factory default **User Name** and **Password**, and log in to ACEmanager.
TAKE NOTE The factory default user name and password are labeled on the bottom of the RV50X gateway. To view this, remove the RV50X gateway from the base plate, as shown in *Figure 2-5 Removing the Gateway From the Case Plate*. If no label is present on the bottom of the modem, the default password is "12345".
- Step 4.** Take note of the device's firmware version. If needed, update to the latest version.

Updating Firmware to the Latest Version (Recommended)

- In a browser, go to **<http://source.sierrawireless.com/>**.
 - Select the name of your device, then select **Firmware Package**.
 - If needed, download and update the firmware according to the manufacturer's instructions.
- Step 5.** Log in again when the system is rebooted as shown in step 3–4.
- Step 6.** Change your password as shown in the following process.

Changing Your Password:

- Navigate to the **Admin** tab.
- Enter the factory default **User Name** and **Old Password**.

Figure A-10 Admin Tab

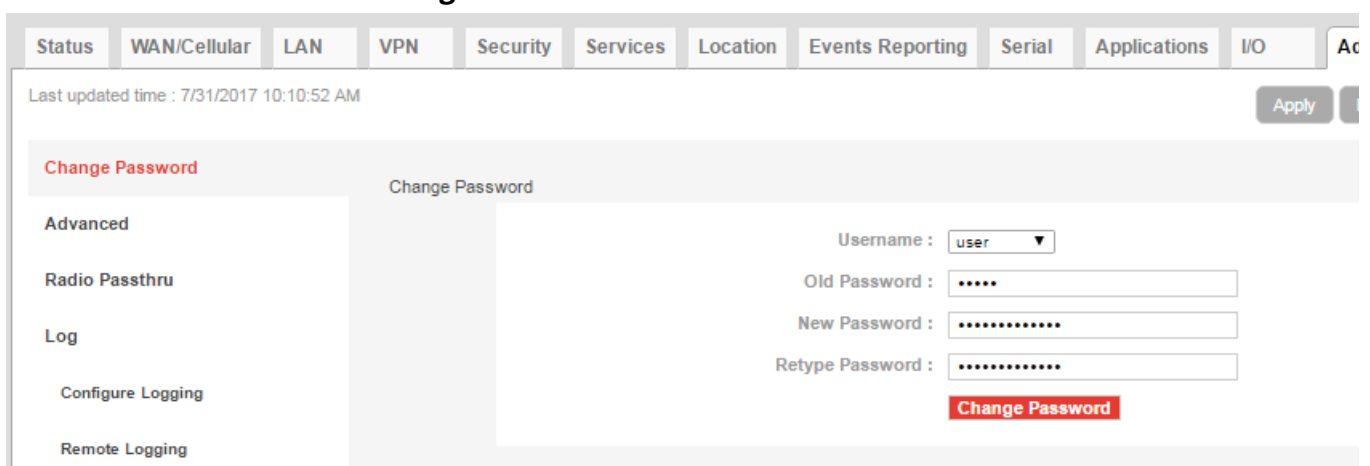

The screenshot shows the ACEmanager web interface. At the top, there is a navigation bar with tabs: Status, WAN/Cellular, LAN, VPN, Security, Services, Location, Events Reporting, Serial, Applications, I/O, and Admin. Below the navigation bar, the page title is "Change Password" and the subtitle is "Change Password". The form contains the following fields:

- Username: user (dropdown menu)
- Old Password: [masked with dots]
- New Password: [masked with dots]
- Retype Password: [masked with dots]

At the bottom of the form, there is a red "Change Password" button. On the left side of the page, there is a sidebar menu with the following items: Advanced, Radio Passthru, Log, Configure Logging, and Remote Logging. At the top left of the page, it says "Last updated time : 7/31/2017 10:10:52 AM". At the top right, there is an "Apply" button.

- Enter a unique password in **New Password**, and again in **Retype Password**.
- Record your password. If you forget it you will need to reset the RV50X to factory settings and complete this process again.
- Click **Change Password**, then click **Apply**.

Recommended Next Step:

Choose one of the following sections:

- [A.5.2 Configuring LD Settings Utilizing the Template File](#)
- [A.5.3 Configuring LD Settings Without the Template File](#)

A.5.2 Configuring LD Settings Utilizing the Template File

Utilizing the LD settings template file is the fastest and simplest method of configuring the gateway.

Step 1. Log in to ACEmanager as shown in [A.5.1 Logging In to ACEmanager on page A-11](#).

Step 2. Select **Template** in the top right. This opens the Template upload window.

Figure A-11

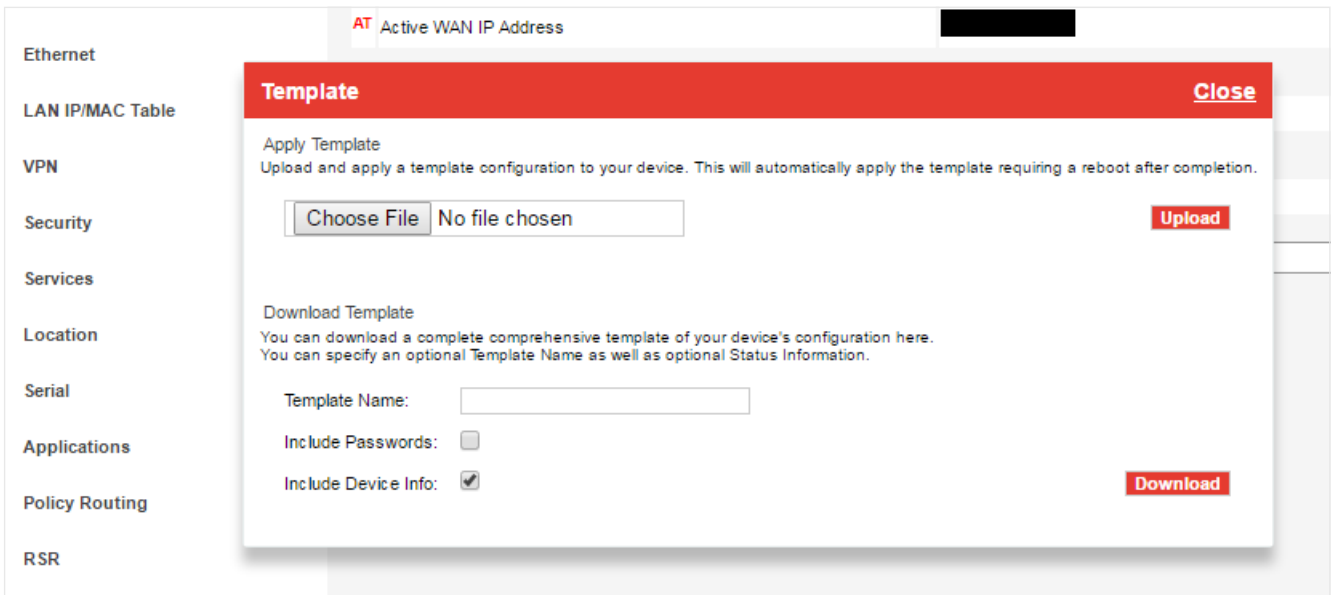

Step 3. To upload the RV50X configuration template, do the following:

- Download the “**RV50XTemplateFile.xml**” from the [Larson Davis NMS044 Product Page](#). Then click **Choose File**, select the downloaded template file, and click **Upload**.

Step 4. Select **Apply**. The gateway configuration is complete.

A.5.3 Configuring LD Settings Without the Template File

If you purchased your RV50X gateway from someone other than Larson Davis, or if your gateway has been restored to factory default settings, you need to configure it for use with Larson Davis instruments. You may manually configure the RV50X gateway for use with Larson Davis instruments, as shown in this section.

Step 1. Log in to ACEmanager as shown in [A.5.1 Logging In to ACEmanager](#).

- Step 2.** Choose the **WAN/Cellular** menu, **Ping Response** sidetab; edit the values to match *Figure A-12* and click **Apply**.

Figure A-12 Edit the Ping Response

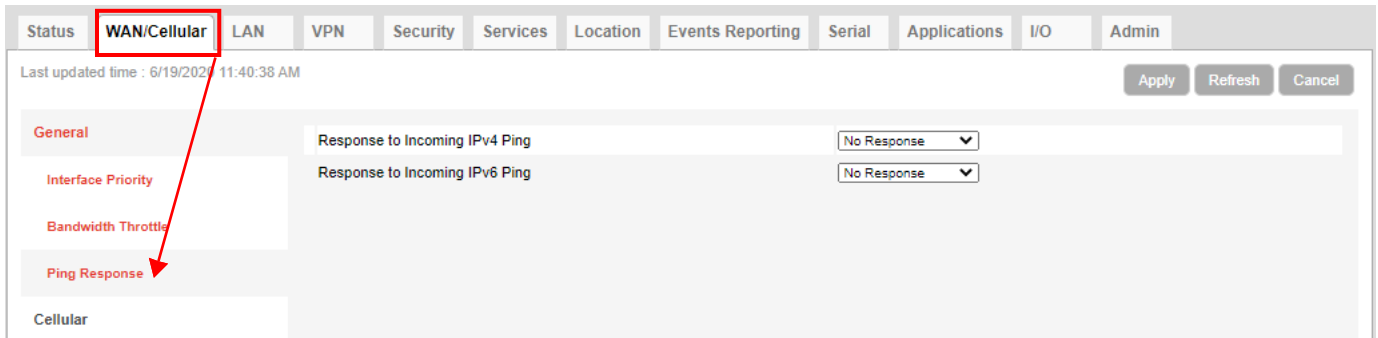

- Step 3.** Choose the **Security** menu, **Port Forwarding** sidetab.

- Step 4.** Edit the values to match what is shown in *Figure A-13*, and click **Apply**.

Figure A-13 Edit Port Forwarding Settings

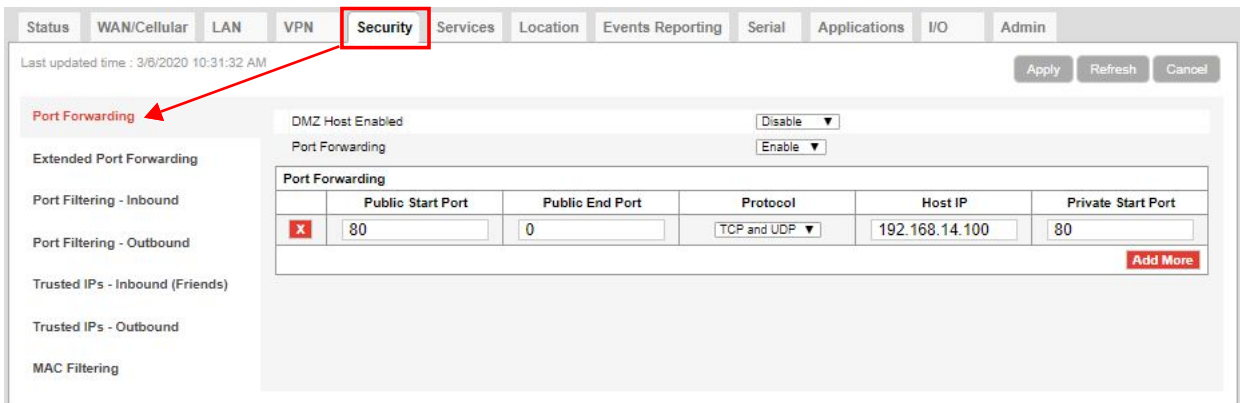

- Step 5.** To provide gateway security, complete the following process.

- Choose the **Services** menu, **ACEmanager** sidetab.
- Edit the **General** values to match *Figure A-14* and click **Apply**.

Figure A-14 Services - ACEmanager

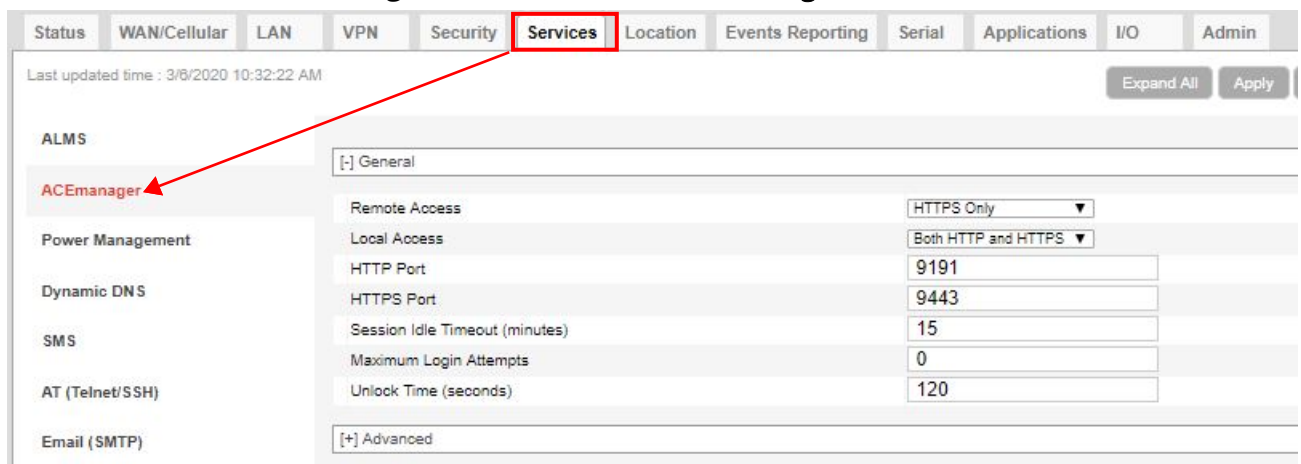

- Step 6.** To configure the gateway to make the best use of available power, complete the following process.

Configuring Power Management

- Click the **Power Management** sidetab, and expand the **Power Saving Modes** menu.

- b. From the **Processor Power Saving Mode** drop-down, select **Enable** and click **Apply**.

Figure A-15 Services - Power Management

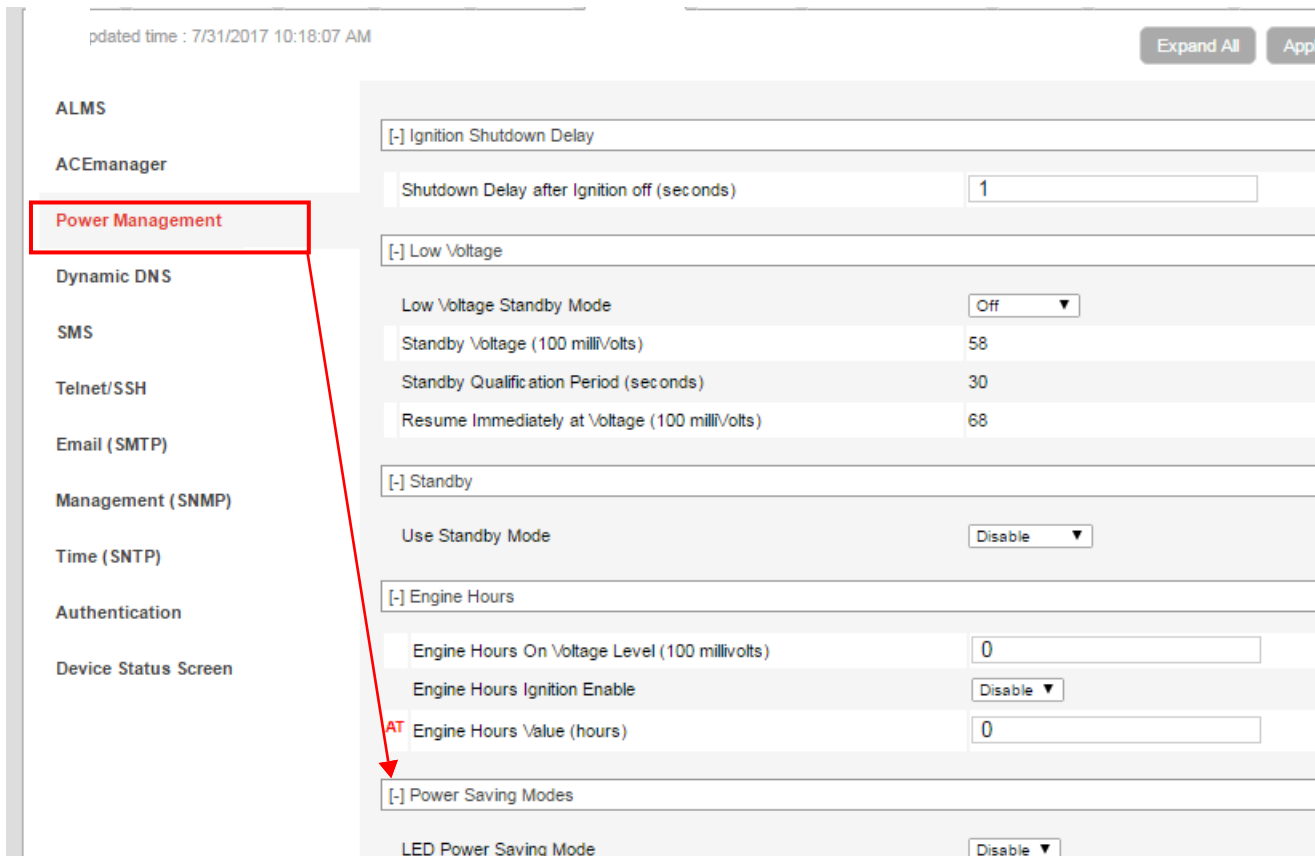

- Step 7.** Select the **Telnet/SSH** sidetab, set **Telnet/SSH Echo** to **Disable** and click **Apply**.

TAKE NOTE This setting increases system security by blocking a potential source of unauthorized access.

Figure A-16 Telnet/SSH

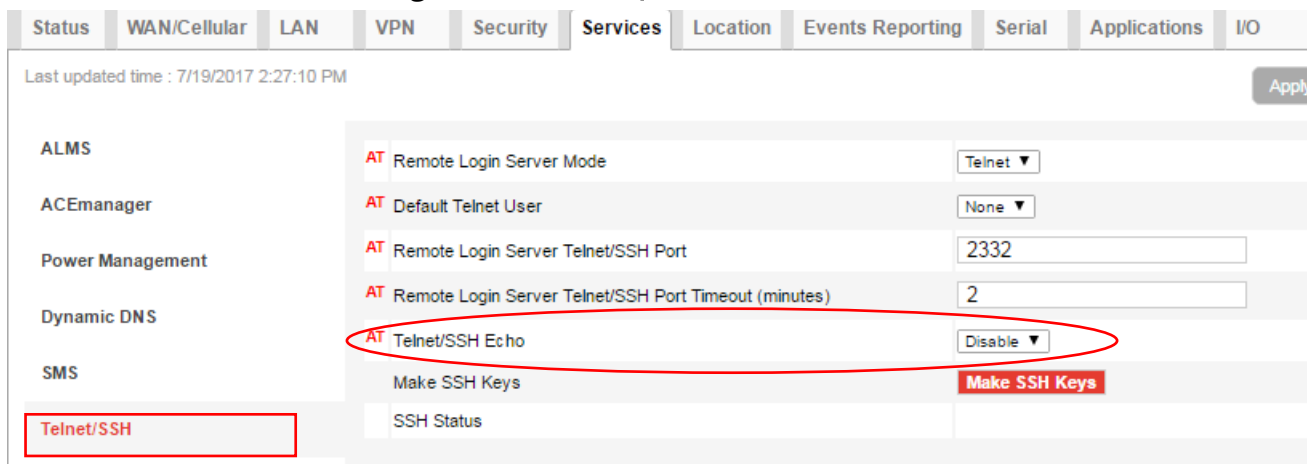

- Step 8.** Select the **Location** menu, **Global Settings** sidetab. Match your settings to those shown in *Figure A-17* and click **Apply**.

Figure A-17 Location Settings

Status WAN/Cellular LAN VPN Security Services **Location** Events Reporting Serial Applications I/O

Last updated time : 5/19/2021 7:46:12 AM Expand All

Global Settings

- Server 1
- Server 2
- Server 3
- Server 4
- Local/Streaming

[-] Location Settings

Location Service Enable ▾

[-] General

AT Odometer Value (meters)

AT TAIP ID

AT Send SnF Buffer immediately on input Disable ▾

AT Use Device ID in Location Reports Disable ▾

[-] Advanced

AT TCP Location Port

Location Fix Mode Standalone ▾

Heading Sensitivity Normal ▾

GNSS Reboot Watchdog Enable ▾

Enable NMEA Logging (GNSS debugging) Disable ▾

GNSS Antenna Bias Enable ▾

GPS No Signal Watchdog (minutes) Disable ▾

Step 9. Choose the **Local/Streaming** sidetab, match the **Serial** and **Local IP Report** values shown in *Figure A-18*, and click **Apply**.

Figure A-18 Local/Streaming Settings

Status WAN/Cellular LAN VPN Security Services Location Events Reporting Serial Applications I/O Adm

Last updated time : 5/18/2021 11:10:02 AM Expand All

Global Settings

- Server 1
- Server 2
- Server 3
- Server 4
- Local/Streaming**

[-] Serial

AT Location Reports port USB Serial ▾

Location Reports Format Predefined ▾

AT Location Reports Type NMEA GGA+VTG+RMC ▾

AT Location Reports Frequency (seconds)

AT Location Coverage ALWAYS ▾

AT Location Reports Delay (seconds)

[-] Local IP Report

AT Local Reporting Time Interval (seconds)

Location Reports Format Predefined ▾

AT Local Report Type NMEA GGA+VTG+RMC ▾

Starting Destination Port

AT Number of Extra Destination Ports

Device ID in Local Reports None ▾

Local Report Destination Mode USBNET ▾

Step 10. Choose the **Serial** menu, open the Port Configuration list, select **Disable** from the **Serial Port** drop-down menu, and click **Apply**.

Figure A-19 Serial Port Settings

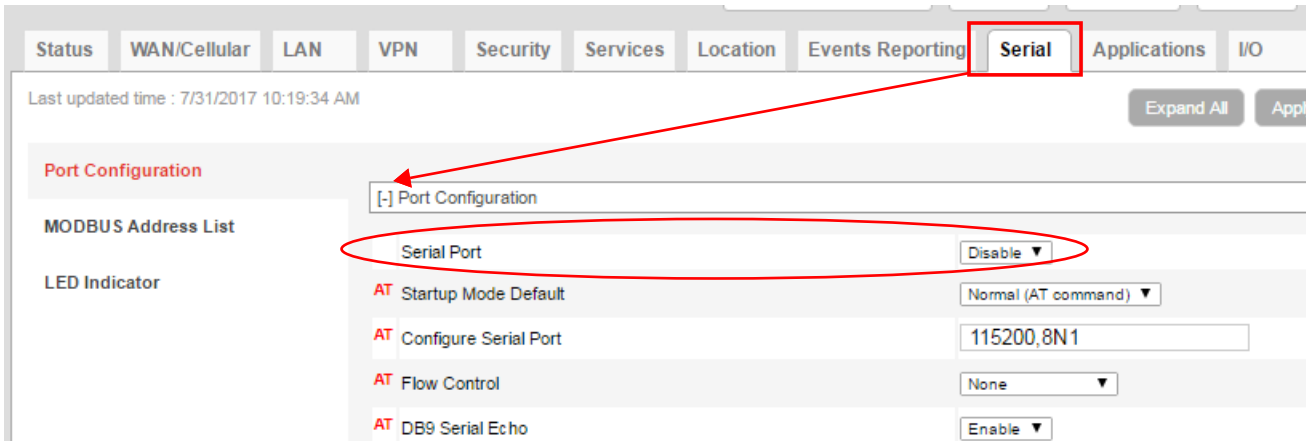

Step 11. Select the **LAN** menu, **USB** sidetab; verify that the settings are as shown in Figure A-20, and click **Apply**.

Figure A-20 USB Port Settings

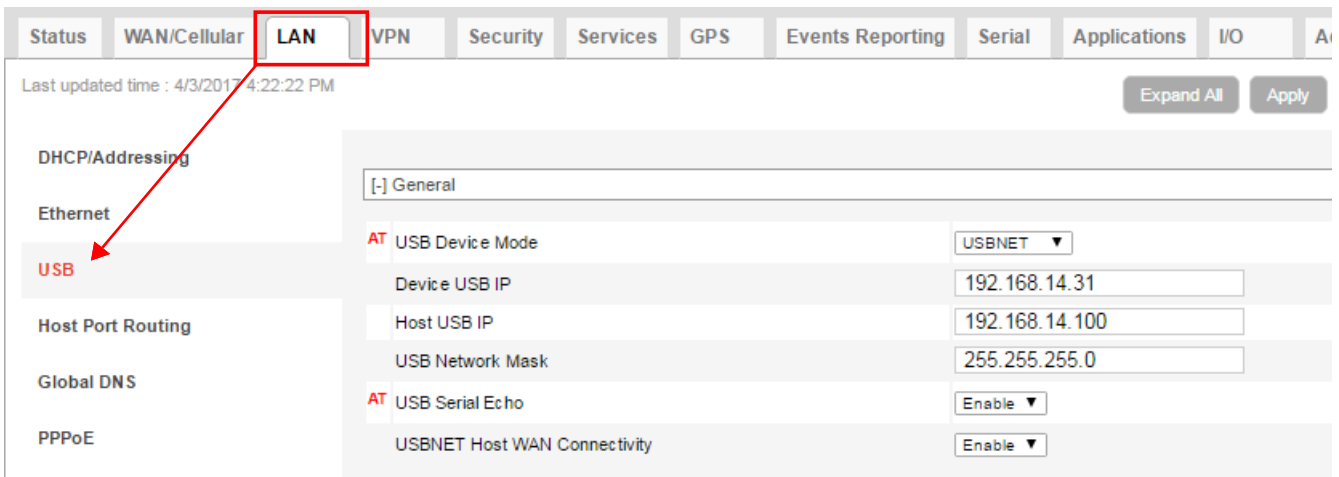

Step 12. Select the **I/O** menu, **Configuration** sidetab; verify that the settings are as shown in Figure A-21, and click **Apply**.

Figure A-21 Settings on the I/O Tab

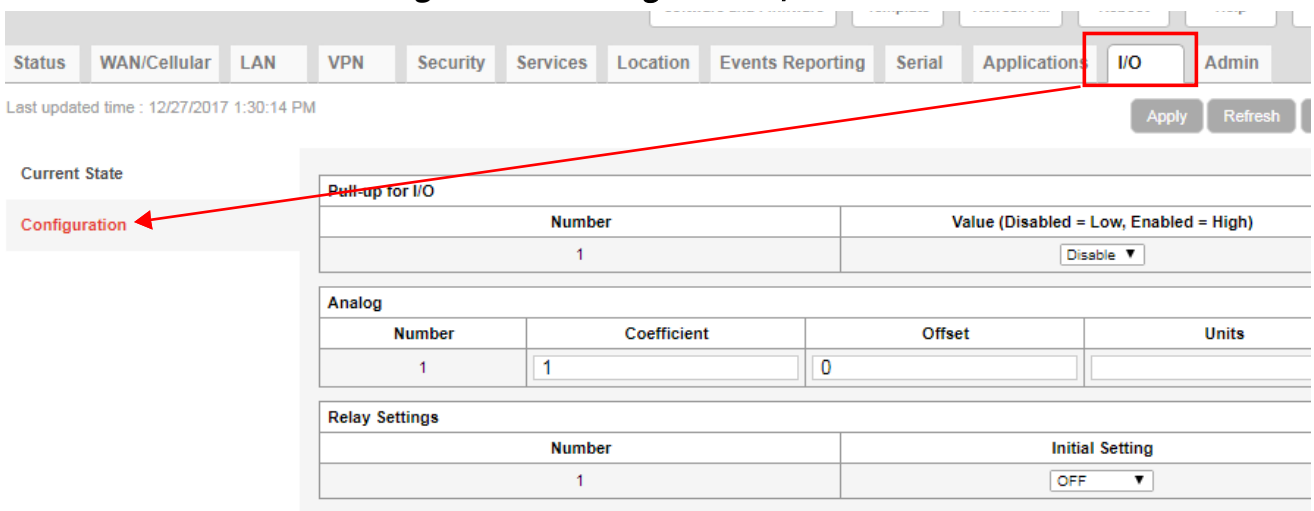

Step 13. Select the **LAN** menu, **Ethernet** sidetab.

TAKE NOTE After this change you will not be able to connect to the gateway with a wired Ethernet connection. If you need to restore the wired connection

without connecting to the gateway through the cellular connection, do a hard reset on the gateway. This resets all items to the factory defaults. If you want to use a cellular connection once again, you will need to repeat the process in this section from step 1.

Figure A-22 LAN Settings

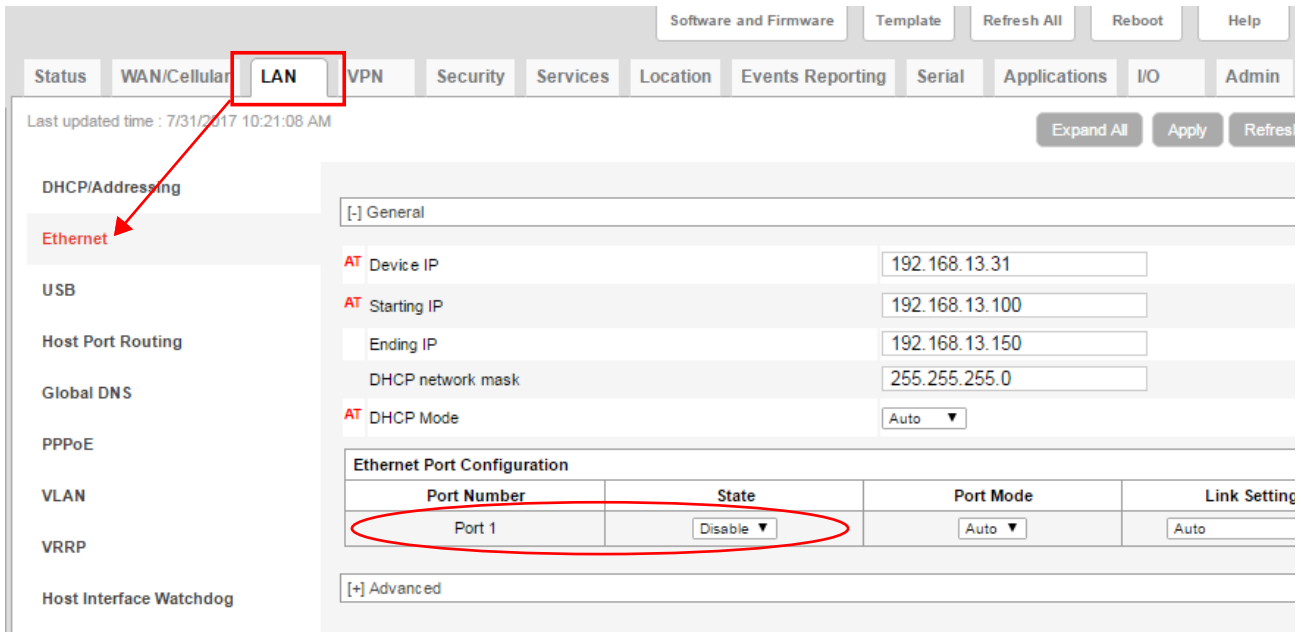

Step 14. In the **Ethernet Port Configuration** section, change the **Port 1 State** to **Disable**, and click **Apply**.

Step 15. Click the **Reboot** button in the top right. The gateway saves your settings and reboots. It may take up to 3 minutes for the reboot.

B.1 Physical Characteristics

Table B.1 Weight by Package and by Component

Full Package	
NMS044 with 100W solar panel (SLP002), LiFePo Battery, and cases	26.27 kg (58 lbs)
Components	
NMS044 only	8.18 kg (18 lbs)
100 Watt solar panel only (SLP002)	12.27 kg (27.05 lbs)
Telescoping pole, mic shroud, and mic/preamp combo in bag	1.92 kg (4.2 lbs)
LiFePo Battery (BAT019)	5.8 kg (12.8 lbs)
SLA Battery (BAT021)	11.2 kg (24.7 lbs)

Table B.2 Dimensions by Component

NMS044 Case	61 cm x 35.5 cm x 18 cm (24" x 14" x 7")
100 W Solar Panel (SLP002)	50 cm x 68.5 cm x 8 cm (20" x 27" x 3")
Canvas Bag	48 cm x 23 cm x 15 cm (19" x 9" x 6")

DEPLOYMENT SPACE REQUIREMENTS

The NMS044 system, when deployed, requires a 3 m (10-foot) diameter on the ground, with a 2 m (6.5-foot) overhead clearance minimum. Since sound reflections are possible when other large objects are nearby, we recommend additional clearance.

RECOMMENDED SOLAR PANELS

If you use solar panels other than those provided from Larson Davis, the NMS system can support solar panels providing up to 140 Watts.



GMGA MEASURING

Address: No. 33 Alley 99/120 Dinh Cong Ha, Dinh Cong Ward, Hoang Mai District, 10000 Hanoi City, Vietnam

Telephone: [+84 845 969 336](tel:+84845969336)

Email: info@gmga.vn

Website: <https://gmga.vn/>